



# GTV

PRODUKTKATALOG

CATALOGUE DE PRODUITS

CATÁLOGO DE PRODUCTOS

[gtv.com.pl](http://gtv.com.pl)

MÖBELBELEUCHTUNG  
ÉCLAIRAGE DE MEUBLES  
ILUMINACIÓN PARA MUEBLES

SCHIEBETÜRSYSTEME  
SYSTÈMES DE PORTES COULISSANTES  
SISTEMAS DESLIZANTES

DEKORATIVES ZUBEHÖR  
ACCESSOIRES DÉCORATIFS  
ACCESORIOS DECORATIVOS

FUNKTIONSZUBEHÖR  
ACCESSOIRES FONCTIONNELS  
ACCESORIOS FUNCIONALES



DE

GTV ist ein Produzent und internationales Vertriebsunternehmen für Möbelzubehör und Beleuchtung. Es ist eines der sich am dynamischsten entwickelnden Unternehmen in Polen. Das Unternehmen ist auf mehreren Dutzend Märkten in Europa, Asien und Amerika präsent, und Produkte mit dem GTV-Logo sind in Millionen von Wohnungen und Büros auf der ganzen Welt zu finden. GTV ist ein zu 100% polnisches Unternehmen. Das Unternehmen verfügt über eigene technische und logistische Einrichtungen, die es ermöglichen, seine Geschäfte weltweit frei zu führen. Der Sitz des Unternehmens ist ein modernes, voll computergesteuertes Logistikzentrum in Pruszków, in der Nähe der Autobahn A2. Ab Mai 2023 arbeiten wir in einem neuen Distributionszentrum mit 30.000 m<sup>2</sup> Lagerfläche der Klasse A und 1.500 m<sup>2</sup> Bürofläche. Dies gibt uns die Möglichkeit einer weiteren Expansion bis auf 64.000 m<sup>2</sup>. Das Portfolio von GTV ist eines der vollständigsten auf dem Markt. Es umfasst mehrere Tausend Produkte in mehreren Dutzend Produktgruppen, darunter: Scharniere, Führungen, Klappenbeschläge, Möbelgriffe und -knöpfe, Ausstattung von Garderoben und Küchen sowie LED-Beleuchtung.

FR

GTV est un distributeur international d'accessoires d'ameublement et d'éclairage. C'est l'une des entreprises les plus dynamiques de Pologne. La société est présente sur plusieurs dizaines de marchés en Europe, en Asie et en Amérique, et les produits portant le logo GTV sont présents dans des millions de foyers et de bureaux dans le monde entier. GTV est une société 100% polonaise. L'entreprise dispose de ses propres installations techniques et logistiques, ce qui lui permet de mener ses activités dans le monde entier de manière libre. Le siège de l'entreprise est dans un centre logistique moderne et entièrement informatisé à Pruszków, près de l'autoroute A2. À partir de mai 2023, nous travaillons dans un nouveau centre de distribution avec 30 000 m<sup>2</sup> d'entrepôts de classe A et 1 500 m<sup>2</sup> de bureaux. Centre nous donne la possibilité d'une extension supplémentaire à 64 000 m<sup>2</sup>. Le portefeuille de GTV est l'un des plus complets du marché. Il couvre plusieurs milliers de produits, dans plusieurs dizaines de groupes de produits, y compris : charnières, glissières, dispositifs d'ouvertures, poignées, équipements garde-robes et cuisines et éclairage LED.

ES

GTV es un distribuidor internacional de accesorios e iluminación para muebles. Es una de las empresas con mayor desarrollo en Polonia. La compañía está presente en decenas de mercados en Europa, Asia y América, y los productos con el logotipo de GTV se encuentran en millones de hogares y oficinas de todo el mundo. GTV es una empresa 100% polaca. La empresa dispone de sus propias instalaciones técnicas y logísticas que le permiten llevar a cabo sus instalaciones en todo el mundo. La sede de la empresa se encuentra en un moderno centro logístico totalmente informatizado en Pruszków, cerca de la autopista A2. A partir de mayo de 2023 trabajamos en un nuevo centro de distribución, que cuenta con 30.000 m<sup>2</sup> de almacén de clase A y 1.500 m<sup>2</sup> de oficinas. El centro nos ofrece la posibilidad de ampliarlo a 64.000 m<sup>2</sup>. Nuestro catálogo es uno de los más completos del mercado, compuesto por miles de productos, ordenados por categorías, entre los que se incluyen: bisagras, guías, elevadores, tiradores equipos para guardarropa y cocias e iluminación LED.





## GTV

FURNITURE  
ACCESSORIES

- DE** GTV Furniture Accessories, eine Marke, die seit mehr als zwanzig Jahren auf dem Markt präsent ist, ist der unumstrittene polnische Marktführer mit dem umfassendsten Sortiment von Möbelbeschlägen für die Möbelbranche. Dank einer durchdachten Entwicklungsstrategie bietet die Marke ein für andere Unternehmen unerreichtes Preis-Leistungs-Verhältnis und liefert funktionale und zukunftsweisende Produkte zu erschwinglichen Preisen.
- FR** GTV Furniture Accessories, marque présente sur le marché depuis plus de vingt ans, est le leader incontesté dans la fourniture de la gamme d'accessoires la plus complète dans le secteur du meuble. Grâce à une stratégie de développement adaptée, la marque offre un rapport qualité/prix inatteignable pour les autres entreprises ; elle fournit des produits fonctionnels et avant-gardistes à des prix abordables.
- ES** GTV Furniture Accessories, marca presente en el mercado desde hace más de veinte años, es líder indiscutible en el suministro de la más completa gama de accesorios para la industria del mueble. Gracias a una estrategia de desarrollo bien pensada, la marca ofrece una relación calidad/precio inalcanzable para otras empresas, ofreciendo productos funcionales y que marcan tendencia a precios asequibles.

- DE** GTV Sliding Door Systems ist eine Marke, die 2014 für Profis geschaffen wurde, die nach Lösungen suchen, die den Einbau von Schiebetüren erleichtern und beschleunigen. Die Schiebetürsysteme wurden von unseren Designern entworfen, die sich von den Meinungen polnischer Tischler inspirieren ließen. Dank dieser fruchtbaren Zusammenarbeit haben wir ein Produkt entwickelt, das nicht nur durch praktische, strukturelle Verbesserungen überzeugt. Es sind gerade die Details, die den Produktvorteil ausmachen, wie z.B. das einzigartige Material, aus dem die Räder in den Laufsystemen gefertigt werden.
- FR** GTV Sliding Door Systems est une marque créée en 2014 pour les professionnels à la recherche de solutions facilitant et accélérant l'installation des portes coulissantes. Les systèmes coulissants ont été conçus par nos designers, qui se sont inspirés de l'expérience des menuisiers polonais. Grâce à cette coopération fructueuse, nous avons développé un produit avançant pas uniquement par des améliorations pratiques et structurelles. Mais également par des détails qui procurent un avantage du produit, tel que le matériau unique avec lequel sont fabriquées les roues dans les systèmes de roulement.
- ES** GTV Sliding Door Systems es una marca creada en 2014 para profesionales que buscan soluciones que facilitan y agilizan la instalación de puertas correderas. Los sistemas deslizantes están diseñados por diseñadores propios, en colaboración con carpinteros polacos. Gracias a esta fructífera relación, hemos desarrollado un producto que no sólo convence por sus mejoras prácticas y estructurales, sino también por sus detalles que marcan las ventajas del producto, como el material exclusivo con el que se fabrican las ruedas de los sistemas deslizantes.

- DE** Die Marke GTV Lighting startete 2007 mit Beleuchtungslösungen auf LED-Basis für Büros, Industrieobjekte, Lagerhallen und öffentliche Gebäude. Das Portfolio umfasst auch LED-Produkte für individuelle Kunden: LED-Leuchtmittel sowie Möbelbeleuchtung. GTV Lighting bietet ein breites und vollständiges Angebot, Flexibilität bei der Zusammenarbeit mit Geschäftspartnern sowie zuverlässigen Service.
- FR** La marque GTV Lighting a été lancée en 2007 avec des solutions d'éclairage pour les bureaux, les bâtiments industriels, les entrepôts et les bâtiments publics basés sur la technologie LED. La gamme comprend également des produits LED pour les clients individuels - sources LED, éclairage de meubles. GTV Lighting est une offre large et complète, flexible dans son approche commerciale ainsi que pour le service.
- ES** La marca GTV Lighting fue lanzada en 2007 con soluciones de iluminación para oficinas, edificios industriales, almacenes y edificios de servicios públicos basados en la tecnología LED. Nuestra oferta también incluye productos LED para clientes individuales - Iluminación LED para el hogar e iluminación LED para muebles. GTV Lighting cuenta con una oferta amplia y completa, flexibilidad en el acercamiento a los socios comerciales, así como el servicio.

- DE** GTV Decor ist eine Marke der dekorativen Beleuchtung, die im Einklang mit den neuesten internationalen Designtrends geschaffen wurde. Unser Ziel ist es, Kunden mit unterschiedlichen Vorlieben zu erreichen und sie bei individuellen Wohnungsprojekten zu unterstützen. Wir liefern dekorative Beleuchtung, die eine qualitative Nutzung des Raums ermöglicht. Wir verfolgen aktuelle Designtrends, in denen der individuelle Stil des Interieurs die Identität des Kunden widerspiegelt. Der Reichtum an Farben und die modischen, ruhigen Farben sorgen dafür, dass jeder das Richtige im GTV DECOR Portfolio findet. Weiße, graue, schwarze Farbtöne, durchdachte Details sowie die Vielfalt von Lampen - all das finden Sie in unseren Produkten, die mehr als 70 Leuchtenmuster umfassen.
- FR** GTV Decor est une marque d'éclairage décoratif, qui a été créée selon les dernières tendances du design mondial. Notre objectif est de gagner des clients avec des préférences différentes et de les soutenir dans leurs projets de logement individuels. Nous fournissons un éclairage décoratif, qui offre un aménagement de l'espace d'une très bonne qualité. Nous suivons les tendances actuelles en matière de design, dans lesquelles le style individuel de l'intérieur reflète l'identité du client. Grâce à une grande variété de motifs et de couleurs discrètes et à la mode, chacune trouvera quelque chose pour soi dans le portefeuille de GTV DECOR. Des nuances de blanc, de gris, de noir, des détails bien pensés et une grande variété de lampes - tout cela se trouve dans nos produits qui comprennent plus de 70 modèles de luminaires.
- ES** GTV Decor es una marca de iluminación decorativa creada de acuerdo con las últimas tendencias del diseño mundial. Nuestro objetivo es llegar a clientes con diferentes preferencias y apoyarlos en tus proyectos individuales de vivienda. Ofrecemos iluminación decorativa que garantiza un uso de calidad del espacio. Seguimos las tendencias actuales de diseño, en las que el estilo individual del interior refleja la identidad del cliente. Una amplia gama de diseños y colores modernos y tenues hacen que el portafolio de GTV DECOR tenga algo para todos. Tonos blancos, grises, negros, detalles cuidados y una gran variedad de lámparas: todo esto se puede encontrar en nuestros productos, que incluyen más de 70 diseños de luminarias.

## FUNKTIONSBESCHLÄGE ACCESSOIRES FONCTIONNELS ACCESORIOS FUNCIONALES

Scharniere Charnières Bisagras	66 – 107
Türdämpfer und Druckschnäpper Amortisseurs Amortiguadores	108 – 113 / 124 – 126
Klappenbeschläge Systèmes d'ouvertures Elevadores	114 – 123
Führungen Glissières Guías	128 – 163
Schubladensysteme Systèmes de tiroirs Sistemas de cajones	166 – 216
Verbindungselemente Éléments de raccord Elementos de conexión	221 – 250
Leisten Bandes Barras	251 – 253
Befestigungen für Rohre Fixation tuyaux Fijaciones para tubos	254 – 269
Garderobenausstattung Équipement de garde-robe Equipamiento para guardarropas	270 – 293
Küchenzubehör Accessoires de cuisine Accesorios de cocina	218 – 221 / 294 – 319
Büromöbelzubehör Accessoires de bureau Accesorios para escritorio	320 – 332
Sonstige Autres Otros	333 – 337

## DEKORATIVE BESCHLÄGE ACCESSOIRES DE DÉCORATION ACCESORIOS DECORATIVOS

Möbelgriffe und -knöpfe Poignées Tiradore	340 – 447
Kleiderhaken Suspensions Perchas	448 – 455

Regalwinkel	
Supports d'étagères	
Soportes	456 – 463
.....	
Möbelfüße	
Pieds de meubles	
Patas de muebles	464 – 484
.....	
Tischbeine	
Pieds de meubles	
Patas de muebles	485 – 499
.....	
Möbelrollen	
Roues pour meubles	
Ruedas de muebles	500 – 505
.....	

## **SCHIEBETÜRSYSTEME SYSTÈMES POUR PORTES COULISSANTES SISTEMAS DESLIZANTES**

Unteres Laufsystem	
Châssis inférieur	
Sistema de carril inferior	511 – 540
.....	
Oberes Laufsystem	
Châssis supérieur	
Sistema de carril superior	541 – 545
.....	

## **MÖBELBELEUCHTUNG ÉCLAIRAGE DE MEUBLES ILUMINACIÓN DE MUEBLES**

LED-Streifen	
Rubans LED	
Tiras LED	550 – 555
.....	
Aluminiumprofile für LED-Streifen	
Profils LED	
Perfiles LED	556 – 587
.....	
LED-Leuchten	
Luminaires LED	
Focos LED	588 – 595
.....	
Zubehör	
Accessoires	
Accesorios	596 – 625
.....	
Tisch-Steckdosenleisten	
Multiprises bureau	
Regletas de escritorio	626 – 647

**FUNKTIONSBESCHLÄGE**  
**ACCESSOIRES FONCTIONNELS**  
**ACCESORIOS FUNCIONALES**



69

ZM-OT-STANDARD



69

ZM-HCSL09-3D



70

ZM-HCSL08-3D



70

ZM-HCSL07-3D



71

PZ-HCSL-H0-BE0



71

PZ-HCSL3D-H0-BE0



71

PZ-HCSL-H0-M5



71

ZM-COVERHCSL-SET



71

ZM-DHC09-3DBE0



72

ZM-DHC08-3DBE0



72

ZM-DHC07-3DBE0



73

ZM-ECH09BE0



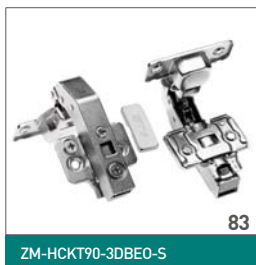





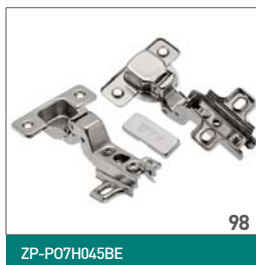





111

AM-PL-DL-M



112

AM-OAM-KR-MG-10



112

AM-OAM-DL-MG-10



113

AM-ZAT-A1-10



113

AMR-BP-1003



114

PD-LIFTNEW-LIGHT-10



114

PD-LIFT-P20-LIGHT-10



115

PD-MINILIFTNEW-LIGHT



116

PD-GAM050-N02



118

PD-G0050-N02



119

PD-G0050-N03



120

PD-G60160-02



121

PD-GPD01-001



122

PD-PD000-001



123

PD-PD000-001B









170

PB-AXISPRO-P20-KPL250C



171

PB-AXISPRO-P20-KPL250D



171

PB-AXISPRO-WEWMOCA



172

PB-AXISPRO-WEWMOCB



172

PB-AXISPRO-WEWMOCC



173

PB-AXISPRO-WEWMOCD



173

PB-AXISPRO-ZESWEW-A AXISPRO



174

PB-AXISPRO-ZESWEW-B AXISPRO



174

PB-AXISPRO-ZESWEW-C AXISPRO



175

PB-AXISPRO-ZESWEW-D AXISPRO



175

PB-AXISPRO-RELKW300



175

PB-AXISPRO-ZNACZ-FRONT



177

PB-MBPRO-KPL300A



177

PB-MBPRO-KPL300B



178

PB-MBPRO-KPL300C





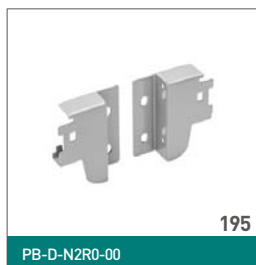
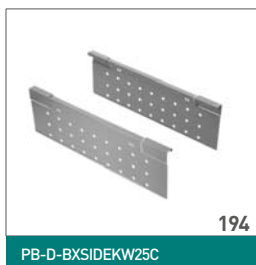

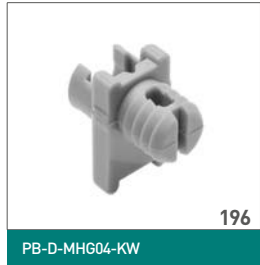

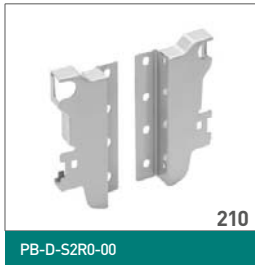
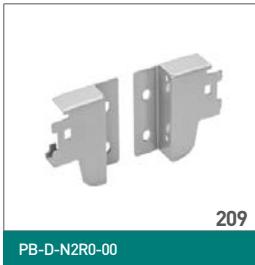
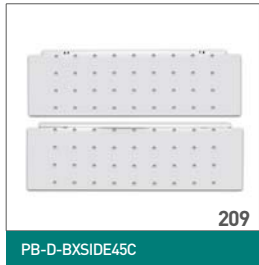
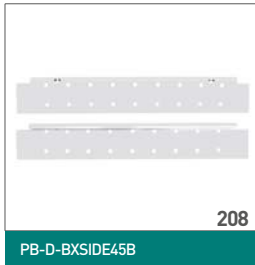



212

PB-D-MHG04



213

PB-D-MBSTAB-00



213

PB-D-KPL68-450-80



214

PB-D-ZLE-450



214

PB-D-ULE-500

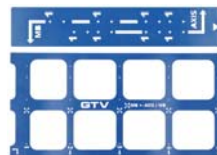

215

PB-SZABLON-AXIS-MB

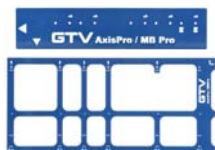

216

PB-SZABLON-AXIS-MBPRO



218

W-CUSTOMI-60L450



218

W-CUSTOMI-60L500



219

W-CUSTOMI-80L450



219

W-CUSTOMI-80L500



220

WK-SZ-AS-400-10



220

MA-MATA-1-10



221

PP-MP0055-01



221

PP-SP0075-01





230

MC-K135-06-01



230

MC-J01A-12-01



231

MC-J04A2-14-01



231

MC-J60A27-01



232

MC-J62-01



232

PP-GL-DR5-01



233

PP-SPL001-01



233

MR-ZSL011-01



234

PP-SMART-000



234

PP-NW09X90B



235

PP-LUK-00-01



235

WB-073024-01



236

WB-073025-01



236

WB-073026-01



237

WB-WS-12-010









245

ZK-FORZA-ZAS-KPL-010



245

LO-M2M-00-125



246

EM-SBL065-01-A



246

MM-FI20X6X7-PL10-A-1T



247

SZ-005-00-01T



247

WK-D0320-001



248

WK-CAM-15-12-D



248

WK-DOW63X45B-D



249

WK-CAM-15-DOW63X45-KPL-1T



249

WK-CF6450-01



250

MG-MENSA-010



250

PM-PFMH51-10

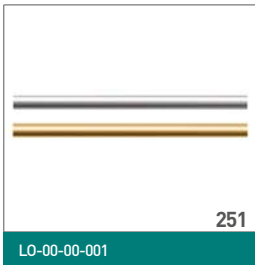

251

LO-00-00-001



251

LMB-BOCZ38L-05



252

LMB-KAT38-05







261

MR-TH004-001



261

MR-TH018-KPL



262

MR-TH009-001



262

MR-TH035-KPL



263

MR-WP-15-KPL



263

MR-TH002-L01



264

MR-TH018-L01



264

MR-THQZ1-001



265

MR-TH019-001



265

MR-TH019-003



266

MR-WP2802-01



266

MR-WP2815-01



267

MR-WP2804-01



267

MR-WP2806-01



268

MR-WP2807-20





268

MR-WPZ023-01



269

MR-WPS01-001



269

MR-WPS03-001



270

WG-KOSZM60-10



271

WG-KOSZ60-10



272

WG-KOSZR60-10



273

WG-POBUW60-10



274

WG-POBUWM60-10



275

WG-PRZEG60-10



276

WG-WSPOD60-10



276

WG-WSPOD60



277

WG-RRPSET-A-10



277

WG-RDRP-10



278

PG-ST83115-10A



280

W-WOBU60-BP-60



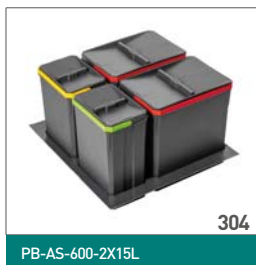

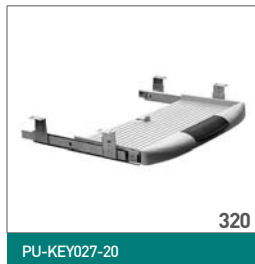
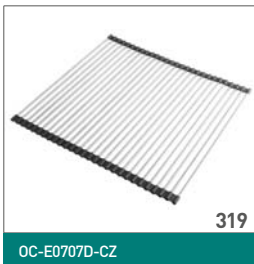

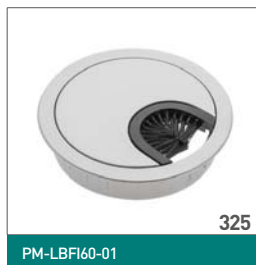





**DEKORATIVE BESCHLÄGE**  
**ACCESSOIRES DE DÉCORATION**  
**ACCESORIOS DECORATIVOS**





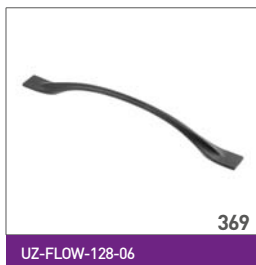







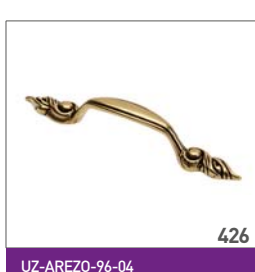





427

UZ-ADRIN-96-04



428

UZ-ACERA-96-04



428

UZ-REN096-04A



429

UZ-ROYAL1-96-10-03



430

UZ-WP1146-04



430

GZ-WP1136-04



431

GZ-WP1148-04



431

GZ-WP1152-04



432

KT-WP1147-04



432

UZ-CRA14-128



433

GZ-CRPA20-01



433

GZ-CRPB20-01



434

GZ-CRPC30-01



434

ID-GZ-CRPJ30-01



436

UM-BLOCK-ZL

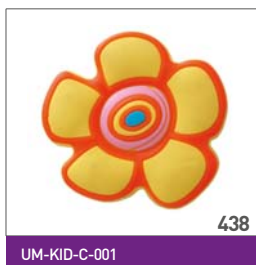
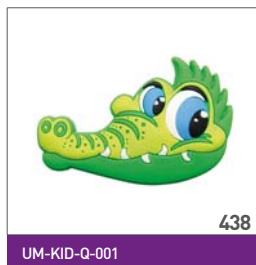



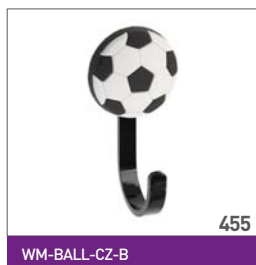

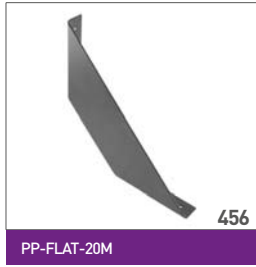





474

NM-RONDA-150-18



474

NM-MDN-D4-01



475

NM-MDN926-01



475

NM-MDN927-01



476

NM-MDN941-01



476

NM-WPJ22-D20



477

BP-SLZIGW-10



477

BP-SLZIGW-21



478

NM-STOPKA-M6



478

NM-STOPKSZESTK-M6



479

NM-MUFAWB-00



479

NM-DPD20-100



480

NM-KL-DPL-20



480

NM-DPA20-100



481

NM-KL-DPA-20









505

KM-SPAIN-40MM-18



505

KM-GREYROLL-50mm-BH

## SCIEBETÜRSYSTEME SYSTÈMES POUR PORTES COULISSANTES SISTEMAS DESLIZANTES



510

A-R18ERG-270-05



510

A-R16ERG-220-05



510

A-R18GE02-270-05



511

A-RNOV2-270-05



511

A-R18NOVS-270-05



512

A-R19NOVS-300-05



512

A-R18CARO-270-05



512

A-R18VIS-270-05



513

A-R18NERO-270-05

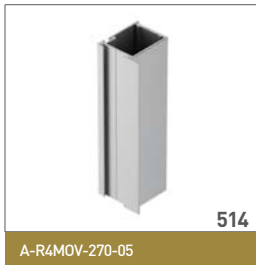









537

A-USZCZ-CHM4



537

A-USZCZ-TDEV02



537

A-B63-40



538

A-B63-32



538

A-SOFT-30



538

A-MSOFT-RAMA



538

A-SOFT-30Z



539

A-MSOFT-ADAPT



539

ZZ-SP-105-05



539

A-PW-RC-D0C



540

A-TMITO-200-00



540

A-MITO-PLUS



541

A-SN-FSET



542

A-SN-HSET1



543

A-SN-SDP-TU



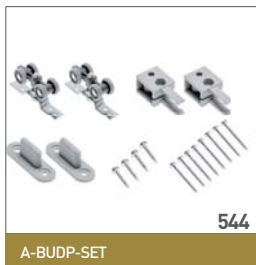

544

A-BUDP-SET



545

A-SN-LOFT-200-20MN

**MÖBELBELEUCHTUNG**  
**ÉCLAIRAGE DE MEUBLES**  
**ILUMINACIÓN DE MUEBLES**



550

LD-3528-300-20-ZB



552

LD-3528-300-20-ZB-50



552

LD-2835-24V-300-20-ZB



553

LD-ZL5RGB150-00



554

LD-COB12V-20-ZBN



554

LD-COB24V-20-ZBN



555

LD-NF-12V6x12-65-ZB



556

PA-GLAXGKL3M-00C



558

PA-GLAXGKS3M-00C











596

LD-ZAS24PRO80W-30



597

LD-ZZAS07PROKD6



598

LD-ZASPR007W-30



598

LD-ZAS150-NW



599

LD-ZAS350-NW



599

LD-WZA20W-NW



600

LD-ZASPU15W-30N



600

LD-ZSKL15-00N



601

LD-ZWND6W-10



601

LD-ZAC6WDE-RGB



602

LD-KONMINI-RGB



603

LD-KONML-MONO



603

LD-KONML-MONO-PIL



604

LD-KONML-MONO-PAN



604

LD-KONML-RGBW





614

AE-WPDRW-00



615

AE-WLPR-60



615

AE-WLB01-10



616

AE-WLIP44-15



616

LD-DIMLED-10



617

AE-WLLAN1-10



617

AE-WLSZ1-10



618

LD-KABE2M-00



618

LZ-KA2MM-10



619

LZ-KAPR2M-10



619

LZ-AKZ312-10N



620

LZ-AKZ612-10N



620

LD-ZTL82MAMP-COB



621

LD-ZTL8MM-02N600



621

LD-ZTKT8MM-02N600





640

AE-BPW3GU-20



642

AE-BPW3U60-20



643

AE-PB03GS-53



643

AE-PBU02GS-10



644

AE-PBSC3GS-53



646

AE-PBC3GS-53BKS



646

AE-PBC3GS-51BK



647

AE-PBKT4S-80





## FUNKTIONSBESCHLÄGE ACCESSOIRES FONCTIONNELS ACCESORIOS FUNCIONALES

Scharniere Charnières Bisagras	66 – 107
Türdämpfer und Druckschnäpper Amortisseurs Amortiguadores	108 – 113 / 124 – 126
Klappenbeschläge Systèmes d'ouvertures Elevadores	114 – 123
Führungen Glissières Guías	128 – 163
Schubladensysteme Systèmes de tiroirs Sistemas de cajones	166 – 216
Verbindungselemente Éléments de raccord Elementos de conexión	221 – 250
Leisten Bandes Barras	251 – 253
Befestigungen für Rohre Fixation tuyaux Fijaciones para tubos	254 – 269
Garderobenausstattung Équipement de garde-robe Equipamiento para guardarropas	270 – 293
Küchenzubehör Accessoires de cuisine Accesorios de cocina	218 – 221 / 294 – 319
Büromöbelzubehör Accessoires de bureau Accesorios para escritorio	320 – 332
Sonstige Autres Otros	333 – 337





**MB**

MODERN BOX

Richtzahl der Topfscharniere Ø35\*

\*nicht für Sonderausführungen mit weitem Öffnungswinkel

Nombre indicatif de charnières cachées Ø35\*

\*ne concerne pas les modèles spéciaux avec de grands angles d'ouverture

Cantidad orientativa de bisagras de cazoleta Ø35\*

\*no aplicable a modelos especiales de ángulo de apertura ampliado

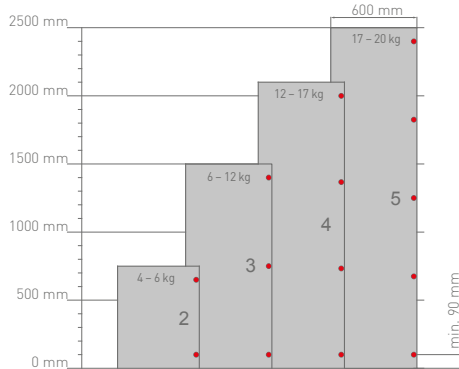

Richtzahl der Topfscharniere Ø26 und Ø35\*

\*für Sonderausführungen mit weitem Öffnungswinkel

Nombre indicatif de charnières cachées de Ø26 et de Ø35

\*ne concerne pas les modèles spéciaux avec de grand angles d'ouverture

Cantidad orientativa de bisagras de cazoleta Ø26 y Ø35\*

\*aplicable a modelos especiales de ángulo de apertura ampliado

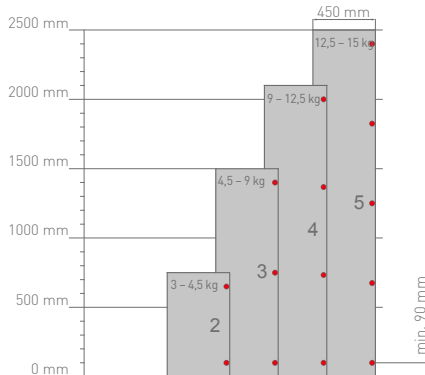

- Die Anzahl der eingesetzten Scharniere hängt von der Höhe, Breite und dem Gewicht der Frontplatte ab.
- Um die Stabilität zu gewährleisten, soll der Abstand zwischen den Scharnieren so groß wie möglich sein.
- Führen Sie vor der Serienproduktion einen Montage-test durch und überprüfen Sie die richtige Funktion.
- Le nombre de charnières utilisées dépend de la hauteur, de la largeur et du poids du panneau avant.
- Afin d'assurer la stabilité, la distance entre les charnières doit être aussi grande que possible.
- Avant la production en série, effectuer un test d'assemblage et vérifier son bon fonctionnement.
- El número de bisagras utilizadas depende de la altura, anchura y peso del frente.
- Para garantizar la estabilidad, la distancia entre las bisagras debe ser lo más grande posible.
- Antes de la producción en serie, se realiza una prueba de montaje y se comprueba que funciona correctamente.

SoftMove Mechanismus  
Mécánisme SoftMove  
Mecanismo SoftMove

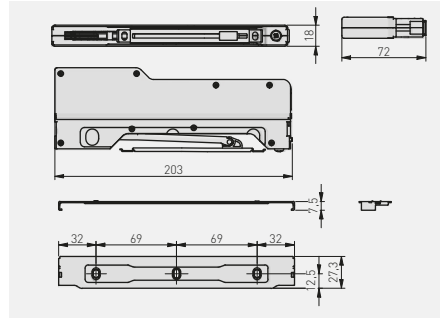

ZM-0T-STANDARD	Stahl + Kunststoff / acier + plastique / acero + plástico
ZN-0T-HEAVY*	



\*Produkt erhältlich auf individuelle Bestellung / Produit disponible sur demande / Producto disponible bajo demanda

Scharnier SilentoPro mit integrierter Dämpfung und Exzenterverstellung, Eckanschlag  
Charnière hydraulique SilentoPro, appliquée  
Bisagra hidráulica SilentoPro, con regulación excéntrica, recta

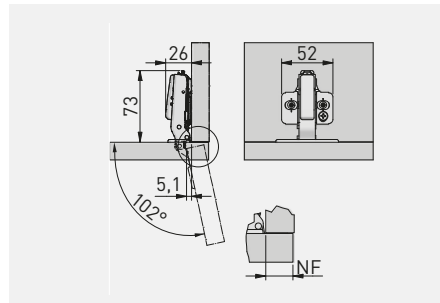

ZM-HCSL09-3D	H = 0	—	—	Nickel nickel níquel	Stahl acier acero
--------------	-------	---	---	----------------------------	-------------------------

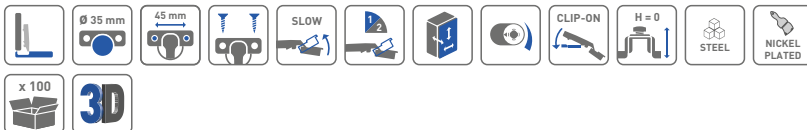

Scharnier SilentoPro mit integrierter Dämpfung und Exzenterverstellung, Mittelanschlag  
 Charnière hydraulique SilentoPro, jumelle  
 Bisagra hidráulica SilentoPro, con regulación excéntrica acodada

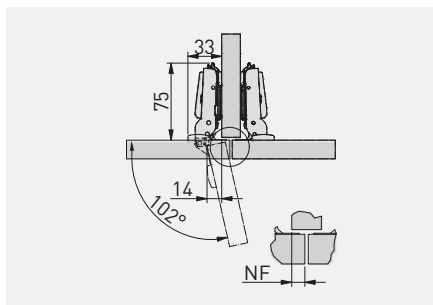

ZM-HCSL08-3D	H = 0	—	—	Nickel nickel níquel	Stahl acier acero

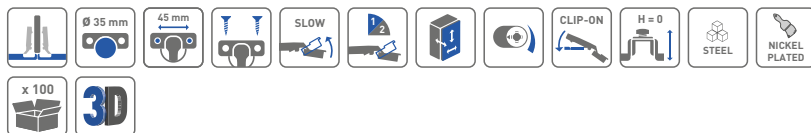

Scharnier SilentoPro mit integrierter Dämpfung und Exzenterverstellung, Innenanschlag  
 Charnière hydraulique SilentoPro, encastrée  
 Bisagra hidráulica SilentoPro, con regulación excéntrica superacodada

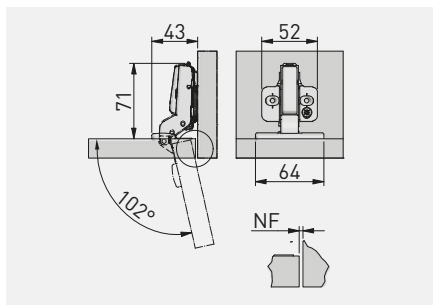

ZM-HCSL07-3D	H = 0	—	—	Nickel nickel níquel	Stahl acier acero

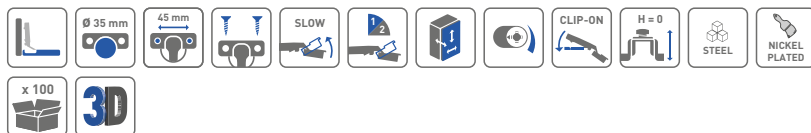

Komponenten für das Silento PRO Scharnier  
 Composants pour la charnière Silento PRO  
 Componentes de la bisagra Silento PRO



PZ-HCSL-H0-BE0  
 PZ-HCSL-H0-ZE0

Kreuzmontageplatte  
 Guide croisé  
 Guía de cruz

PZ-HCSL3D-H0-BE0

Montageplatte mit Regulierung  
 Guide avec régularisation  
 Guía con regulación

PZ-HCSL-H0-M5

Kreuzplatte + Muffen  
 Guide croisé + manchons  
 Guía de cruz + tornillos

ZM-COVERHCSL-SET

Abdeckungen - Set  
 Embout - complet  
 Tapas - juego

PZ-HCSL-H0-BE0	H = 0	—	—	x200	Nickel nickel níquel	Stahl acier acero	
PZ-HCSL-H0-ZE0		—	x2	x200			
PZ-HCSL3D-H0-BE0		—	—	x200			
PZ-HCSL-H0-M5		—	—	x200			
ZM-COVERHCSL-SET		—	—	x1000			

Scharnier SOLID plus mit integrierter Dämpfung, Eckanschlag  
 Charnière hydraulique SOLID plus, appliquée  
 Bisagra hidráulica SOLID plus, recta



ZM-DCHC09-3DBE0	H = 0	—	—	Nickel nickel níquel	Stahl acier acero	
ZM-DCHC09-3DZE0		—	x 2			



\*Produkt erhältlich auf individuelle Bestellung / Produit disponible sur demande / Producto disponible bajo demanda

Scharnier SOLID plus mit integrierter Dämpfung, Mittelanschlag  
 Charnière hydraulique SOLID plus, jumelle  
 Bisagra hidráulica SOLID plus, acodada

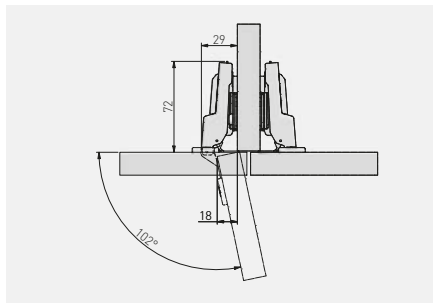

ZM-DHC08-3DBEO	H = 0	—	—	Nickel nickel niquet	Stahl acier acero
ZM-DHC08-3DZEO		—	x 2		



\*Produkt erhältlich auf individuelle Bestellung / Produit disponible sur demande / Producto disponible bajo demanda

Scharnier SOLID PLUS mit integrierter Dämpfung, Innenanschlag  
 Charnière hydraulique SOLID PLUS, encastrée  
 Bisagra hidráulica SOLID PLUS, superacodada

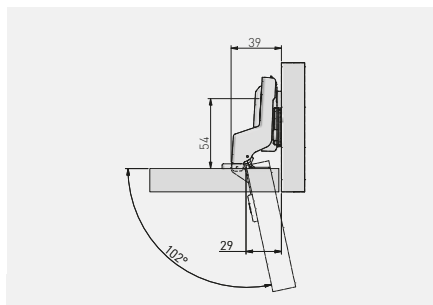

ZM-DHC07-3DBEO	H = 0	—	—	Nickel nickel niquet	Stahl acier acero
ZM-DHC07-3DZEO		—	x 2		







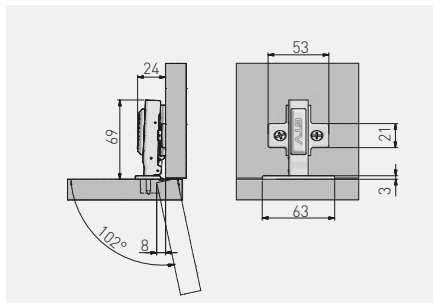

\*Produkt erhältlich auf individuelle Bestellung / Produit disponible sur demande / Producto disponible bajo demanda



Scharnier ECHC mit integrierter Dämpfung, Eckanschlag  
 Charnière hydraulique ECHC, appliquée  
 Bisagra hidráulica ECHC, recta



					
ZM-ECHC09BEO	H = 0	x 4	—	Nickel nickel níquel	Stahl acier acero
ZM-ECHC09ZEO		x 2	x 2		



\*Produkt erhältlich auf individuelle Bestellung / Produit disponible sur demande / Producto disponible bajo demanda



Scharnier ECHC mit integrierter Dämpfung, Mittelanschlag  
 Charnière hydraulique ECHC, jumelle  
 Bisagra hidráulica ECHC, acodada

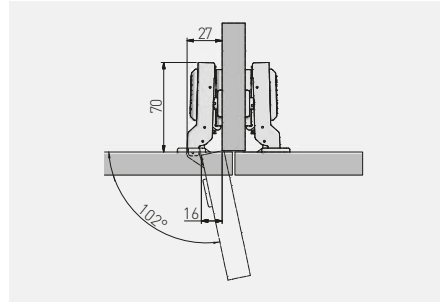

ZM-ECHC08BEO	H = 0	x 4	—	Nickel nickel níquel	Stahl acier acero
ZM-ECHC08ZEO		x 2	x 2		



\*Produkt erhältlich auf individuelle Bestellung / Produit disponible sur demande / Producto disponible bajo demanda

Scharnier ECHC mit integrierter Dämpfung, Innenanschlag  
 Charnière hydraulique ECHC, encastrée  
 Bisagra hidráulica ECHC, superacodada

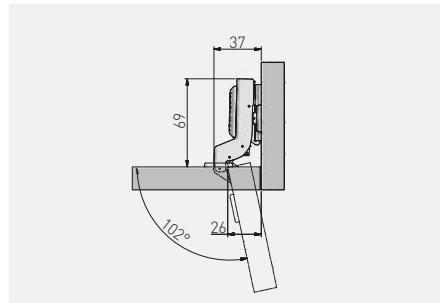

ZM-ECHC07BEO	H = 0	x 4	—	Nickel nickel níquel	Stahl acier acero
ZM-ECHC07ZEO		x 2	x 2		



\*Produkt erhältlich auf individuelle Bestellung / Produit disponible sur demande / Producto disponible bajo demanda

Scharnier ECHC mit integrierter Dämpfung, Eckanschlag  
 Charnière hydraulique ECHC, appliquée  
 Bisagra hidráulica ECHC, recta

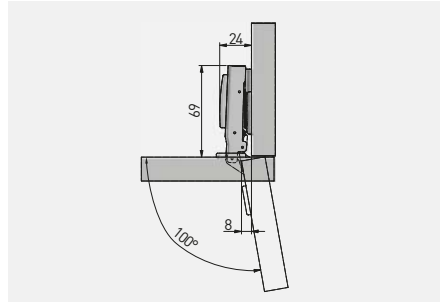

ZM-EHC09H04-BE	H = 0	x 6	—	Nickel nickel níquel	Stahl acier acero



\*Produkt erhältlich auf individuelle Bestellung / Produit disponible sur demande / Producto disponible bajo demanda

Scharnier ECHC mit integrierter Dämpfung, Mittelschlag  
 Charnière hydraulique ECHC, jumelle  
 Bisagra hidráulica ECHC, acodada

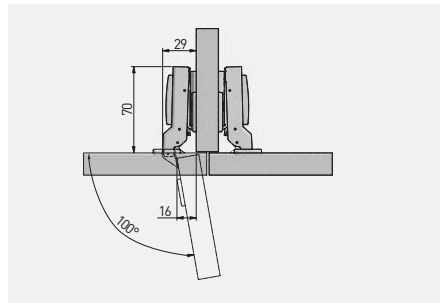

ZM-EHC08H04-BE	H = 0	x 6	—	Nickel nickel níquel	Stahl acier acero



\*Produkt erhältlich auf individuelle Bestellung / Produit disponible sur demande / Producto disponible bajo demanda

Scharnier ECHC mit integrierter Dämpfung, Innenanschlag  
 Charnière hydraulique ECHC, encastrée  
 Bisagra hidráulica ECHC, superacodada

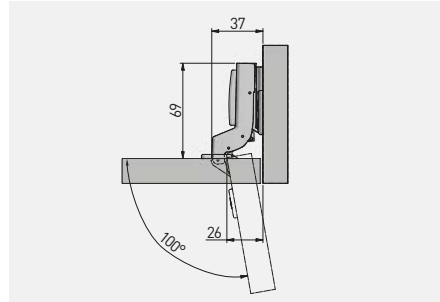

ZM-ECHC07H04-BE	H = 0	x 6	—	Nickel nickel niquel	Stahl acier acero



\*Produkt erhältlich auf individuelle Bestellung / Produit disponible sur demande / Producto disponible bajo demanda

Hydraulisches Scharnier EHC3D, Eckanschlag, mit exzenter Einstellung  
 Charnière hydraulique simple avec réglage excentrique  
 Bisagra hidráulica EHC3D recta con regulación excéntrica

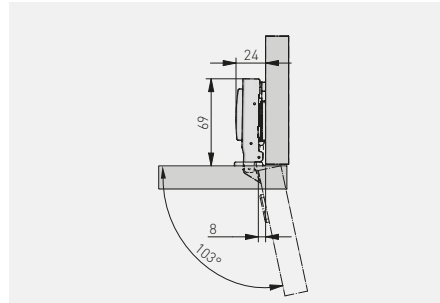

ZM-EHC09-3DBEO	H = 0	x 4	—	Nickel nickel niquel	Stahl acier acero



\*Produkt erhältlich auf individuelle Bestellung / Produit disponible sur demande / Producto disponible bajo demanda

Hydraulisches Scharnier ECHC3D, Mittelanschlag, mit exzenter Einstellung  
 Charnière hydraulique semi-encastrée avec réglage excentrique  
 Bisagra hidráulica ECHC3D acodada con regulación excéntrica

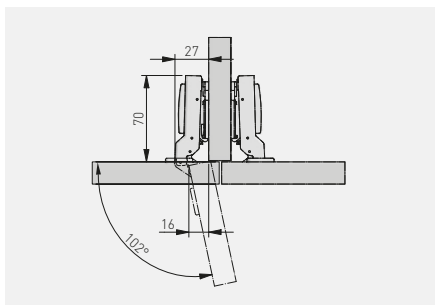

ZM-EHC08-3DBEO	H = 0	x 4	—	Nickel nickel níquel	Stahl acier acero



\*Produkt erhältlich auf individuelle Bestellung / Produit disponible sur demande / Producto disponible bajo demanda

Hydraulisches Scharnier ECHC3D, Innenanschlag, mit exzenter Einstellung  
 Charnière hydraulique encastrée avec réglage excentrique  
 Bisagra hidráulica ECHC3D superacodada con regulación excéntrica

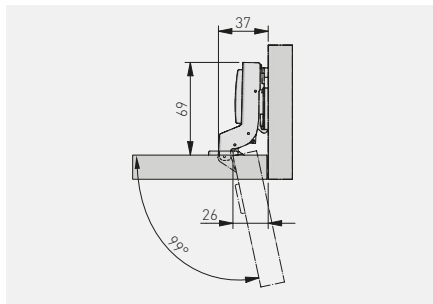

ZM-EHC07-3DBEO	H = 0	x 4	—	Nickel nickel níquel	Stahl acier acero



\*Produkt erhältlich auf individuelle Bestellung / Produit disponible sur demande / Producto disponible bajo demanda

Scharnier CNHC mit integrierter Dämpfung und Exzenterverstellung, Eckanschlag  
 Charnière hydraulique CNHC, appliquée  
 Bisagra hidráulica CNHC, con regulación excéntrica, recta

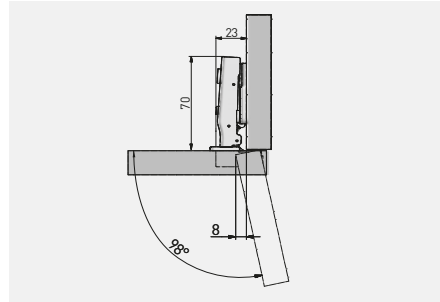

ZM-CNHC09BR2	H = 0	-	-	Nickel nickel níquel	Stahl acier acero



Scharnier CNHC mit integrierter Dämpfung und Exzenterverstellung, Mittelanschlag  
 Charnière hydraulique CNHC, jumelle  
 Bisagra hidráulica CNHC, con regulación excéntrica acodada

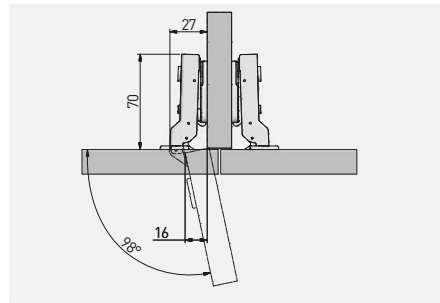

ZM-CNHC08BR2	H = 0	-	-	Nickel nickel níquel	Stahl acier acero



Scharnier CNHC mit integrierter Dämpfung und Exzenterverstellung, Innenanschlag  
 Charnière hydraulique CNHC, encastrée  
 Bisagra hidráulica CNHC, con regulación excéntrica superacodada

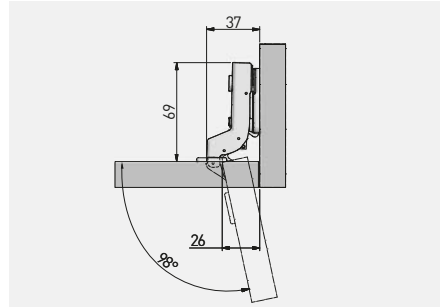

ZM-CNHC07BR2	H = 0	-	-	Nickel nickel níquel	Stahl acier acero



Scharnier INHC mit integrierter Dämpfung, Eckanschlag  
 Charnière hydraulique INHC, appliquée  
 Bisagra hidráulica INHC, recta

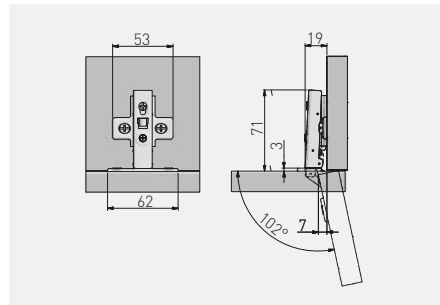

ZM-INHC090BEO	H = 0	-	-	Nickel nickel níquel	Stahl acier acero
ZM-INHC090ZEO		-	x 2		



Scharnier INHC mit integrierter Dämpfung, Mittelschlag  
 Charnière hydraulique INHC, jumelle  
 Bisagra hidráulica INHC, acodada

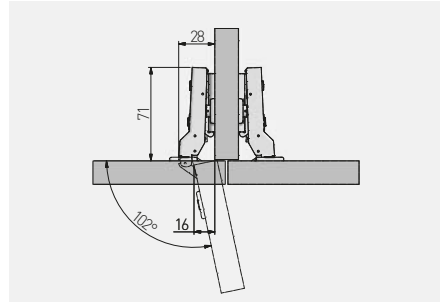

ZM-INHC080BEO	H = 0	—	—	Nickel nickel níquel	Stahl acier acero
ZM-INHC080ZEO		—	x 2		



\*Produkt erhältlich auf individuelle Bestellung / Produit disponible sur demande / Producto disponible bajo demanda

Scharnier INHC mit integrierter Dämpfung, Innenanschlag  
 Charnière hydraulique INHC, encastrée  
 Bisagra hidráulica INHC, superacodada

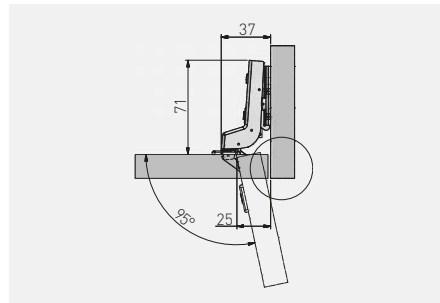

ZM-INHC070BEO	H = 0	—	—	Nickel nickel níquel	Stahl acier acero
ZM-INHC070ZEO		—	x 2		



\*Produkt erhältlich auf individuelle Bestellung / Produit disponible sur demande / Producto disponible bajo demanda



Winkelscharnier HCKT 30° mit integrierter Dämpfung  
 Charnière d'angle 30°, hydraulique HCKT  
 Bisagra 30°, hidráulica HCKT

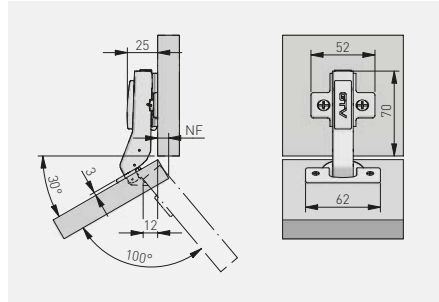

ZM-HCKT30-BE-S	H = 0	x 4	—	Nickel nickel níquel	Stahl acier acero
ZM-HCKT30-ZE-S		x 2	x 2		



\*Produkt erhältlich auf individuelle Bestellung / Produit disponible sur demande / Producto disponible bajo demanda

Winkelscharnier HCKT 45° mit integrierter Dämpfung  
 Charnière d'angle à 45° HCKT hydraulique  
 Bisagra 45°, hidráulica HCKT

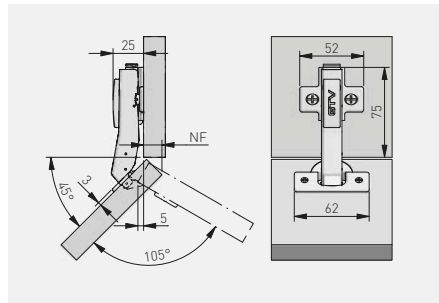

ZM-HCKT45-BE-S	H = 0	x 4	—	Nickel nickel níquel	Stahl acier acero
ZM-HCKT45-ZE-S		x 2	x 2		



\*Produkt erhältlich auf individuelle Bestellung / Produit disponible sur demande / Producto disponible bajo demanda

Winkelscharnier HCKT 45° mit integrierter Dämpfung und Exzenterverstellung  
 Charnière d'angle HCKT 45° avec réglage excentrique  
 Bisagra 45° HCKT con ajuste excéntrico

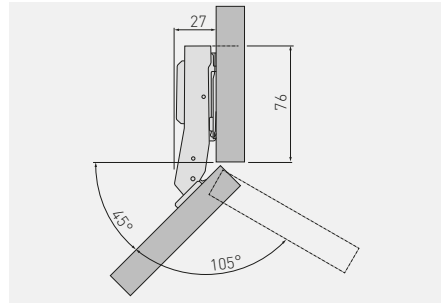

ZM-HCKT45-3DBE0-S	H = 0	x 4	—	Nickel nickel níquel	Stahl acier acero



\*Produkt erhältlich auf individuelle Bestellung / Produit disponible sur demande / Producto disponible bajo demanda

Winkelscharnier HCKT mit integrierter Dämpfung, Stollenanschlag  
 Charnière hydraulique parallèle HCKT  
 Bisagra 90° hidráulica HCKT

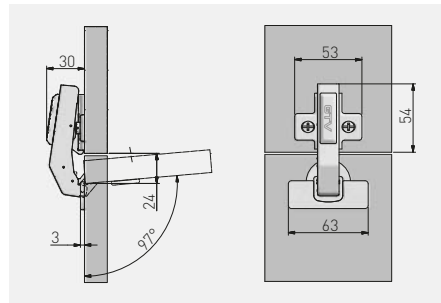

ZM-HCKT90-BE-S	H = 0	x 4	—	Nickel nickel níquel	Stahl acier acero
ZM-HCKT90-ZE-S		x 2	x 2		



\*Produkt erhältlich auf individuelle Bestellung / Produit disponible sur demande / Producto disponible bajo demanda

Winkelscharnier HCKT mit integrierter Dämpfung und Exzenterverstellung, Stollenanschlag  
 Charnière parallèle HCKT avec réglage excentrique  
 Bisagra 90° HCKT con ajuste excéntrico

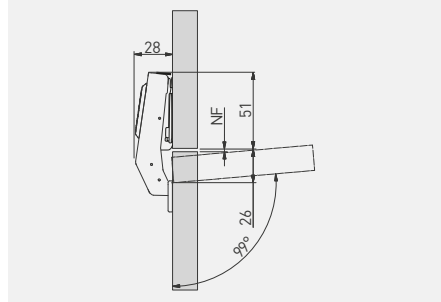

ZM-HCKT90-3DBE0-S	H = 0	x 4	—	Nickel nickel níquel	Stahl acier acero



\*Produkt erhältlich auf individuelle Bestellung / Produit disponible sur demande / Producto disponible bajo demanda

Parallelscharnier - kurzer Arm mit Spannfeder KT  
 Charnière parallèle - bras court avec ressort de tension KT  
 Bisagra acodada - brazo corto con muelle de tensión KT

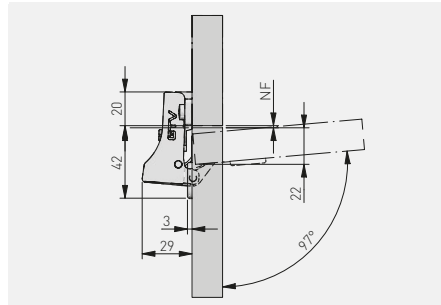

ZM-HCKTK90-ZE	H = 0	x 2	—	Nickel nickel níquel	Stahl acier acero



Winkelscharnier HCKT 155° mit integrierter Dämpfung, für Schubladenschränke  
 Charnière hydraulique 155° HCKT  
 Bisagra 155° hidráulica con regulación excéntrica HCKT

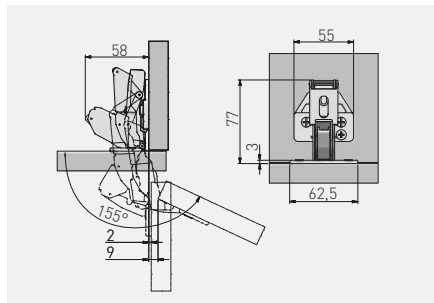

ZM-HCKT155BE	H = 0	—	—	Nickel nickel níquel	Stahl acier acero	
ZM-HCKT155ZE		—	x 2			



\*Produkt erhältlich auf individuelle Bestellung / Produit disponible sur demande / Producto disponible bajo demanda

Winkelscharnier HCKT 165° mit integrierter Dämpfung  
 Charnière hydraulique 165° HCKT  
 Bisagra 165° hidráulica HCKT

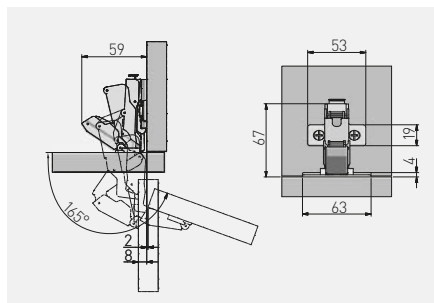

ZM-HCKT165BE-S	H = 0	—	—	Nickel nickel níquel	Stahl acier acero	
ZM-HCKT165ZE-S		—	x 2			



\*Produkt erhältlich auf individuelle Bestellung / Produit disponible sur demande / Producto disponible bajo demanda

Winkelscharnier HCKT 165° mit integrierter Dämpfung und Exzenterverstellung  
 Charnière hydraulique 165° HCKT avec réglage excentrique  
 Bisagra 165° hidráulica HCKT con ajuste excéntrico

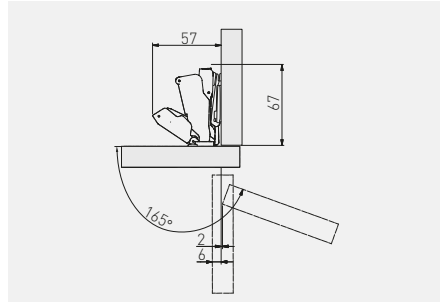

ZM-HCKT165-3DBE0-S	H = 0	—	—	Nickel nickel níquel	Stahl acier acero



\*Produkt erhältlich auf individuelle Bestellung / Produit disponible sur demande / Producto disponible bajo demanda

Scharnier SOLID, Eckanschlag  
 Charnière SOLID, appliquée  
 Bisagra SOLID, recta

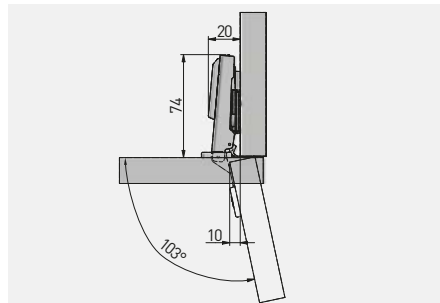

ZP-BIDI09-3DBE0	H = 0	—	—	Nickel nickel níquel	Stahl acier acero



\*Produkt erhältlich auf individuelle Bestellung / Produit disponible sur demande / Producto disponible bajo demanda

Scharnier SOLID, Mittelschlag  
 Charnière SOLID, jumelle  
 Bisagra SOLID, superacodada

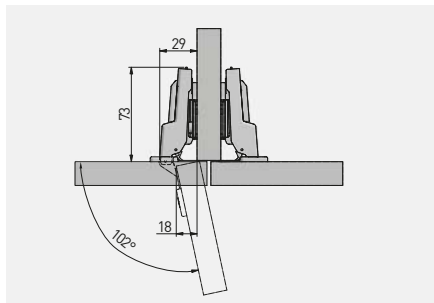

ZP-BIDI08-3DBEO	H = 0	—	—	Nickel nickel níquel	Stahl acier acero



\*Produkt erhältlich auf individuelle Bestellung / Produit disponible sur demande / Producto disponible bajo demanda

Scharnier SOLID, Innenanschlag  
 Charnière SOLID, encastrée  
 Bisagra SOLID, superacodada

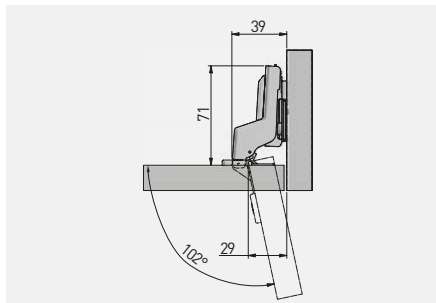

ZP-BIDI07-3DBEO	H = 0	—	—	Nickel nickel níquel	Stahl acier acero



\*Produkt erhältlich auf individuelle Bestellung / Produit disponible sur demande / Producto disponible bajo demanda

Scharnier CONL, Eckanschlag  
 Charnière CONL, appliquée  
 Bisagra CONL, recta

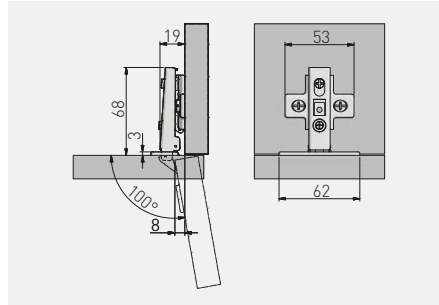

ZP-CONL09-BE	H = 0	—	—	Nickel nickel níquel	Stahl acier acero	
ZP-CONL09-ZE		—	x 2			



\*Produkt erhältlich auf individuelle Bestellung / Produit disponible sur demande / Producto disponible bajo demanda

Scharnier CONL, Mittelanschlag  
 Charnière CONL, jumelle  
 Bisagra CONL, acodada

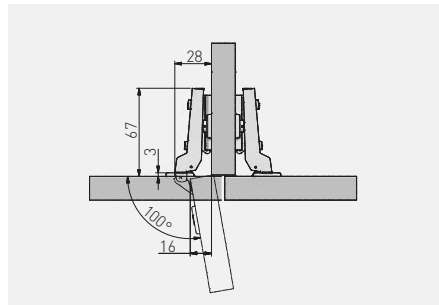

ZP-CONL08-BE	H = 0	—	—	Nickel nickel níquel	Stahl acier acero	
ZP-CONL08-ZE		—	x 2			



\*Produkt erhältlich auf individuelle Bestellung / Produit disponible sur demande / Producto disponible bajo demanda

Scharnier CONL, Innenanschlag  
 Charnière CONL, encastrée  
 Bisagra CONL, superacodada

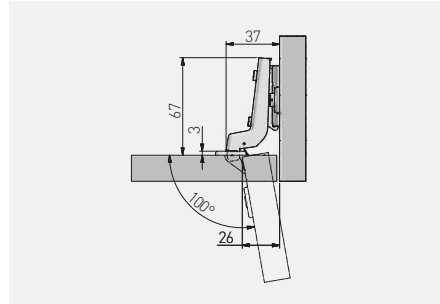

ZP-CONL07-BE	H = 0	—	—	Nickel nickel níquel	Stahl acier acero
ZP-CONL07-ZE		—	x 2		



\*Produkt erhältlich auf individuelle Bestellung / Produit disponible sur demande / Producto disponible bajo demanda

Scharnier BICN, Eckanschlag  
 Charnière BICN, appliquée  
 Bisagra BICN, recta

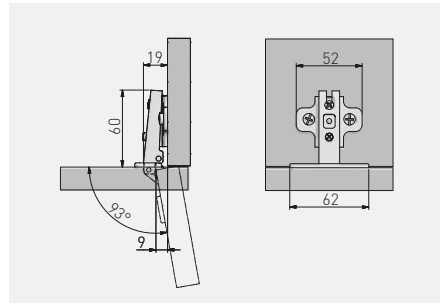

ZP-BICN090BE	H = 0	—	—	Nickel nickel níquel	Stahl acier acero
ZP-BICN090ZE		—	x 2		
ZP-BICN092BE	H = 2	—	—	Nickel nickel níquel	Stahl acier acero
ZP-BICN092ZE		—	x 2		



\*Produkt erhältlich auf individuelle Bestellung / Produit disponible sur demande / Producto disponible bajo demanda



Scharnier BICN, Mittelschlag  
 Charnière BICN, jumelle  
 Bisagra BICN, superacodada

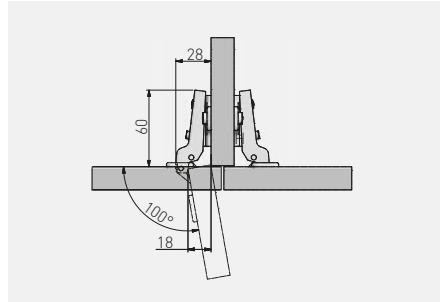

ZP-BICN080BE	H = 0	—	—	Nickel nickel níquel	Stahl acier acero
ZP-BICN080ZE		—	x 2		
ZP-BICN082BE	H = 2	—	—		
ZP-BICN082ZE		—	x 2		



\*Produkt erhältlich auf individuelle Bestellung / Produit disponible sur demande / Producto disponible bajo demanda

Scharnier BICN, Innenanschlag  
 Charnière BICN, encastrée  
 Bisagra BICN, superacodada

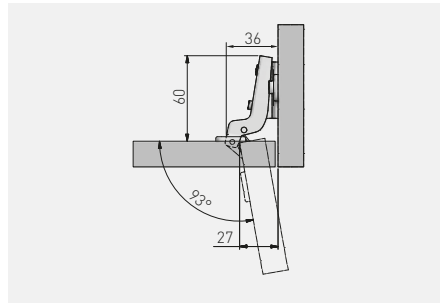

ZP-BICN070BE	H = 0	—	—	Nickel nickel níquel	Stahl acier acero
ZP-BICN070ZE		—	x 2		
ZP-BICN072BE	H = 2	—	—		
ZP-BICN072ZE		—	x 2		



\*Produkt erhältlich auf individuelle Bestellung / Produit disponible sur demande / Producto disponible bajo demanda

Scharnier BICJ-B, Eckanschlag  
 Charnière BICJ-B, appliquée  
 Bisagra BICJ-B, recta

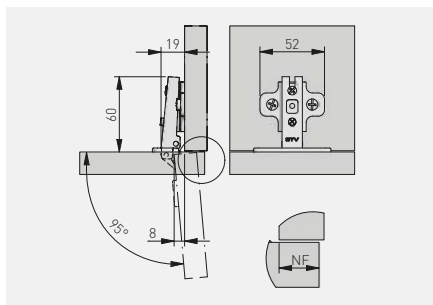

ZP-BICJ290ZE-B	H = 0	—	x 2	Nickel nickel níquel	Stahl acier acero
ZP-BICJ090ZE-B	H = 2	—	x 2		



Scharnier BICJ-B, Mittelschlag  
 Charnière BICJ-B, jumelle  
 Bisagra BICJ-B, supercodada

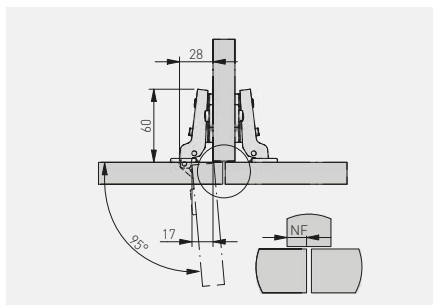

ZP-BICJ080ZE-B	H = 0	—	x 2	Nickel nickel níquel	Stahl acier acero
ZP-BICJ280ZE-B	H = 2	—	x 2		



Scharnier BICJ-B, Innenanschlag  
 Charnière BICJ-B, encastrée  
 Bisagra BICJ-B, superacodada

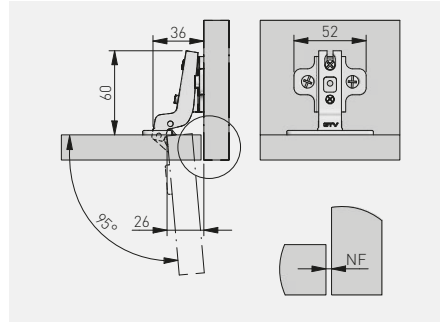

ZP-BICJ070ZE-B	H = 0	—	x 2	Nickel nickel níquel	Stahl acier acero
ZP-BICJ270ZE-B	H = 2	—	x 2		



Öffnungswinkelbegrenzung für das Scharnier  
 Limiteur d'angle d'ouverture pour la charnière  
 Tope del ángulo de apertura de la bisagra

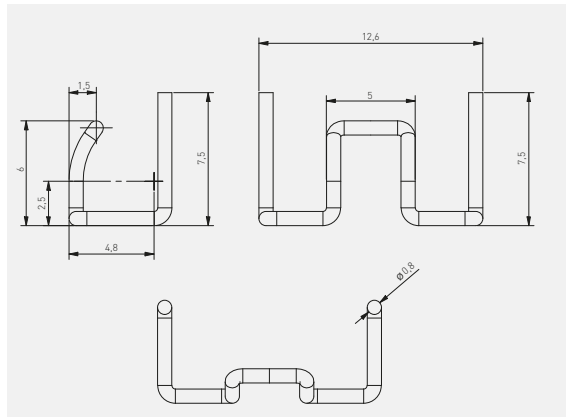
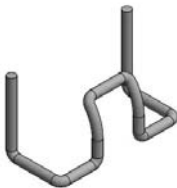

Z-ÖGR-KAT	Stahl acier acero

Winkelscharnier KT 30°  
 Charnière d'angle 30° KT  
 Bisagra 30° KT

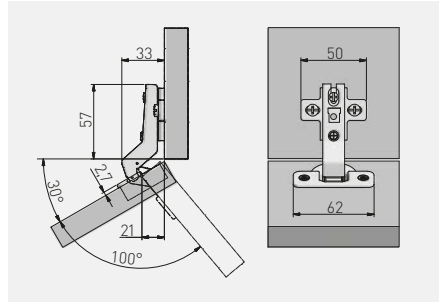

ZP-KT30H2-BE	H = 2	—	—	Nickel nickel níquel	Stahl acier acero



Winkelscharnier KT 45°  
 Charnière d'angle 45° KT  
 Bisagra 45° KT

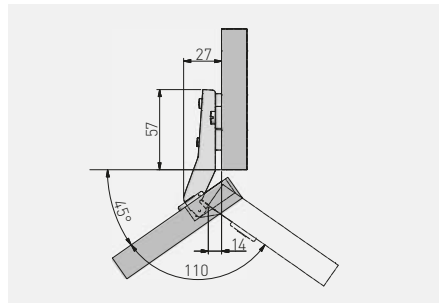

ZP-KT45H2-BE	H = 2	—	—	Nickel nickel níquel	Stahl acier acero
ZP-KT45H2-ZE		—	x 2		



Scharnier KT, Stollenanschlag  
 Charnière parallèle KT  
 Bisagra 90° KT

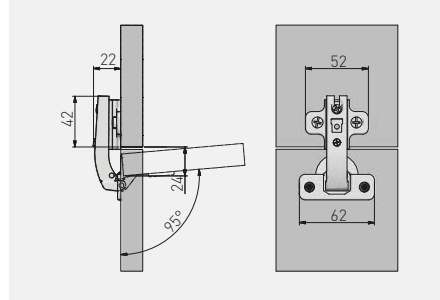

ZP-KT90H2-BE	H = 2	—	—	Nickel nickel níquel	Stahl acier acero
ZP-KT90H2-ZE		—	x 2		



Scharnier KTK, Stollenanschlag, mit kurzem Arm  
 Charnière parallèle - bras court KTK  
 Bisagra 90° - recta KTK

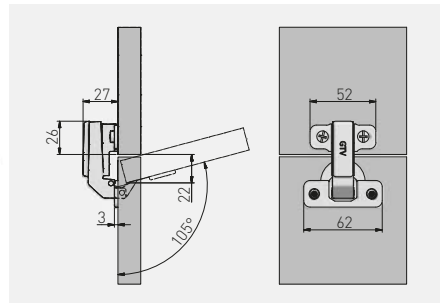

ZP-KTK90H6BE	H = 6	—	—	Nickel nickel níquel	Stahl acier acero
ZP-KTK90H6ZE		—	x 2		



Winkelscharnier KT 165°  
 Charnière 165° KT  
 Bisagra 165° KT

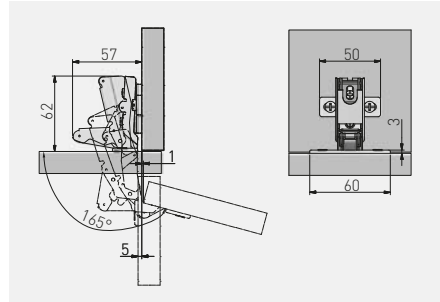

ZP-KT165H2BE	H = 2	—	—	Nickel nickel níquel	Stahl acier acero
ZP-KT165H2ZE		—	x 2		



Winkelscharnier KT 135°  
 Charnière 135° KT  
 Bisagra 135° KT

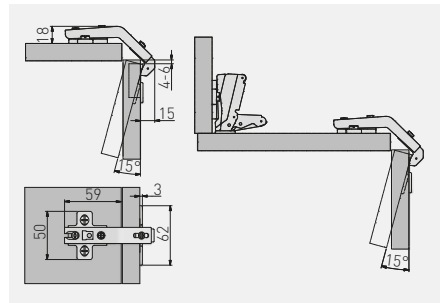

ZP-KT135H2BE	H = 2	—	—	Nickel nickel níquel	Stahl acier acero
ZP-KT135H2ZE		—	x 2		



Scharnier COCA ohne Feder, Eckanschlag  
 Charnière sans ressort COCA, appliquée  
 Bisagra sin muelle COCA, recta

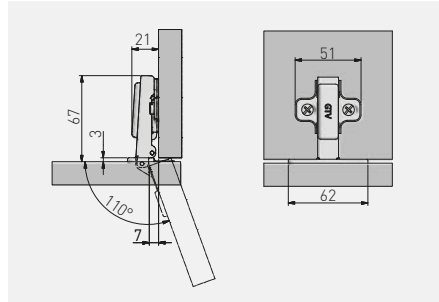

ZP-COCA450-BE	H = 0	—	—	Nickel nickel níquel	Stahl acier acero
ZP-COCA450-ZE		—	x 2		



Scharnier COCA ohne Feder, Innenanschlag  
 Charnière sans ressort COCA, encastrée  
 Bisagra sin muelle COCA, superacodada

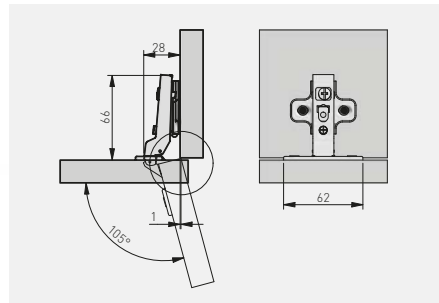

ZP-COCAB450-BE	H = 0	—	—	Nickel nickel níquel	Stahl acier acero



Scharnier COCA ohne Feder, Innenanschlag  
 Charnière sans ressort COCA, encastrée  
 Bisagra sin muelle COCA, superacodada

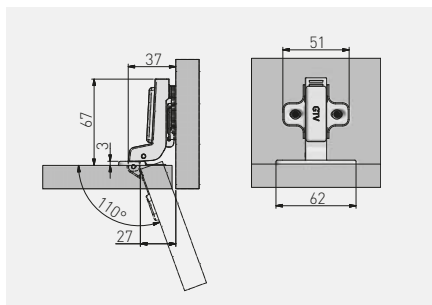

ZP-COCA7450-BE	H = 0	—	—	Nickel nickel níquel	Stahl acier acero



Scharnier COCA ohne Feder, Eckanschlag  
 Charnière sans ressort COCA, appliquée  
 Bisagra sin muelle COCA, recta

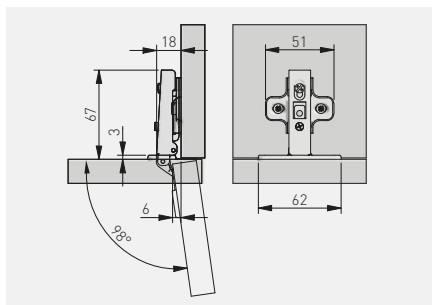

ZP-COCA450-BE-F	H = 0	—	—	Nickel nickel níquel	Stahl acier acero





Scharnier COCA ohne Feder, Innenanschlag  
 Charnière sans ressort COCA, encastrée  
 Bisagra sin muelle COCA, superacodada

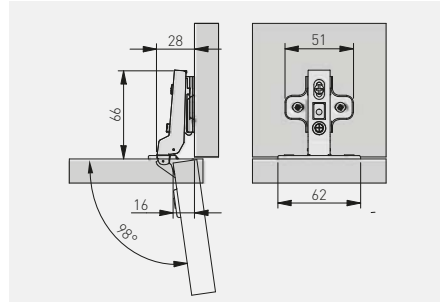

ZP-COCA8450-BE-F	H = 0	—	—	Nickel nickel níquel	Stahl acier acero



Scharnier COCA ohne Feder, Innenanschlag  
 Charnière sans ressort COCA, encastrée  
 Bisagra sin muelle COCA, superacodada

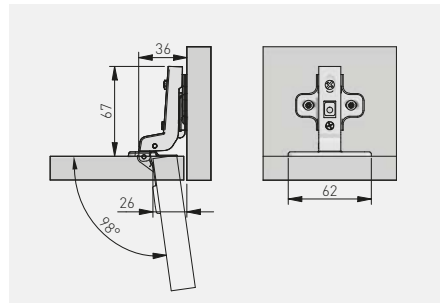

ZP-COCA7450-BE-F	H = 0	—	—	Nickel nickel níquel	Stahl acier acero



Scharnier P0, selbstöffnend, Eckanschlag  
 Charnière automatique P0, appliquée  
 Bisagra slide on P0, de recta

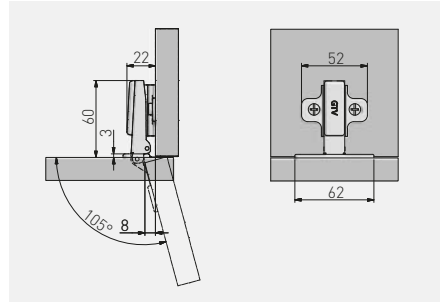

ZP-POH045BE0	H = 0	—	—	Nickel nickel níquel	Stahl acier acero
ZP-POH045ZE0		—	x 2		



Scharnier P0, selbstöffnend, Innenanschlag  
 Charnière automatique P0, encastrée  
 Bisagra autoapertura P0, superacodada

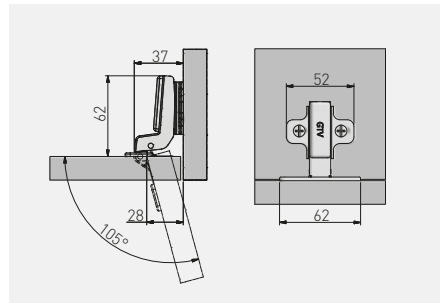

ZP-P07H045BE	H = 0	—	—	Nickel nickel níquel	Stahl acier acero



Minischarnier CIHC mit integrierter Dämpfung, Eckanschlag  
 Charnière hydraulique mini CIHC, appliquée  
 Bisagra hidráulica mini CIHC, recta

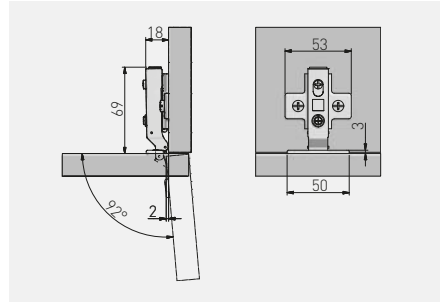

ZP-CIHC090ZE	H = 0	x 2	x 2	Nickel nickel níquel	Stahl + ZnAl, acier + ZnAl, acero + ZnAl,



Minischarnier CIHC mit integrierter Dämpfung, Mittelanschlag  
 Charnière hydraulique mini CIHC, jumelle  
 Bisagra hidráulica mini CIHC, acodada

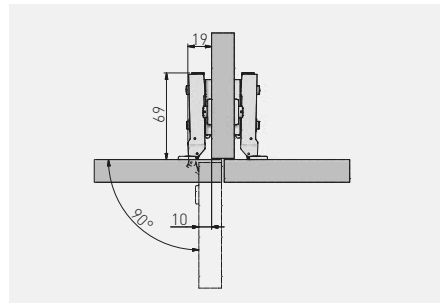

ZP-CIHC080ZE	H = 0	x 2	x 2	Nickel nickel níquel	Stahl + ZnAl, acier + ZnAl, acero + ZnAl,



Minischarnier CIHC mit integrierter Dämpfung, Innenanschlag  
 Charnière hydraulique mini CIHC, encastrée  
 Bisagra hidráulica mini CIHC, superacodada

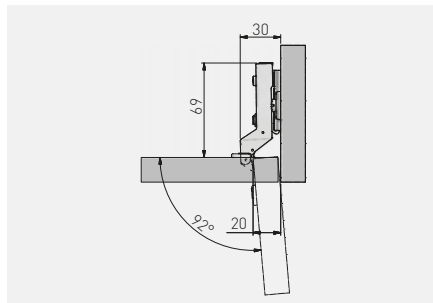

ZP-CIHC070ZE	H = 0	x 2	x 2	Nickel nickel niquel	Stahl + ZnAl, acier + ZnAl, acero + ZnAl,



Minischarnier CIBI, Eckanschlag  
 Charnière mini CIBI, appliquée  
 Bisagra mini CIBI, recta

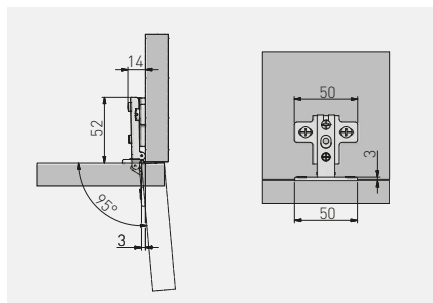

ZP-CIBI9H0ZE	H = 0	-	x 2	Nickel nickel niquel	Stahl acier acero



Minischarnier CIBI, Mittelanschlag  
 Charnière mini CIBI, jumelle  
 Bisagra mini CIBI, acodada

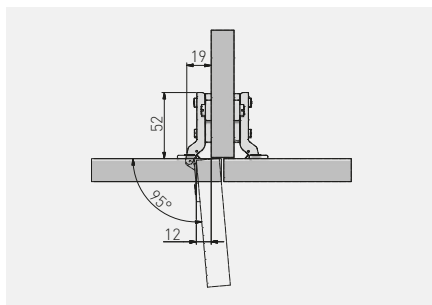

ZP-CIBI8H0ZE	H = 0	-	x 2	Nickel nickel níquel	Stahl acier acero



Minischarnier CIBI, Innenanschlag  
 Charnière mini CIBI, encastrée  
 Bisagra mini CIBI, superacodada

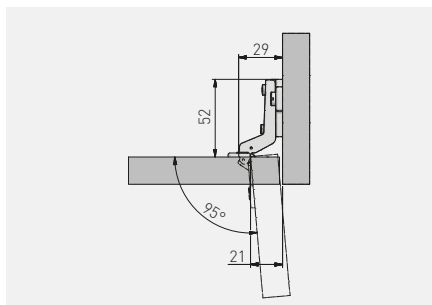

ZP-CIBI7H0ZE	H = 0	-	x 2	Nickel nickel níquel	Stahl acier acero



Glastürscharnier CIG, Eckenschlag  
 Charnière CIG pour verre, appliquée  
 Bisagra para cristal CIG, recta

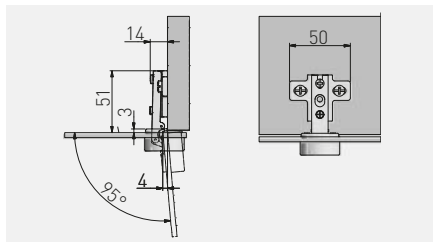

ZP-CIG-090ZE	H = 0	—	x 2	Nickel nickel níquel	Stahl + Kunststoff, acier + plastique, acero + plástico,		Chrom, chrome, cromado	
ZP-CIG-090ZE		—	x 2					
ZP-CIG-090UBE		—	—				schwarz / noir / negro	
ZP-CIG-090ZC		—	x 2					
ZP-CIG-190ZE		—	x 2				Aluminium / aluminium / aluminio	
ZP-CIG-190ZE		—	x 2					



Glastürscharnier CIG, Innenanschlag  
 Charnière CIG pour verre, encastrée  
 Bisagra para cristal CIG, superacodada

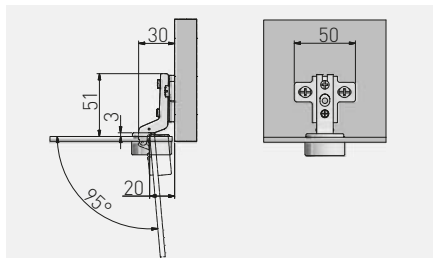

ZP-CIG-070ZE	H = 0	—	x 2	Nickel nickel níquel	Stahl + Kunststoff, acier + plastique, acero + plástico,		Chrom, chrome, cromado	
ZP-CIG-070ZE		—	x 2					
ZP-CIG-170ZE		—	x 2				Aluminium, aluminium, aluminio	
ZP-CIG-170ZE		—	x 2					



Scharnier für Aluminiumrahmen, Eckanschlag  
 Charnière pour cadres en aluminium, appliquée  
 Bisagra para marcos de aluminio, recta

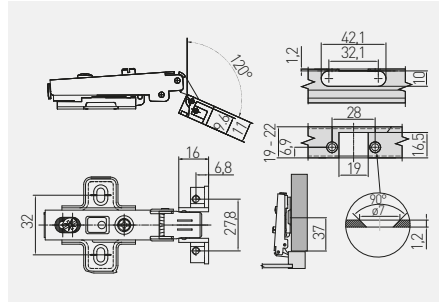

Kompatibles Produkt: Aluprofil für Frontplatten PA-3731-35-50  
 Produit compatible: profilé d'aluminium pour les façades PA-3731-35-50 0  
 Producto compatible: perfil de aluminio para frentes PA-3731-35-50

ZP-RALUH2-00	H = 2	—	—	Nickel nickel níquel	Stahl acier acero



Scharnier mit integrierter Dämpfung für Aluminiumrahmen, Eckanschlag  
 Charnière pour cadre en aluminium, encastrée  
 Bisagra hidráulica de marcos de aluminio, recta

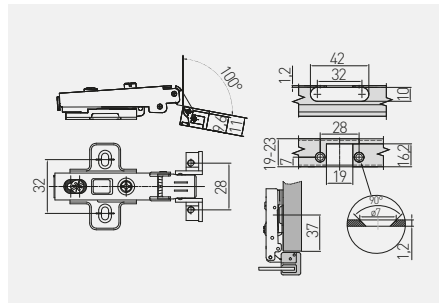

Kompatibles Produkt: Aluprofil für Frontplatten PA-3731-35-50  
 Produit compatible: profilé d'aluminium pour les façades PA-3731-35-50 0  
 Producto compatible: perfil de aluminio para frentes PA-3731-35-50

ZM-HCRALU9BE	H = 0	—	—	Nickel nickel níquel	Stahl acier acero



Winkelscharnier 270°, Eckanschlag  
 Charnière 270°, appliquée  
 Bisagra de 270°, recta

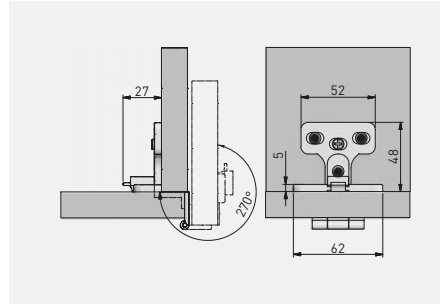

ZP-KT0270-BE	—	—	Nickel nickel níquel	ZnAl



Aufschraubcharnier groß  
 Charnière à ressort  
 Bisagra de pistón grande

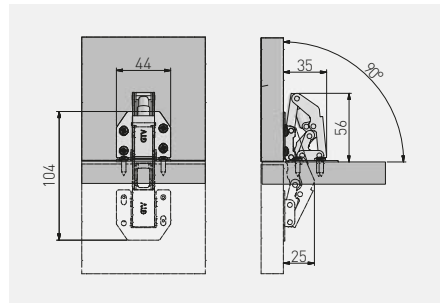

ZT-HF-01-D00	—	—	Nickel nickel níquel	Stahl acier acero





Aufschraubcharnier klein  
 Charnière à ressort  
 Bisagra de pistón pequeña

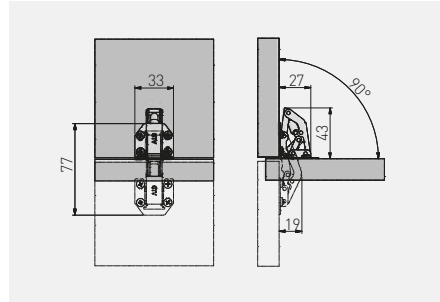

ZT-HF-01-M00	—	—	Nickel nickel níquel	Stahl acier acero



Scharnier JUNIOR 75°  
 Charnière JUNIOR 75°  
 Bisagra JUNIOR 75°

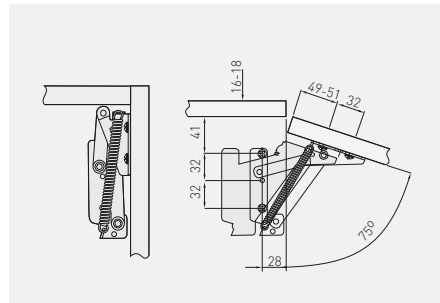

ZP-JUNIOR-00	—	—	Nickel nickel níquel	Stahl acier acero



Falttürscharnier  
Charnière aile  
Bisagra de ala

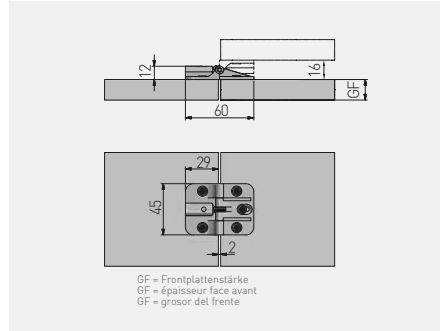

ZP-SKR-00-80	-	-	lackiert peinture barnizado	grau gris, gris	ZnAl



Zylinderscharnier  
Charnière cylindrique  
Bisagra cilíndrica

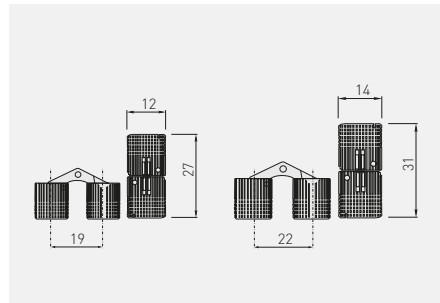

ZC-GTV-12-00	1 Set = 2 Stk. 1 ensemble = 2 pc. 1 jgo. = 2 uds.	12	7	Messing, laiton, latón,	Messing, laiton, latón,
ZC-GTV-14-00		14			



Klappenscharnier  
Charnière d'abattant  
Bisagra de brazo

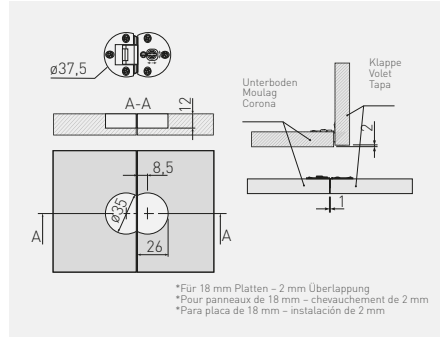

PD-MD-ZB-01-KPL	1 Set = 2 Stk. 1 ensemble = 2 pc	Chrom / chrome / cromado	ZnAl
PD-MD-ZB-04-KPL	1 jgo. = 2 uds.	Altmessing / laiton ancien / latón envejecido	



Bohrschablone für Scharniere  
Gabarit de perçage pour les charnières  
Plantilla de perforación para bisagras

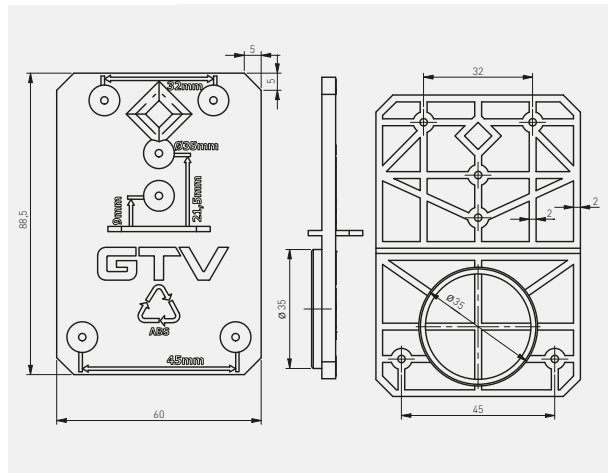

ZM-SZABLON-ZAW	Kunststoff / plastique / plástico
----------------	-----------------------------------

Türdämpfer mit Kreuzmontageplatte  
 Amortisseur avec adaptateur transversal  
 Impulsor con adaptador en cruz

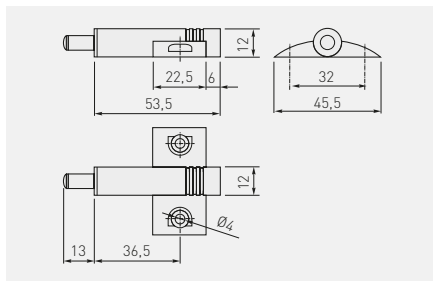

AM-KRZYZ-KPL



grau  
gris,  
gris



Kunststoff  
plastique  
plástico



Türdämpfer AM-ODB  
 Amortisseur AM-ODB  
 Impulsor AM-ODB

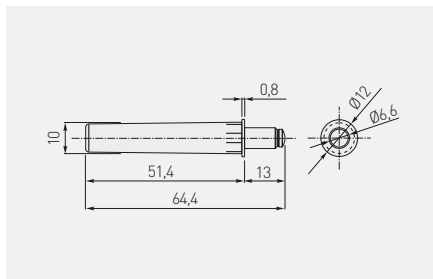

AM-ODB000-60



standard



grau / gris / gris

weiß / blanc / blanco



Kunststoff / plastique / plástico



Gerade Montageplatte für Türdämpfer AM-ODB  
 Support d'amortisseur AM-ODB droit  
 Adaptador AM-ODB recto

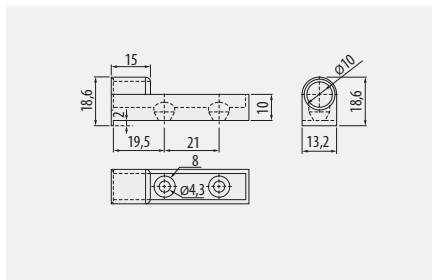

AM-ADAP0B-60	grau / gris / gris	Kunststoff / plastique / plástico
AM-ADAP0B-10	weiß / blanc / blanco	



Kreuzmontageplatte für Türdämpfer AM-ODB  
 Support d'amortisseur transversal AM-ODB  
 Adaptador AM-ODB en cruz

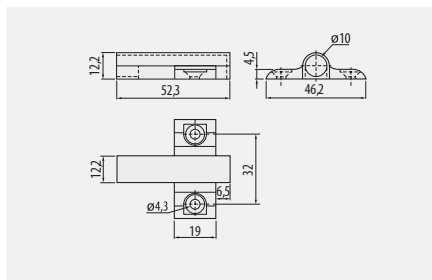

AM-ADAP0A-60	grau / gris / gris	Kunststoff / plastique / plástico
AM-ADAP0A-10	weiß / blanc / blanco	



Druckschnäpper SALTO, zum Einbohren, kurz  
Amortisseur SALTO encastré court  
Impulsor SALTO empotrable corto

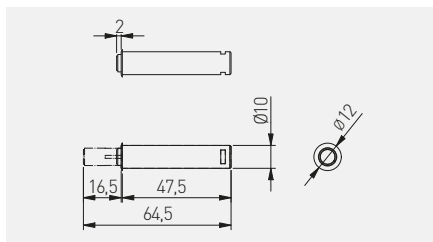

AM-OWM-KR-MG-10	mit Magnetspitze / avec extrémité magnétique / con punta magnética	weiß / blanc / blanco	min. 3,5	Kunststoff plástico plástico
AM-OWM-KR-GM-10	mit Kautschukspitze / avec embout en caoutchouc / con punta de caucho			
AM-OWM-KR-MG-30	mit Magnetspitze / avec extrémité magnétique / con punta magnética	grau / gris / gris		
AM-OWM-KR-GM-30	mit Kautschukspitze / avec embout en caoutchouc / con punta de caucho			
AM-OWM-KR-MG-60	mit Magnetspitze / avec extrémité magnétique / con punta magnética	anthrazit / anthracite / antracita		
AM-OWM-KR-GM-60	mit Kautschukspitze / avec embout en caoutchouc / con punta de caucho			



Druckschnäpper SALTO, zum Einbohren, lang  
Amortisseur SALTO encastré long  
Impulsor SALTO empotrable largo

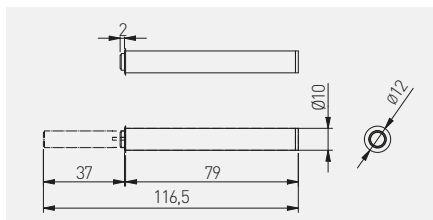

AM-OWM-DL-MG-10	mit Magnetspitze / avec extrémité magnétique / con punta magnética	weiß / blanc / blanco	min. 3,5	Kunststoff plástico plástico
AM-OWM-DL-GM-10	mit Kautschukspitze / avec embout en caoutchouc / con punta de caucho			
AM-OWM-DL-MG-30	mit Magnetspitze / avec extrémité magnétique / con punta magnética	grau / gris / gris		
AM-OWM-DL-GM-30	mit Kautschukspitze / avec embout en caoutchouc / con punta de caucho			
AM-OWM-DL-MG-60	mit Magnetspitze / avec extrémité magnétique / con punta magnética	anthrazit / anthracite / antracita		
AM-OWM-DL-GM-60	mit Kautschukspitze / avec embout en caoutchouc / con punta de caucho			



Druckschnäpper AM-PL mit Montageplatte  
Amortisseur avec adaptateur AM-PL  
Tope AM-PL con adaptador

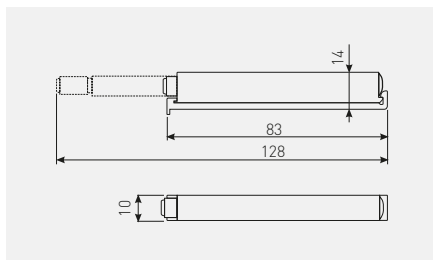

AM-PL-DL-MAG	mit Magnetspitze / avec extrémité magnétique / con punta magnética	grau gris, gris	min. 2,5	Kunststoff plastique plástico
AM-PLA-DLU-0	mit Kautschukspitze / avec embout en caoutchouc / con punta de caucho		min. 4,5	



ATürdämpfer AM-PL mit Adapter  
Butée AM-PL avec adaptateur  
Amortiguador AM-PL con adaptador

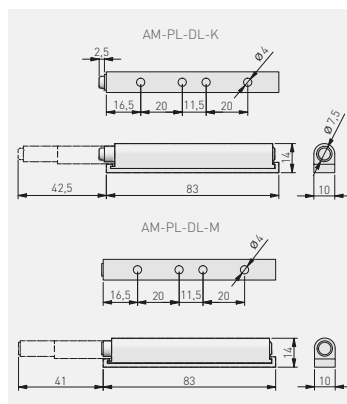

AM-PL-DL-M	mit Magnetspitze / avec extrémité magnétique / con punta magnética	grau gris, gris	min. 2,5	Kunststoff plastique plástico
AM-PL-DL-K	mit Kautschukspitze / avec embout en caoutchouc / con punta de caucho		min. 3,5	



Druckschnäpper SALTO, kurz mit Adapter  
Amortisseur SALTO court avec adaptateur  
Impulsor SALTO corto con adaptador

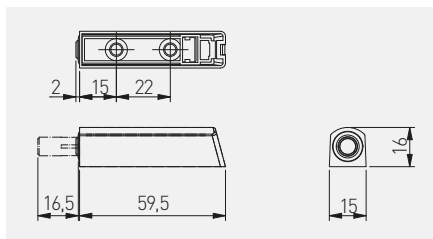

AM-OAM-KR-MG-10	mit Magnetspitze / avec extrémité magnétique / con punta magnética	weiß blanc blanco	min. 2,5	Kunststoff plastique plástico
AM-OAM-KR-GM-10	mit Kautschukspitze / avec embout en caoutchouc / con punta de caucho			
AM-OAM-KR-MG-30	mit Magnetspitze / avec extrémité magnétique / con punta magnética	grau gris, gris		
AM-OAM-KR-GM-30	mit Kautschukspitze / avec embout en caoutchouc / con punta de caucho			
AM-OAM-KR-MG-60	mit Magnetspitze / avec extrémité magnétique / con punta magnética	anthrazit / anthracite / antracita		
AM-OAM-KR-GM-60	mit Kautschukspitze / avec embout en caoutchouc / con punta de caucho			



Druckschnäpper SALTO, lang mit Adapter  
Amortisseur SALTO long avec adaptateur  
Impulsor SALTO largo con adaptador

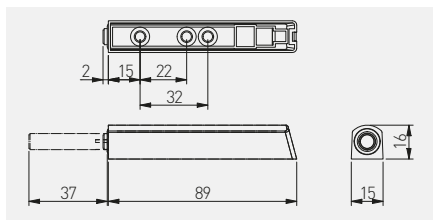

AM-OAM-DL-MG-10	mit Magnetspitze / avec extrémité magnétique / con punta magnética	weiß / blanc / blanco	min. 3,5	Kunststoff plastique plástico
AM-OAM-DL-GM-10	mit Kautschukspitze / avec embout en caoutchouc / con punta de caucho			
AM-OAM-DL-MG-30	mit Magnetspitze / avec extrémité magnétique / con punta magnética	grau / gris / gris		
AM-OAM-DL-GM-30	mit Kautschukspitze / avec embout en caoutchouc / con punta de caucho			
AM-OAM-DL-MG-60	mit Magnetspitze / avec extrémité magnétique / con punta magnética	anthrazit / anthracite / antracita		
AM-OAM-DL-GM-60	mit Kautschukspitze / avec embout en caoutchouc / con punta de caucho			





## Druckschnäpper AM-ZAT Loquet a poussoir AM-ZAT Tope AM-ZAT a presión

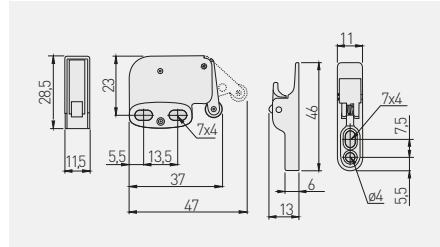

AM-ZAT-A1-10

weiß  
blanc  
blancoStahl + Kunststoff,  
acier + plastique,  
acero + plástico,Zum Einsatz mit selbstöffnendem Scharnier  
ZP-POH045ZE0Pour utilisation avec charnière à ouverture  
automatique ZP-POH045ZE0Para usar con bisagra de apertura automática  
ZP-POH045ZE0

x 500



## Silikon-Anschlagpuffer Amortisseur en silicone Topes de silicona



AMR-BP-1003



Ø10 x 3



100 Stück / Blatt, 100 pc / feuille, 100 uds. / hoja

AMR-BP-0715

Ø7 x 1,5

x 100



## Klappenbeschlag PD-LIFTNEW Dispositif d'ouverture PD-LIFTNEW Elevador PD-LIFTNEW

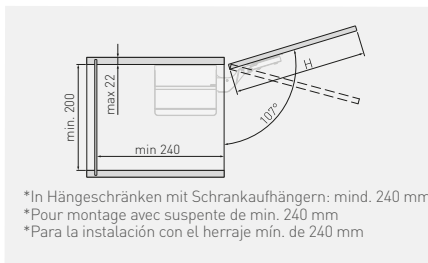

Höhe der Frontplatte  
Hauteur face avant indicative  
Altura del frente aproximada

F-Faktor  
Coefficient de res-  
sort F  
Factor F

Feder  
Ressort  
Muelle



	Höhe der Frontplatte Hauteur face avant indicative Altura del frente aproximada	F-Faktor Coefficient de res- sort F Factor F	Feder Ressort Muelle	Material	
PD-LIFTNEW-LIGHT-10	250 - 400 mm	480 - 1250	light	weiß / blanc / blanco	Stahl acier acero
PD-LIFTNEW-LIGHT-80				grau / gris / gris	
PD-LIFTNEW-MEDIUM-10	250 - 500 mm	960 - 2350	medium	weiß / blanc / blanco	
PD-LIFTNEW-MEDIUM-80				grau / gris / gris	
PD-LIFTNEW-STRONG-10	250 - 500 mm	1600 - 3600	strong	weiß / blanc / blanco	
PD-LIFTNEW-STRONG-80				grau / gris / gris	
PD-LIFTNEW-STRONG-PLUS-10	600 mm	2500 - 4500	extra strong	weiß / blanc / blanco	
PD-LIFTNEW-STRONG-PLUS-80				grau / gris / gris	

Kraftfaktor F = Fronten­höhe H (mm) x Frontengewicht samt doppeltem Griffgewicht (kg)

Facteur de puissance F = hauteur face avant H (mm) x poids avant, y compris le double poids de la poignée (kg)

Factor de potencia F = altura del frente H (mm) x peso del frente con peso doble del tirador (kg)

## Klappenbeschlag PD-LIFT-P20 Dispositif d'ouverture PD-LIFT-P20 Elevador PD-LIFT-P20

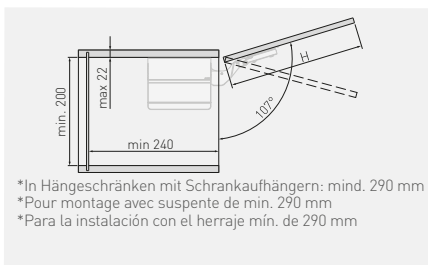

Höhe der Frontplatte  
Hauteur face avant indicative  
Altura del frente aproximada

F-Faktor  
Coefficient de ressort F  
Factor F

Feder  
Ressort  
Muelle



	Höhe der Frontplatte Hauteur face avant indicative Altura del frente aproximada	F-Faktor Coefficient de ressort F Factor F	Feder Ressort Muelle	Material	
PD-LIFT-P20-LIGHT-10	250 - 400 mm	580 - 1350	light	weiß / blanc / blanco	Stahl acier acero
PD-LIFT-P20-LIGHT-80				grau / gris / gris	
PD-LIFT-P20-MEDIUM-10	250 - 500 mm	1060 - 2450	medium	weiß / blanc / blanco	
PD-LIFT-P20-MEDIUM-80				grau / gris / gris	
PD-LIFT-P20-STRONG-10	250 - 500 mm	1800 - 4000	strong	weiß / blanc / blanco	
PD-LIFT-P20-STRONG-80				grau / gris / gris	
PD-LIFT-P20-STRONG-PLUS-10	600 mm	2600 - 5000	extra strong	weiß / blanc / blanco	
PD-LIFT-P20-STRONG-PLUS-80				grau / gris / gris	

Kraftfaktor F = Fronten­höhe H (mm) x Frontengewicht samt doppeltem Griffgewicht (kg)



Facteur de puissance F = hauteur face avant H (mm) x poids avant, y compris le double poids de la poignée (kg)

Factor de potencia F = altura del frente H (mm) x peso del frente con peso doble del tirador (kg)

Klappenbeschlag PD-MINILIFTNEW  
 Dispositif d'ouverture PD-MINILIFTNEW  
 Elevador PD-MINILIFTNEW

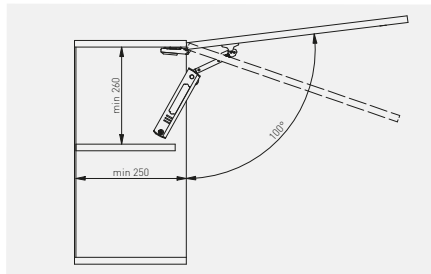
NEW



	Frontmaße Dimensions de la façade Dimensiones de frente		Frontgewicht Poids de la façade Peso de frente	Empfohlene Anzahl der Klappenbe- schläge (Stk.) Nombre recom- mandé d'élévateurs (pcs.) Número recomen- dado de elevadores (unidades)		
	Höhe Hauteur Altura	Breite Largeur Anchura				
PD-MINILIFTNEW-LIGHT	300-400 mm	500-800 mm	2-3 kg	1	Chrom / chrome / cromado	Stahl acier acero
PD-MINILIFTNEW-LIGHT-20	300-400 mm	500-1000 mm	3,1-4 kg	2	schwarz / noir / negro	
PD-MINILIFTNEW-MEDIUM	300-450 mm	500-1000 mm	3,5-4,5 kg	1	Chrom / chrome / cromado	
PD-MINILIFTNEW-MEDIUM-20	300-450 mm	500-1200 mm	5,5-7,5 kg	2	schwarz / noir / negro	
PD-MINILIFTNEW-STRONG	380-550 mm	500-1200 mm	5-6 kg	1	Chrom / chrome / cromado	
PD-MINILIFTNEW-STRONG-20	380-550 mm	500-1200 mm	6,5-10 kg	2	schwarz / noir / negro	



Gasdruckfeder mit integriertem Dämpfer, verstellbar  
 Vérin à gaz avec amortisseur, réglable  
 Elevador de gas con amortiguador y regulación

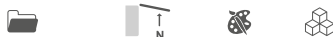
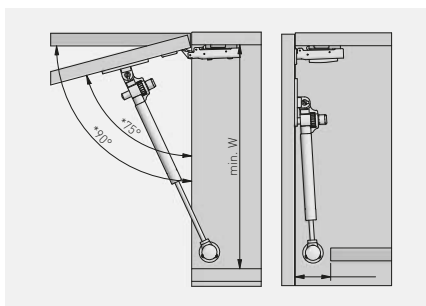

PD-GAM050-N02	50 N	grau gris gris	Stahl acier acero
PD-GAM060-N02	60 N		
PD-GAM080-N02	80 N		
PD-GAM100-N02	100 N		
PD-GAM120-N02	120 N		
PD-GAM150-N02	150 N	weiß blanc blanco	
PD-GAM050-N10	50 N		
PD-GAM060-N10	60 N		
PD-GAM080-N10	80 N		
PD-GAM100-N10	100 N		
PD-GAM120-N10	120 N	anthrazit anthracite antracita	
PD-GAM150-N10	150 N		
PD-GAM050-N60	50 N		
PD-GAM060-N60	60 N		
PD-GAM080-N60	80 N		
PD-GAM100-N60	100 N		
PD-GAM120-N60	120 N		
PD-GAM150-N60	150 N		

Türöffnungswinkel, Angle d'ouverture de la porte, Ángulo de apertura de la puerta,	H (mm)	L (mm)	W (mm)
75°	295	64	315
90°	275	52	300



Türöffnungswinkel, Angle d'ouverture de la porte, Ángulo de apertura de la puerta,	Kraft der Gasdruckfeder, Puissance de levage, Potencia del elevador,	Türhöhe (mm) / Hauteur de porte (mm) / Altura de la puerta (mm) /			
		300	400	500	600
		Türgewicht (kg) / Poids de la porte (kg) / Peso de la puerta (kg)			
<p>75°</p>	50 N	1,6	1,2	1,0	0,8
	60 N	2,0	1,5	1,2	1,0
	80 N	2,7	2,0	1,6	1,4
	100 N	3,4	2,6	2,0	1,7
	120 N	4,1	3,1	2,5	2,0
<p>90°</p>	50 N	1,5	1,1	0,9	0,7
	60 N	1,8	1,3	1,1	0,9
	80 N	2,4	1,8	1,4	1,2
	100 N	3,0	2,2	1,8	1,5
	120 N	3,6	2,7	2,1	1,8
	150 N	4,1	3,2	2,3	2,1



## Gasdruckfeder Standard Vérin à gaz standard Elevador de gas estándar



PD-G0050-N02	50 N	grau gris gris	Stahl acier acero
PD-G0060-N02	60 N		
PD-G0080-N02	80 N		
PD-G0100-N02	100 N		
PD-G0120-N02	120 N		
PD-G0150-N02	150 N		

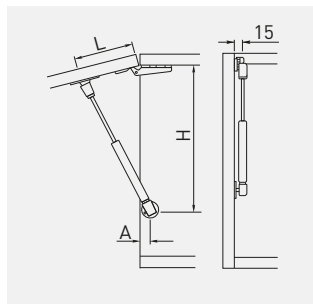

Türöffnungswinkel, Angle d'ouverture de la porte, Ángulo de apertura de la puerta,	Innenliegende Tür, Porte encastrée, Puerta empotrada,			Halb-aufschlagende Tür, Porte double, Puerta doble,			Aufschlagende Tür, Porte appliquée, Puerta de superficie,		
	H (mm)	L (mm)	A (mm)	H (mm)	L (mm)	A (mm)	H (mm)	L (mm)	A (mm)
75°	280	100	20 + Frontplattenstärke, 20 + épaisseur du panneau avant, 20 + grosor del frente,	272	100	25	264	100	25
90°	260	90		251	90	25	244	90	25
100°	250	80		242	80	25	234	80	25

Türöffnungswinkel, Angle d'ouverture de la porte, Ángulo de apertura de la puerta,	Kraft der Gasdruckfeder, Puissance de levage, Potencia del elevador,	Türhöhe (mm) / Hauteur de porte (mm) / Altura de la puerta (mm) /			
		300	400	500	600
		Türgewicht (kg) / Poids de la porte (kg) / Peso de la puerta (kg)			
 75°	60 N	2,0	1,5	1,2	1,0
	80 N	2,7	2,0	1,6	1,4
	100 N	3,4	2,6	2,0	1,7
	120 N	4,1	3,1	2,5	2,0
	150 N	4,7	3,5	2,9	2,4
 90°	60 N	1,8	1,3	1,1	0,9
	80 N	2,4	1,8	1,4	1,2
	100 N	3,0	2,2	1,8	1,5
	120 N	3,6	2,7	2,1	1,8
	150 N	4,1	3,2	2,3	2,1
 100°	60 N	1,6	1,2	0,9	0,8
	80 N	2,1	1,6	1,2	1,0
	100 N	2,6	1,9	1,6	1,3
	120 N	3,1	2,3	1,9	1,6
	150 N	3,5	2,6	2,2	1,9

## Gasdruckfeder Standard Vérin à gaz standard Elevador de gas estándar



PD-G0050-N03	50 N	grau gris gris	Stahl acier acero
PD-G0060-N03	60 N		
PD-G0080-N03	80 N		
PD-G0100-N03	100 N		
PD-G0120-N03	120 N		
PD-G0150-N03	150 N		

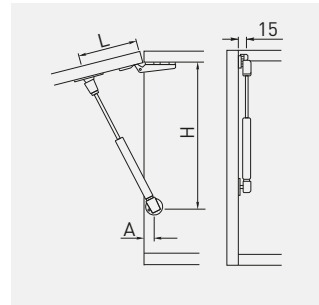

Türöffnungswinkel, Angle d'ouverture de la porte, Ángulo de apertura de la puerta,	Aufschlagende Tür, Porte appliquée, Puerta de superficie,		
	H (mm)	L (mm)	A (mm)
75°	280	72	12
90°	237	60	
100°	228	52	

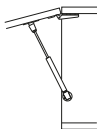
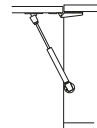
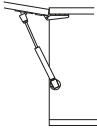
Türöffnungswinkel, Angle d'ouverture de la porte, Ángulo de apertura de la puerta,	Kraft der Gasdruckfeder, Puissance de levage, Potencia del elevador,	Türhöhe (mm) / Hauteur de porte (mm) / Altura de la puerta (mm) /			
		300	400	500	600
Türgewicht (kg) / Poids de la porte (kg) / Peso de la puerta (kg)					
75° 	50 N	1,6	1,2	1,0	0,8
	60 N	2,0	1,5	1,2	1,0
	80 N	2,7	2,0	1,6	1,4
	100 N	3,4	2,6	2,0	1,7
	120 N	4,1	3,1	2,5	2,0
	150 N	4,7	3,5	2,9	2,4
90° 	50 N	1,5	1,1	0,9	0,7
	60 N	1,8	1,3	1,1	0,9
	80 N	2,4	1,8	1,4	1,2
	100 N	3,0	2,2	1,8	1,5
	120 N	3,6	2,7	2,1	1,8
	150 N	4,1	3,2	2,3	2,1
100° 	50 N	1,1	1,0	0,8	0,7
	60 N	1,6	1,2	0,9	0,8
	80 N	2,1	1,6	1,2	1,0
	100 N	2,6	1,9	1,6	1,3
	120 N	3,1	2,3	1,9	1,6
	150 N	3,5	2,6	2,2	1,9

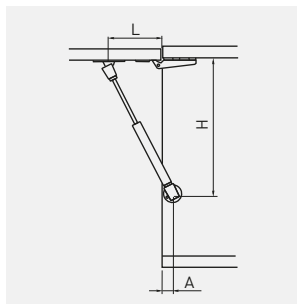

Gasdruckfeder kurz  
Vérin court à gaz  
Elevador de gas corto



PD-G60160-02	60 N	grau gris gris	Stahl acier acero
PD-G80160-02	80 N		



Türöffnungswinkel, Angle d'ouverture de la porte, Ángulo de apertura de la puerta,	Innenliegende Tür, Porte encastrée, Puerta empotrada,			Halb-aufschlagende Tür, Porte double, Puerta doble,			Aufschlagende Tür, Porte appliquée, Puerta de superficie,		
	H (mm)	L (mm)	A (mm)	H (mm)	L (mm)	A (mm)	H (mm)	L (mm)	A (mm)
75°	188	70	20 + Frontplattenstärke, 20 + épaisseur du panneau avant, 20 + grosor del frente.	180	70	20	172	70	20
90°	176	60		167	60	20	160	60	20
100°	172	50		164	50	20	154	50	20

Türöffnungswinkel, Angle d'ouverture de la porte, Ángulo de apertura de la puerta,	Kraft der Gasdruckfeder, Puissance de levage, Potencia del elevador	Türhöhe (mm) / Hauteur de porte (mm) / Altura de la puerta (mm) /			
		300	400	500	600
		Türgewicht (kg) / Poids de la porte (kg) / Peso de la puerta (kg)			
75° 	60 N	2,0	1,5	1,2	1,0
	80 N	2,7	2,0	1,6	1,4
90° 	60 N	1,8	1,3	1,1	0,9
	80 N	2,4	1,8	1,4	1,2
100° 	60 N	1,6	1,2	0,9	0,8
	80 N	2,1	1,6	1,2	1,0



Mechanische Klappenstütze DESIGN  
 Compas mécanique DESIGN  
 Elevador DESIGN mecánico



PD-GPD01-001	Chrom / chrome / cromado	Stahl acier acero
PD-GPD02-002	Nickel matt / satiné / satinado	
PD-GPD03-005	Aluminium / aluminium / aluminio	



Klappenstütze  
 Dispositif d'ouverture de volets  
 Elevador para tapas



100°

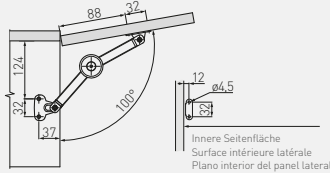

Richtwertediagramm des maximalen Gewichts in Abhängigkeit von der Höhe der Klappe.  
 Diagramme des valeurs approximatives des poids maximums en fonction de la hauteur du volet.  
 Diagrama de valores aproximados del peso máximo en función de la altura de la tapa.

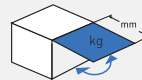

Klappenstütze  
 Dispositif d'ouverture de volets  
 Elevador para tapas



75°

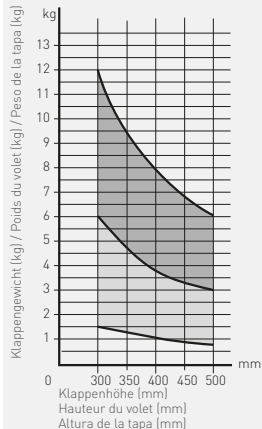
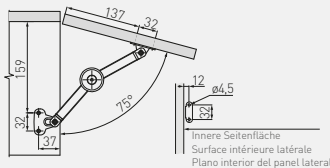

Klappenstütze  
 Dispositif d'ouverture de volets  
 Elevador para tapas



90°

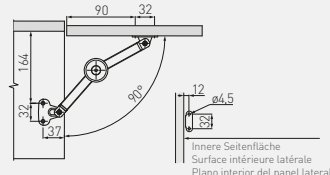

Klappenstütze. Visualisierung für Klappenschärniere  
 Séparation pour volets Visualisation de la charnière de lépaule  
 Extensión para tapas Visualización de la bisagra de brazo



90°

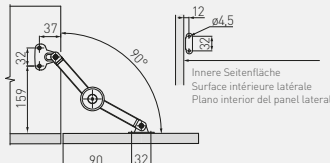

- 1 Klappenstütze  
1 dispositif d'ouverture  
1 elevador
- 2 Klappenstütze  
2 dispositif d'ouverture  
2 elevadores

Mechanische Klappenstütze Standard  
 Compas mécanique standard  
 Elevador mecánico estándar



		
PD-PD000-001	Chrom / chrome / cromado	Stahl / acier / acero



Klappenstütze  
 Dispositif d'ouverture de volets  
 Elevador para tapas



100°

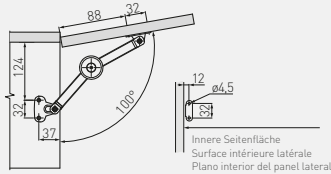

Klappenstütze  
 Dispositif d'ouverture de volets  
 Elevador para tapas



75°

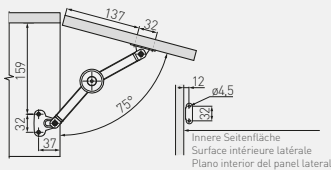

Klappenstütze  
 Dispositif d'ouverture de volets  
 Elevador para tapas



90°

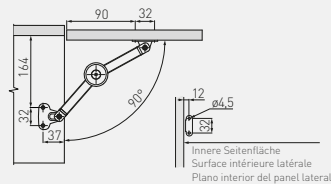

Klappenstütze. Visualisierung für Klappenscharniere  
 Séparation pour volets Visualisation de la charnière de l'épaule  
 Extensión para tapas Visualización de la bisagra de brazo



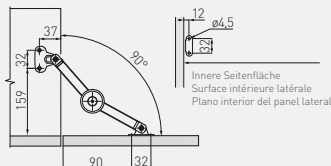

90°

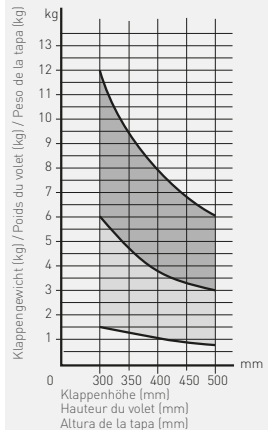
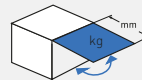

Richtwertediagramm des maximalen Gewichts in Abhängigkeit von der Höhe der Klappe.  
 Diagramme des valeurs approximatives des poids maximums en fonction de la hauteur du volet.  
 Diagrama de valores aproximados del peso máximo en función de la altura de la tapa.



-  1 Klappenstütze  
1 dispositif d'ouverture  
1 elevador
-  2 Klappenstütze  
2 dispositif d'ouverture  
2 elevadores

Mechanische Klappenstütze Standard  
 Compas mécanique standard  
 Elevador mecánico estándar



		
PD-PD000-001B	Chrom / chrome / cromado	Stahl / acier / acero



Klappenstütze  
 Dispositif d'ouverture de volets  
 Elevador para tapas

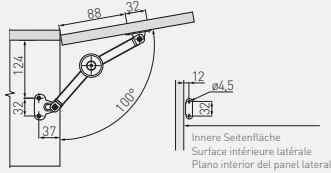

Klappenstütze  
 Dispositif d'ouverture de volets  
 Elevador para tapas

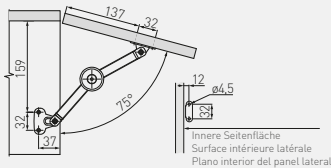

Klappenstütze  
 Dispositif d'ouverture de volets  
 Elevador para tapas

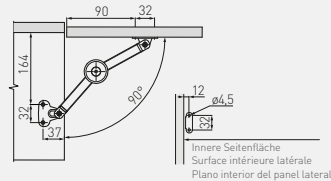

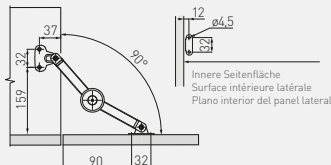
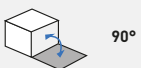

Klappenstütze. Visualisierung für Klappenscharniere  
 Séparation pour volets Visualisation de la charnière de l'épaule  
 Extensión para tapas Visualización de la bisagra de brazo

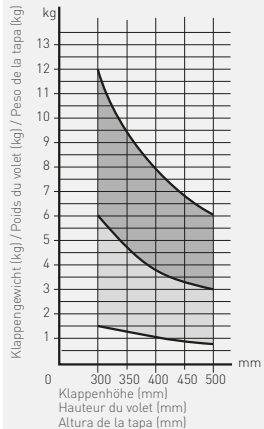
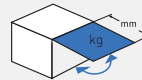

Richtwertediagramm des maximalen Gewichts in Abhängigkeit von der Höhe der Klappe.  
 Diagramme des valeurs approximatives des poids maximums en fonction de la hauteur du volet.  
 Diagrama de valores aproximados del peso máximo en función de la altura de la tapa.



-  1 Klappenstütze  
1 dispositif d'ouverture  
1 elevador
-  2 Klappenstütze  
2 dispositif d'ouverture  
2 elevadores

Dämpfer für Klappen VIM, kurz  
 Vérin VIM pour porte abattante, court  
 Amortiguador VIM para puertas de mueble-bar brazo, corto



Produkt kompatibel mit Klappenscharnier PD-MD-ZB  
 Produit compatible avec charnière d'abattant PD-MD-ZB  
 Producto compatible con bisagra de brazo PD-MD-ZB

		
PD-MDLIFT-P1-D	grau / gris / gris	Stahl acier acero



Richtwerttabelle für die Wahl der Anzahl der Dämpfer in Abhängigkeit von der Klappenbreite und -höhe.  
 Tableau indicatif des valeurs de sélection de dispositifs d'ouverture, en fonction de la largeur et de la hauteur du volet.  
 Tabla indicativa de los valores de selección de elevadores en función de la anchura y la altura de la tapa.

Höhe Hauteur Altura	Breite / Largeur / Anchura			
	600 mm	700 mm	800 mm	900 mm
Anzahl der Dämpfer / Nombre d'amortisseurs / Número de amortiguadores				
250 mm	1	1	2	2
260 mm				
270 mm				
280 mm				
290 mm				
300 mm	2	2	2	
310 mm				
320 mm				
330 mm				
340 mm				

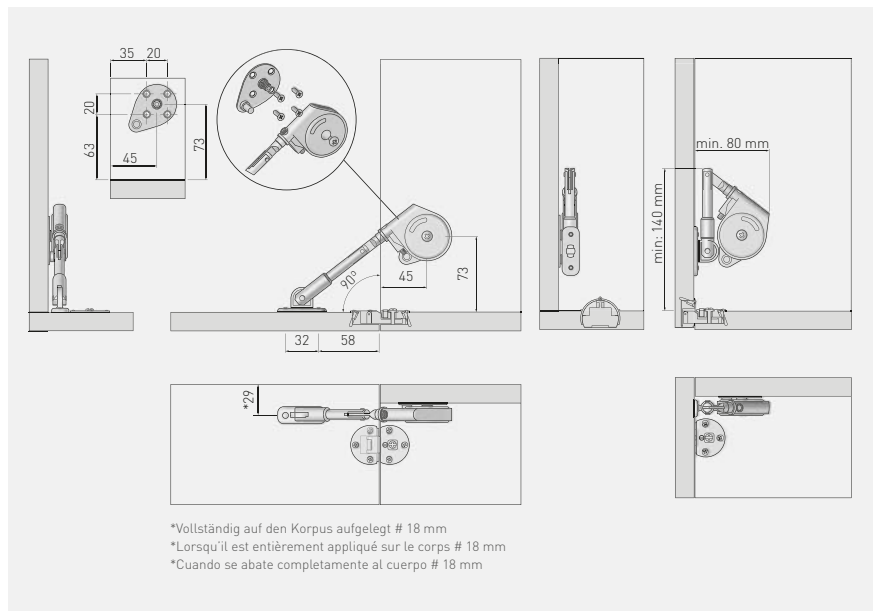

Dämpfer für Klappen VIM, lang  
 Vérin VIM pour porte abattante, long  
 Amortiguador VIM para puertas de mueble-bar brazo, largo



Produkt kompatibel mit Klappenscharnier PD-MD-ZB  
 Produit compatible avec charnière d'abattant PD-MD-ZB  
 Producto compatible con bisagra de brazo PD-MD-ZB

Richtwerttabelle für die Wahl der Anzahl der Dämpfer in Abhängigkeit von der Klappenbreite und -höhe.  
 Tableau indicatif des valeurs de sélection de dispositifs d'ouverture, en fonction de la largeur et de la hauteur du volet.  
 Tabla indicativa de los valores de selección de elevadores en función de la anchura y la altura de la tapa.

		
PD-MDLIFT-P2-D	grau / gris / gris	Stahl acier acero



Höhe Hauteur Altura	Breite / Largeur / Anchura			
	600 mm	700 mm	800 mm	900 mm
350 mm	1	2	2	2
360 mm				
370 mm				
380 mm				
390 mm				
400 mm				

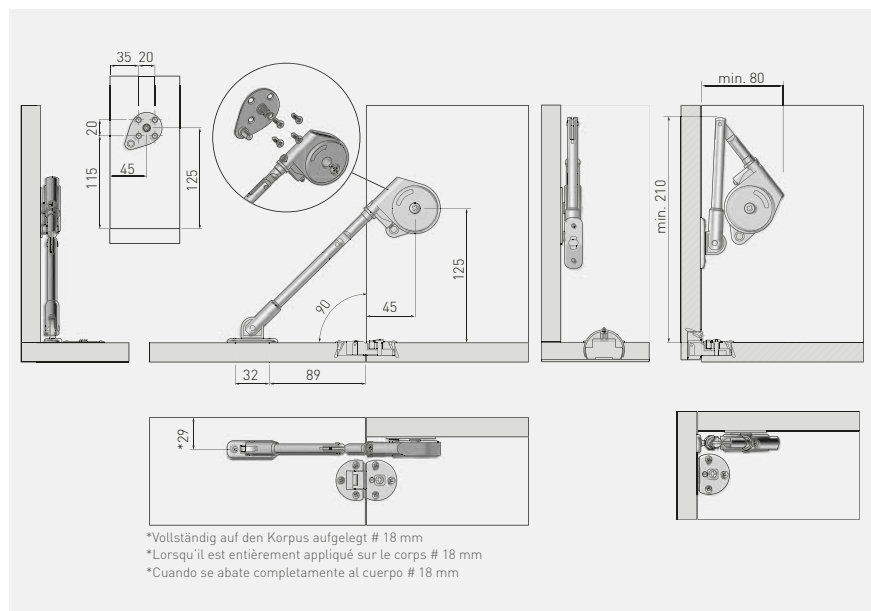

Öldämpfer für Klappen  
 Vérin hydraulique pour porte abattante  
 Amortiguador de aceite para puertas de mueble-bar

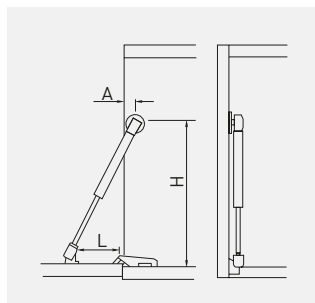

PD-ECGDL-060	60 N	grau gris gris	Stahl acier acero
PD-ECGDL-080	80 N		
PD-ECGDL-150	150 N		



Türöffnungswinkel, Angle d'ouverture de la porte, Ángulo de apertura de la puerta	Innenliegende Tür, Porte encastrée, Puerta empotrada,			Halb-aufschlagende Tür, Porte double, Puerta doble,			Aufschlagende Tür, Porte appliquée, Puerta de superficie,		
	H (mm)	L (mm)	A (mm)	H (mm)	L (mm)	A (mm)	H (mm)	L (mm)	A (mm)
90°	260	90	45	253	90	25	246	90	25

Türöffnungswinkel, Angle d'ouverture de la porte, Ángulo de apertura de la puerta	Kraft der Gasdruck- feder, Puissance de levage, Potencia del elevador	Türhöhe (mm) / Hauteur de porte (mm) / Altura de la puerta (mm)			
		300	400	500	600
		Türgewicht (kg) / Poids de la porte (kg) / Peso de la puerta (kg)			
 90°	60 N	1,8	1,3	1,1	0,9
	80 N	2,4	1,8	1,4	1,2
	150 N	4,1	3,2	2,3	2,1

## Bremsklappenhalter Compas de soufflet Compás abatible

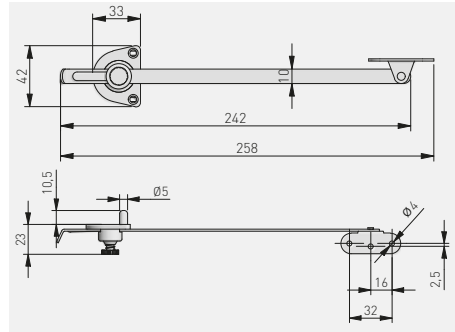

	INFO		
MR-SPG-UNI-GAL*	Universeller Bremsklappenhalter, galvanisiert Compas de soufflet universel autobloquant, galvanisé Compás abatible universal galvanizado con autofrenado	grau gris gris	Stahl + Kunststoff, acier + plastique, acero + plástico
MR-SPG-UNI-OC	Universeller Bremsklappenhalter, galvanisiert Compas de soufflet universel autobloquant, galvanisé Compás abatible universal galvanizado con autofrenado		



\*Produkt erhältlich auf individuelle Bestellung / Produit disponible sur demande / Producto disponible bajo demanda

Klappenhöhe (mm) Hauteur du volet (mm) Altura de puerta abatible (mm)	Klappenbreite (mm) Largeur du volet (mm) Anchura de puerta abatible (mm)							
	300	400	500	600	700	800	900	1000
320	1,1	1,5	1,9	2,1	2,6	2,9	3,3	3,6
350	1,2	1,6	2,0	2,5	2,9	3,3	3,7	4,0
400	1,4	1,8	2,3	2,8	3,3	3,7	4,2	4,6
450	1,6	2,1	2,6	3,1	3,7	4,2	4,7	5,3
500	1,8	2,3	2,9	3,5	4,1	4,7	5,3	5,8
550	1,9	2,6	3,2	3,9	4,5	5,1	5,8	6,4
600	2,1	2,8	3,5	4,2	4,9	5,6	6,3	7,0

Klappengewicht in kg (Spanplatte: Dicke 18 mm, Dichte=650 kg/m<sup>3</sup>)  
 Poids du volet en kg (panneau de particules: épaisseur 18 mm, densité=650 kg/m<sup>3</sup>)  
 Peso de puerta abatible en kg (aglomerado: grosor 18 mm, densidad=650 kg/m<sup>3</sup>)

\*mit breiteren Klappen - 2 Streben werden empfohlen  
 \*para solapas más anchas - se sugieren 2 compases  
 \*pour des volets plus larges - suggéré 2 compas mécaniques

Unterflurführung Modern Slide Pro  
 Guides de montage inférieur Modern Slide Pro  
 Guías de montaje inferior Modern Slide Pro



Schrankkante / bord de l'armoire / borde del armario





1. Führung links/rechts  
 glissière gauche/droite  
 guía izquierda/derecha

2. Kupplung links/rechts + Schrauben  
 accouplement gauche/droite + vis  
 acoplamiento izquierdo/derecho + tornillos

NL = Nennlänge der Führung  
 longueur nominale de la glissière  
 longitud nominal de la guía

AV = Auszugsverlust  
 perte de coulissement  
 pérdida de extensión

Installationshinweis: Für einwandfreie Funktion der Schublade darf die Breite der Schublade die Nennlänge der Führung nicht überschreiten.  
 Remarques d'installation: Pour un fonctionnement correct des tiroirs, leur largeur ne doit pas dépasser la longueur nominale de la glissière.  
 Notas de instalación: Para el correcto funcionamiento del cajón, su ancho no debe exceder la longitud nominal de la guía.

	$L$ mm	$AV$ mm		$kg$ ↓		
PB-3D0SHX18-300-PRO	300	30	Vollauszug totale completa	35	verzinkt galvanisé galvanizado	Stahl acier acero
PB-3D0SHX18-350-PRO	350	30				
PB-3D0SHX18-400-PRO	400	30				
PB-3D0SHX18-450-PRO	450	30				
PB-3D0SHX18-500-PRO	500	30				
PB-3D0SHX18-550-PRO	550	30				

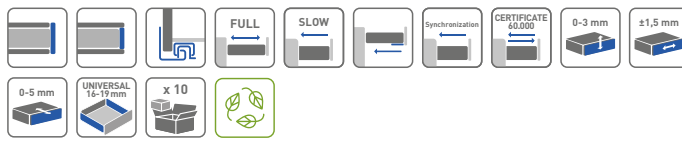



Unterflurführung mit Dämpfung 0SHX-18 3D  
 Coulisses tiroir, fermeture amortie 3D 0SHX-18 3D  
 Guía de montaje inferior con sistema de retención 0SHX-18 3D







Schrankkante / bord de l'armoire / borde del armario

1. Führung links/rechts  
 glissière gauche/droite  
 guía izquierda/derecha  
 2. Kupplung links/rechts + Schrauben  
 accouplement gauche/droite + vis  
 acoplamiento izquierdo/derecho + tornillos

NL = Nennlänge der Führung  
 longueur nominale de la glissière  
 longitud nominal de la guía

AV = Auszugsverlust  
 perte de coulissement  
 pérdida de extensión

Installationshinweis: Für einwandfreie Funktion der Schublade darf die Breite der Schublade die Nennlänge der Führung nicht überschreiten.  
 Remarques d'installation: Pour un fonctionnement correct des tiroirs, leur largeur ne doit pas dépasser la longueur nominale de la glissière.  
 Notas de instalación: Para el correcto funcionamiento del cajón, su ancho no debe exceder la longitud nominal de la guía.

	$L$ mm	$AV$ mm		kg		
PB-3D0SHX18-250-H	250	16	Vollauszug totale completa	30	verzinkt galvanisé galvanizado	Stahl acier acero
PB-3D0SHX18-300-H	300					
PB-3D0SHX18-350-H	350					
PB-3D0SHX18-400-H	400					
PB-3D0SHX18-450-H	450					
PB-3D0SHX18-500-H	500					
PB-3D0SHX18-550-H	550					
PB-3D0SHX18-600-H	600					

UNIVERSAL 16-19 mm

x 10

FRIENDLY

SLOW

FULL

CERTIFICATE 60000

0-2,5 mm

±1,5 mm

0-2 mm

Unterflurführung mit Dämpfung 0SHX  
 Coulisses tiroir, fermeture amortie 0SHX  
 Guía de montaje inferior con sistema de retención 0SHX



Abstände zwischen den Montageöffnungen  
 Espacement des orifices de montage  
 Distancia entre los orificios de montaje

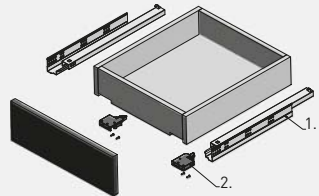
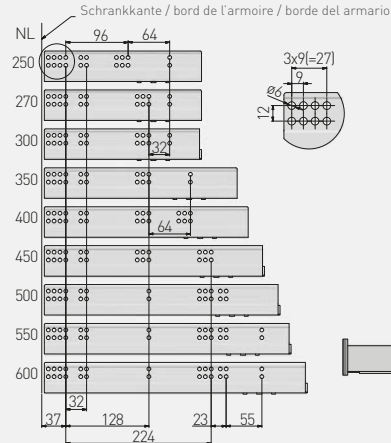

1. Führung links/rechts  
glissière gauche/droite  
guía izquierdo/derecha
2. Kupplung links/rechts/droite + Schrauben  
accouplement gauche/droite + vis  
acoplamiento izquierdo/derecho + tornillos

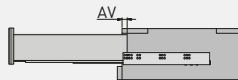

NL = Nennlänge der Führung  
 longueur nominale de la glissière  
 longitud nominal de la guía

AV = Auszugsverlust  
 perte de coulissement  
 pérdida de extensión

Installationshinweis: Für einwandfreie Funktion der Schublade darf die Breite der Schublade die Nennlänge der Führung nicht überschreiten.  
 Remarques d'installation: Pour un fonctionnement correct des tiroirs, leur largeur ne doit pas dépasser la longueur nominale de la glissière.  
 Notas de instalación: Para el correcto funcionamiento del cajón, su ancho no debe exceder la longitud nominal de la guía.

	L mm	AV mm		kg t		
PB-0SHX-250-A	250	16	Vollauszug totale completa	35		verzinkt galvanisé galvanizado
PB-0SHX-270-A	270					
PB-0SHX-300-A	300					
PB-0SHX-350-A	350					
PB-0SHX-400-A	400					
PB-0SHX-450-A	450					
PB-0SHX-500-A	500					
PB-0SHX-550-A	550					
PB-0SHX-600-A	600					Stahl acier acero



Unterflurführung mit Dämpfung GCHX18-H  
 Coulisses tiroir, fermeture amortie GCHX18-H  
 Guía de montaje inferior con sistema de retención GCHX18-H



Schrankkante / bord de l'armoire / borde del armario

1. Führung links/rechts / glissière gauche/droite / guía izquierda/derecha  
 2. Kupplung links/rechts + Schrauben / accouplement gauche/droite + vis / acoplamiento izquierdo/derecho + tornillos

NL = Nennlänge der Führung / longueur nominale de la glissière / longitud nominal de la guía  
 AV = Auszugsverlust / perte de coulisement / pérdida de extensión

Installationshinweis: Für einwandfreie Funktion der Schublade darf die Breite der Schublade die Nennlänge der Führung nicht überschreiten.  
 Remarques d'installation: Pour un fonctionnement correct des tiroirs, leur largeur ne doit pas dépasser la longueur nominale de la glissière.  
 Notas de instalación: Para el correcto funcionamiento del cajón, su ancho no debe exceder la longitud nominal de la guía.

	L mm	AV mm	kg			
PB-GCHX18-300-H	300	88,5 mm	Teilauszug partielle parcial	25 kg	verzinkt galvanisé galvanizado	Stahl acier acero
PB-GCHX18-350-H	350					
PB-GCHX18-400-H	400	118,5 mm				
PB-GCHX18-450-H	450					
PB-GCHX18-500-H	500					
PB-GCHX18-550-H	550					

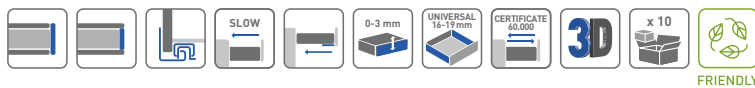

Unterflurführung Modern Slide Pro push to open  
 Guides de montage inférieur Modern Slide Pro push to open  
 Guías de montaje inferior Modern Slide Pro push-to-open

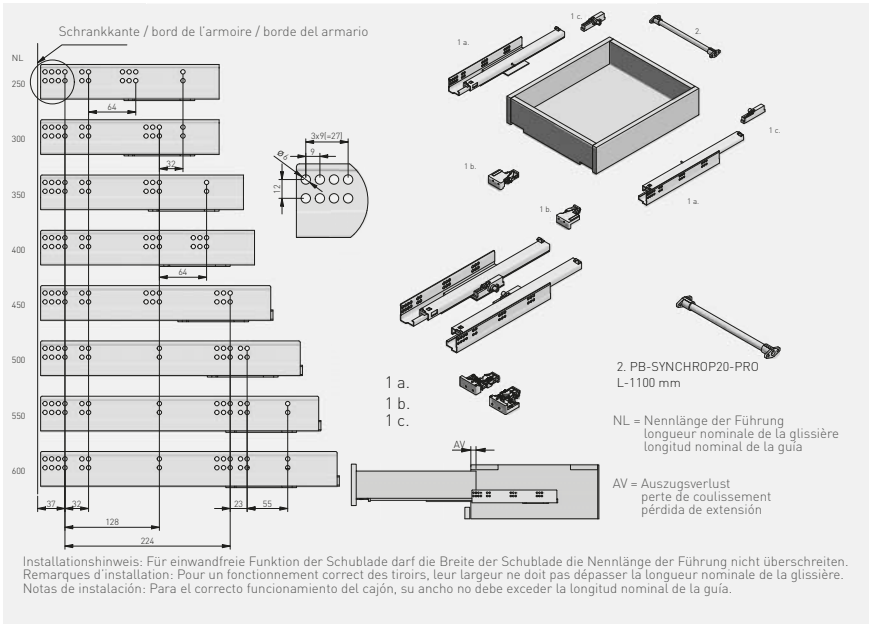

	L mm	AV mm		kg 1		
PB-3D0FP018-250-PRO	250	5	Vollauszug totale completa	35		verzinkt galvanisé galvanizado
PB-3D0FP018-300-PRO	300	-				
PB-3D0FP018-350-PRO	350	-				
PB-3D0FP018-400-PRO	400	-				
PB-3D0FP018-450-PRO	450	-				
PB-3D0FP018-500-PRO	500	-				
PB-3D0FP018-550-PRO	550	-				
PB-3D0FP018-600-PRO	600	-				Stahl acier acero
PB-SYNCHROP20-PRO	1100	-				Kunststoff / plastique / plástico
PB-SYNCHROP20-PRO-MOC	-	-				



Halterung für Sockelschubladen MORE SPACE  
 Support de tiroir sous plinthe MORE SPACE  
 Soporte del cajón de zócalo MORE SPACE



PB-WSPCOK

verzinkt / galvanisé / galvanizado

Stahl / acier / acero

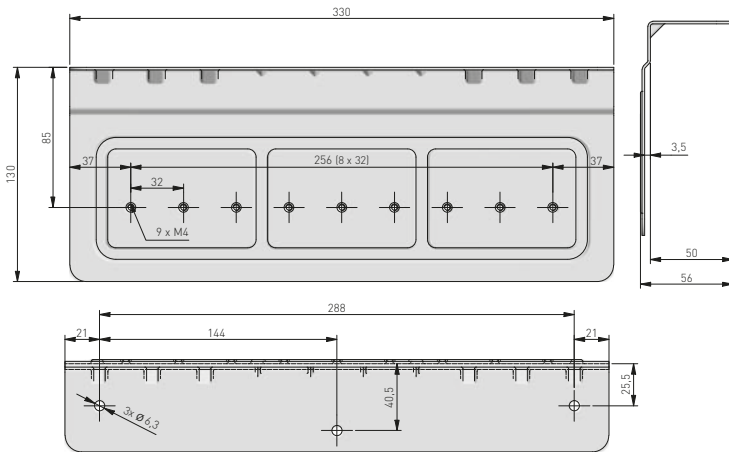

Unterflurführung Push-to-Open 0FPO18  
 Coulisses tiroir, push to open 0FPO18  
 Guía de montaje inferior push to open 0FPO18



Einsatzmöglichkeit der Stabilisierungsrollen  
 PB-D-P20STAB  
 Possibilitè d'utiliser un stabilisateur  
 PB-D-P20STAB  
 Posibilidad de utilizar un estabilizador  
 PB-D-P20STAB

Schränkkante / bord de l'armoire / borde del armario

NL = Nennlänge der Führung  
 longueur nominale de la glissière  
 longitud nominal de la guía

AV = Auszugsverlust  
 perte de coulissement  
 pérdida de extensión

Installationshinweis: Für einwandfreie Funktion der Schublade darf die Breite der Schublade die Nennlänge der Führung nicht überschreiten.  
 Remarques d'installation: Pour un fonctionnement correct des tiroirs, leur largeur ne doit pas dépasser la longueur nominale de la glissière.  
 Notas de instalación: Para el correcto funcionamiento del cajón, su ancho no debe exceder la longitud nominal de la guía.

	NL mm	AV mm		Kg		
PB-0FPO18-250	250	26	Vollauszug totale completa	25	verzinkt galvanisé galvanizado	Stahl acier acero
PB-0FPO18-300	300					
PB-0FPO18-350	350					
PB-0FPO18-400	400					
PB-0FPO18-450	450					
PB-0FPO18-500	500					
PB-0FPO18-550	550					
PB-0FPO18-600	600					



Unterflurführung mit Dämpfung G10HX-H  
 Coulisses tiroir, fermeture amortie G10HX-H  
 Guías de montaje inferior con sistema de retención G10HX-H









Schrankkante / bord de l'armoire / borde del armario

NL = Nennlänge der Führung  
 longueur nominale de la glissière  
 longitud nominal de la guía

AV = Auszugsverlust  
 perte de coulissement  
 pérdida de extensión

Installationshinweis: Für einwandfreie Funktion der Schublade darf die Breite der Schublade die Nennlänge der Führung nicht überschreiten.  
 Remarques d'installation: Pour un fonctionnement correct des tiroirs, leur largeur ne doit pas dépasser la longueur nominale de la glissière.  
 Notas de instalación: Para el correcto funcionamiento del cajón, su ancho no debe exceder la longitud nominal de la guía.

		 L mm	 AV mm		 kg		
PB-G10HX300-H		300	83	Teilauszug partielle parcial	25		Stahl acier acero
PB-G10HX350-H		350					
PB-G10HX450-H		450					
PB-G10HX500-H		500					
PB-G10HX550-H		550					

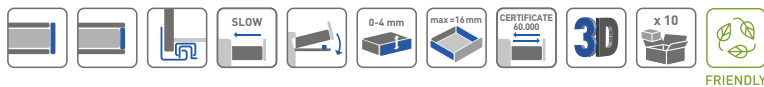

Kugelführung H53  
Glissière à billes H53  
Guía de bolas H53

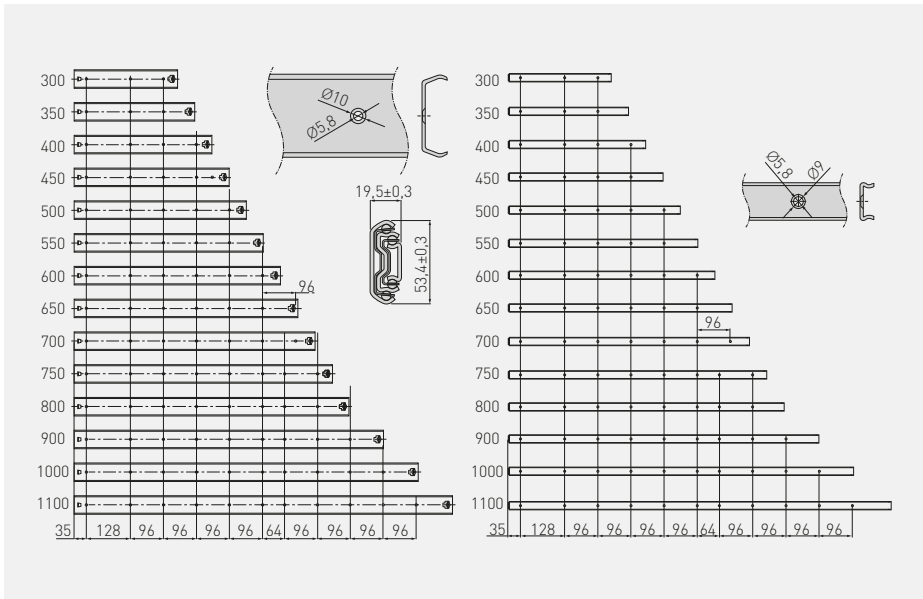

	L mm	AV mm		kg				L mm	AV mm		kg			
PK-0-H53-300	300	-	Vollau- szug totale completa	100	verzinkt galvanisé galvanizado	Stahl acier acero	PK-0-H53-650	650	-	Vollau- szug totale completa	100	verzinkt galvanisé galvanizado	Stahl acier acero	
PK-0-H53-350	350	-					PK-0-H53-700	700	-					
PK-0-H53-400	400	-					PK-0-H53-750	750	-					
PK-0-H53-450	450	-					PK-0-H53-800	800	-					
PK-0-H53-500	500	-					PK-0-H53-900	900	-					
PK-0-H53-550	550	-					PK-0-H53-1000	1000	-					
PK-0-H53-600	600	-					PK-0-H53-1100	1100	-					

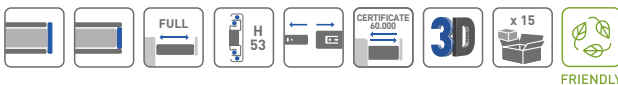









Kugelführung VersalitePlus+  
Glissière à billes VersalitePlus+  
Guía de bolas VersalitePlus+



Schrankkante / bord de l'armoire / borde del armario

NL = Nennlänge der Führung  
longueur nominale de la glissière  
longitud nominal de la guía

AV = Auszugsverlust  
perte de coulissement  
pérdida de extensión

Installationshinweis: Für einwandfreie Funktion der Schublade darf die Breite der Schublade die Nennlänge der Führung nicht überschreiten.  
Remarques d'installation: Pour un fonctionnement correct des tiroirs, leur largeur ne doit pas dépasser la longueur nominale de la glissière.  
Notas de instalación: Para el correcto funcionamiento del cajón, su ancho no debe exceder la longitud nominal de la guía.

	L mm	AV mm		kg		
PK-L-H45-250-B	250	52	Vollauszug totale completa	40	verzinkt galvanisé galvanizado	Stahl acier acero
PK-L-H45-300-B	300	4				
PK-L-H45-350-B	350					
PK-L-H45-400-B	400					
PK-L-H45-450-B	450					
PK-L-H45-500-B	500					
PK-L-H45-550-B	550					
PK-L-H45-600-B	600					

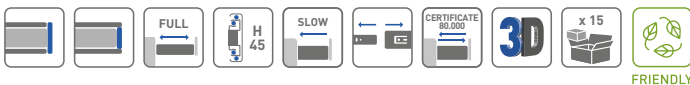





Kugelführung H45 mit Dämpfung VERSALITE\*  
 Glissière à billes VERSALITE avec avec fermeture amortie H45\*  
 Guía de bolas VERSALITE con sistema de retención H45\*



Schrankkante / bord de l'armoire / borde del armario

NL = Nennlänge der Führung  
 longueur nominale de la glissière  
 longitud nominal de la guía

AV = Auszugsverlust  
 perte de coulissement  
 pérdida de extensión

brak w L-300  
 lack in L-300  
 нет отверстия L-300

Installationshinweis: Für einwandfreie Funktion der Schublade darf die Breite der Schublade die Nennlänge der Führung nicht überschreiten.  
 Remarques d'installation: Pour un fonctionnement correct des tiroirs, leur largeur ne doit pas dépasser la longueur nominale de la glissière.  
 Notas de instalación: Para el correcto funcionamiento del cajón, su ancho no debe exceder la longitud nominal de la guía.

		 L mm	 AV mm	 kg			
PK-L-H45-250-A		250**	55	Vollauszug totale completa	30	verzinkt galvanisé galvanizado	Stahl acier acero
PK-L-H45-300-A		300	15				
PK-L-H45-350-A		350	5				
PK-L-H45-400-A		400					
PK-L-H45-450-A		450					
PK-L-H45-500-A		500					
PK-L-H45-550-A		550					
PK-L-H45-600-A		600	0				





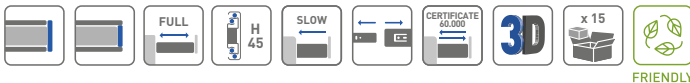

\*Produkt erhältlich auf individuelle Bestellung / Produit disponible sur demande / Producto disponible bajo demanda

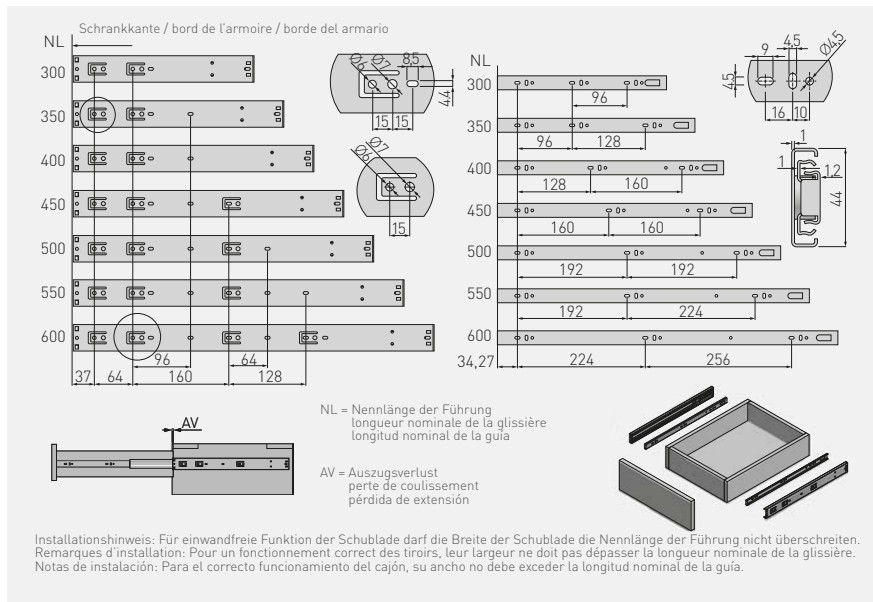
\*Kein Vollauszug / Pas d'extension complète / Sin extensión total



Kugelführung H45 mit Dämpfung VERSALITE LIGHT  
 Glissière à billes VERSALITE LIGHT avec fermeture amortie H45  
 Guía de bolas VERSALITE LIGHT con sistema de retención H45



		 L mm	 AV mm				
PK-L-H45-300-GX		300*	50	Vollauszug totale completa	25	verzinkt galvanisé galvanizado	Stahl acier acero
PK-L-H45-350-GX		350	20				
PK-L-H45-400-GX		400	-				
PK-L-H45-450-GX		450	-				
PK-L-H45-500-GX		500	-				
PK-L-H45-550-GX		550	-				
PK-L-H45-600-GX		600	-				



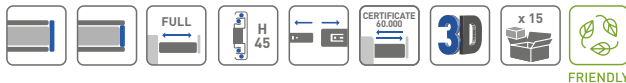



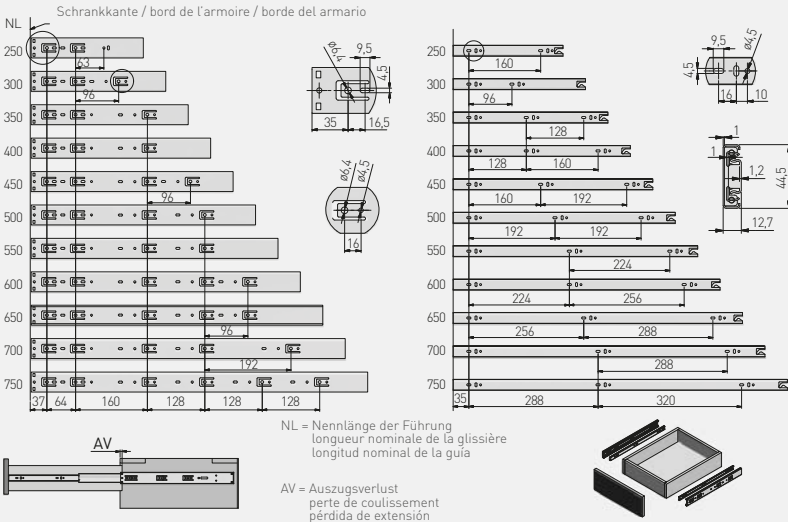

\*\*Kein Vollauszug / Pas d'extension complète / Sin extensión total



Kugelführung H45 mit Selbsteinzug  
 Glissière à billes avec fermeture automatique H45  
 Guía de bolas con autocierre H45



Installationshinweis: Für einwandfreie Funktion der Schublade darf die Breite der Schublade die Nennlänge der Führung nicht überschreiten.  
 Remarques d'installation: Pour un fonctionnement correct des tiroirs, leur largeur ne doit pas dépasser la longueur nominale de la glissière.  
 Notas de instalación: Para el correcto funcionamiento del cajón, su ancho no debe exceder la longitud nominal de la guía.

		 L mm	 AV mm		 kg			
PK-S-H45-250		250	22	Vollauszug totale completa	35	verzinkt galvanisé galvanizado	Stahl acier acero	15
PK-S-H45-300		300						
PK-S-H45-350		350						
PK-S-H45-400		400						
PK-S-H45-450		450						
PK-S-H45-500		500						
PK-S-H45-550		550						10
PK-S-H45-600		600						
PK-S-H45-650		650						
PK-S-H45-700		700						





Kugelführung H45 PRESTIGE  
Glissière à billes H45 PRESTIGE  
Guía de bolas H45 PRESTIGE

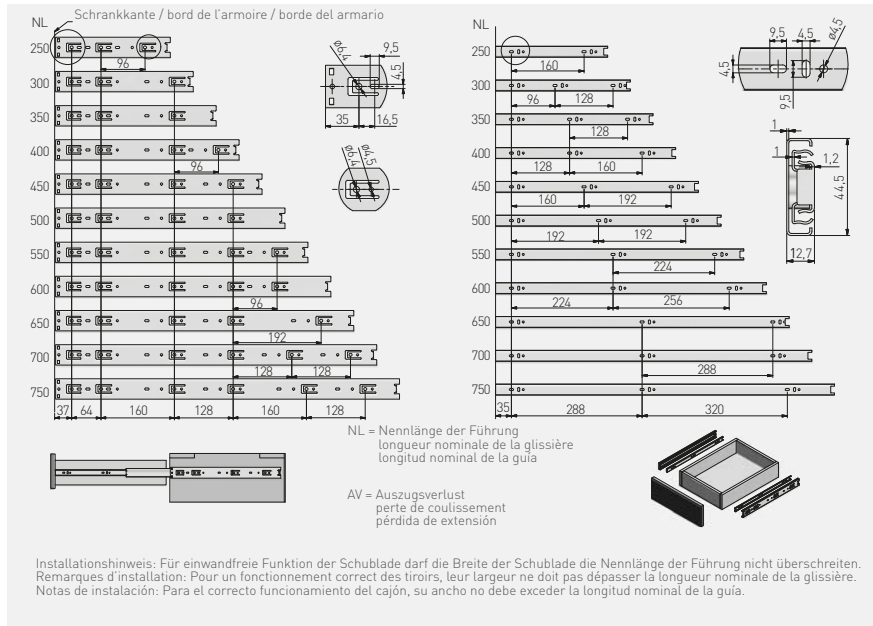

	L mm	AV mm	kg			
PK-0-H45-250	250	-	35	verzinkt galvanisé galvanizado	Stahl acier acero	15
PK-0-H45-300	300					
PK-0-H45-350	350					
PK-0-H45-400	400					
PK-0-H45-450	450					
PK-0-H45-500	500					
PK-0-H45-550	550					10
PK-0-H45-600	600					
PK-0-H45-700	700					

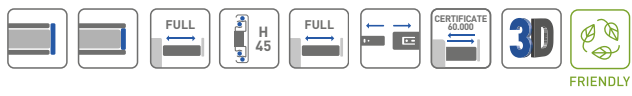

Kugelführung H45 PRO  
Glissière à billes H45 PRO  
Guía de bolas H45 PRO









Schrankkante / bord de l'armoire / borde del armario

NL = Nennlänge der Führung  
longueur nominale de la glissière  
longitud nominal de la guía

AV = Auszugsverlust  
perte de coulissement  
pérdida de extensión

NL (mm)	*a (mm)
300	21
350	49
400	89
450	94,5
500	115
550	115,5
600	156
650	167

Installationshinweis: Für einwandfreie Funktion der Schublade darf die Breite der Schublade die Nennlänge der Führung nicht überschreiten.  
Remarques d'installation: Pour un fonctionnement correct des tiroirs, leur largeur ne doit pas dépasser la longueur nominale de la glissière.  
Notas de instalación: Para el correcto funcionamiento del cajón, su ancho no debe exceder la longitud nominal de la guía.

		 L (mm)	 AV (mm)					
PK-PRO-H45-250		250	5	Vollauszug totale completa	50	verzinkt galvanisé galvanizado	Stahl acier acero	15
PK-PRO-H45-300		300						
PK-PRO-H45-350		350						
PK-PRO-H45-400		400						
PK-PRO-H45-450		450						
PK-PRO-H45-500		500						
PK-PRO-H45-550		550						
PK-PRO-H45-600		600						
PK-PRO-H45-650		650						

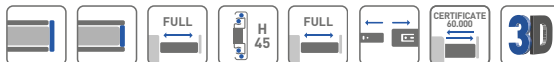



Kugelführung H45 Push-to-Open GX  
 Glissière à billes push to open H45 GX  
 Guía de bolas push to open H45 GX



Einsatzmöglichkeit der Stabilisierungsrollen  
 PB-D-P20STAB  
 Possibilité d'utiliser un stabilisateur  
 PB-D-P20STAB  
 Posibilidad de utilizar un estabilizador  
 PB-D-P20STAB

Schrankkante / bord de l'armoire / borde del armario

NL	37	96	64	128
300				
350				
400				
450				
500				
550				
600				

NL = Nennlänge der Führung  
 longueur nominale de la glissière  
 longitud nominal de la guía

AV = Auszugsverlust  
 perte de coulissement  
 pérdida de extensión

Installationshinweis: Für einwandfreie Funktion der Schublade darf die Breite der Schublade die Nennlänge der Führung nicht überschreiten.  
 Remarques d'installation: Pour un fonctionnement correct des tiroirs, leur largeur ne doit pas dépasser la longueur nominale de la glissière.  
 Notas de instalación: Para el correcto funcionamiento del cajón, su ancho no debe exceder la longitud nominal de la guía.

	L mm	AV mm		kg		
PK-P-H45-300-GX	300*	30	Vollauszug totale completa	25	verzinkt galvanisé galvanizado	Stahl acier acero
PK-P-H45-350-GX	350					
PK-P-H45-400-GX	400					
PK-P-H45-450-GX	450					
PK-P-H45-500-GX	500					
PK-P-H45-550-GX	550					
PK-P-H45-600-GX	600					

\*Kein Vollauszug / Pas d'extension complète / Sin extensión total



Kugelführung H45 GX1  
 Glissière à billes H45 GX1  
 Guía de bolas H45 GX1









Schrankkante / bord de l'armoire / borde del armario

NL = Nennlänge der Führung  
 longueur nominale de la glissière  
 longitud nominal de la guía

AV = Auszugsverlust  
 perte de coulissement  
 pérdida de extensión

Installationshinweis: Für einwandfreie Funktion der Schublade darf die Breite der Schublade die Nennlänge der Führung nicht überschreiten.  
 Remarques d'installation: Pour un fonctionnement correct des tiroirs, leur largeur ne doit pas dépasser la longueur nominale de la glissière.  
 Notas de instalación: Para el correcto funcionamiento del cajón, su ancho no debe exceder la longitud nominal de la guía.

		 L mm	 AV mm		 30g g		
PK-0H45250GX1		250	5	Vollauszug totale completa	30	verzinkt galvanisé galvanizado	Stahl acier acero
PK-0H45300GX1		300					
PK-0H45350GX1		350					
PK-0H45400GX1		400					
PK-0H45450GX1		450					
PK-0H45500GX1		500					
PK-0H45550GX1		550					
PK-0H45600GX1		600					
PK-0H45650GX1		650					
PK-0H45700GX1		700					



Kugelführung H45 HK  
 Glissière à billes H45 HK  
 Guía de bolas H45 HK

NEW

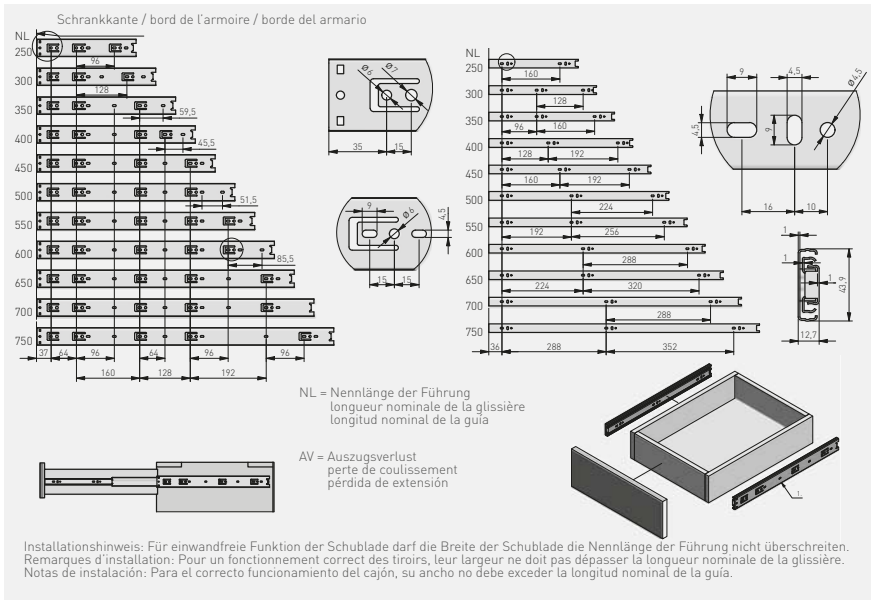

	L mm	AV mm	kg		
PK-0H45250HK	250	5	Vollauszug totale completa	30	verzinkt galvanisé galvanizado
PK-0H45300HK	300				
PK-0H45350HK	350				
PK-0H45400HK	400				
PK-0H45450HK	450				
PK-0H45500HK	500				
PK-0H45550HK	550				
PK-0H45600HK	600				
PK-0H45650HK	650				
PK-0H45700HK	700				
PK-0H45750HK	750				Stahl acier acero



Kugelführung H45 GX2-A  
 Glissière à billes H45 GX2-A  
 Guía de bolas H45 GX2-A



Schrankkante / bord de l'armoire / borde del armario

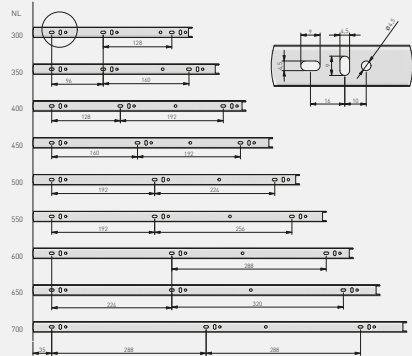
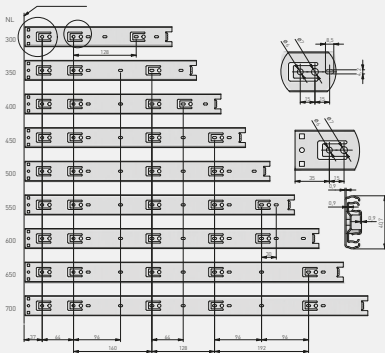

NL = Nennlänge der Führung  
 longueur nominale de la glissière  
 longitud nominal de la guía

AV = Auszugsverlust  
 perte de coulissement  
 pérdida de extensión

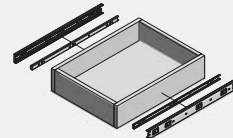
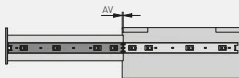

Installationshinweis: Für einwandfreie Funktion der Schublade darf die Breite der Schublade die Nennlänge der Führung nicht überschreiten.  
 Remarques d'installation: Pour un fonctionnement correct des tiroirs, leur largeur ne doit pas dépasser la longueur nominale de la glissière.  
 Notas de instalación: Para el correcto funcionamiento del cajón, su ancho no debe exceder la longitud nominal de la guía.







Part Number	Length L (mm)	Extension Loss AV (mm)	Weight (kg)	Material
PK-0H45300GX2-A	300	-	25	verzinkt galvanisé galvanizado
PK-0H45350GX2-A	350			
PK-0H45400GX2-A	400			
PK-0H45450GX2-A	450			
PK-0H45500GX2-A	500			
PK-0H45550GX2-A	550			
PK-0H45600GX2-A	600			
PK-0H45650GX2-A	650			
PK-0H45700GX2-A	700			

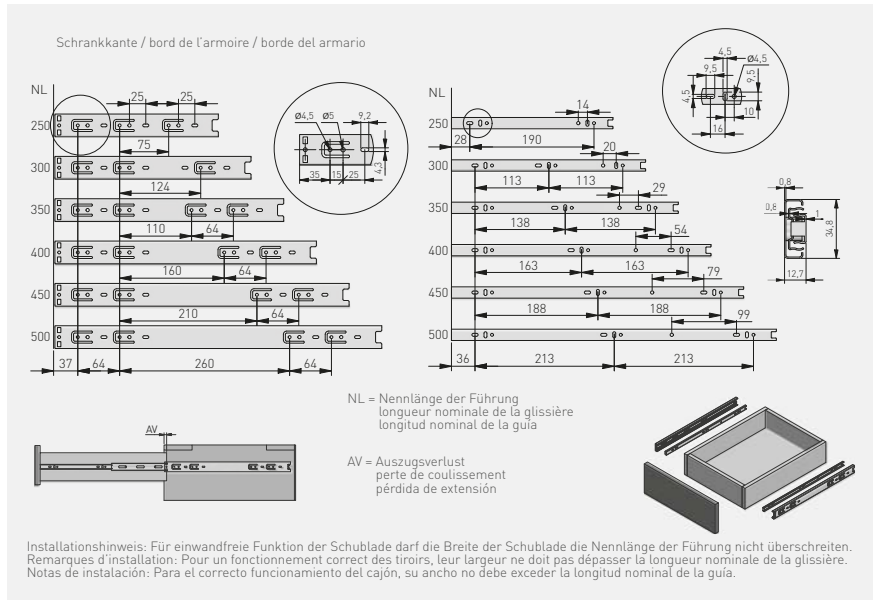

FRIENDLY

Kugelführung H35  
Glissière à billes H35  
Guía de bolas H35





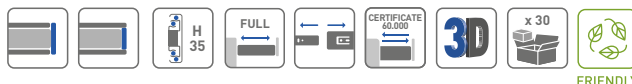



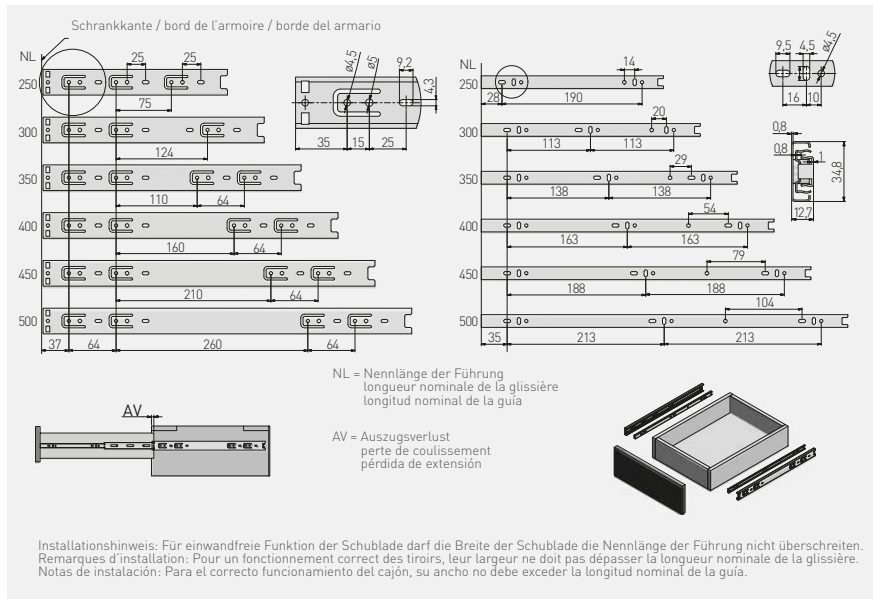

		 L mm	 AV mm		 kg		
PK-0H35-2500		300	4	Vollauszug totale completa	20	verzinkt galvanisé galvanizado	Stahl acier acero
PK-0H35-3000		300					
PK-0H35-3500		350					
PK-0H35-4000		400					
PK-0H35-4500		450					
PK-0H35-5000		500					





Kugelführung H35  
Glissière à billes H35  
Guía de bolas H35







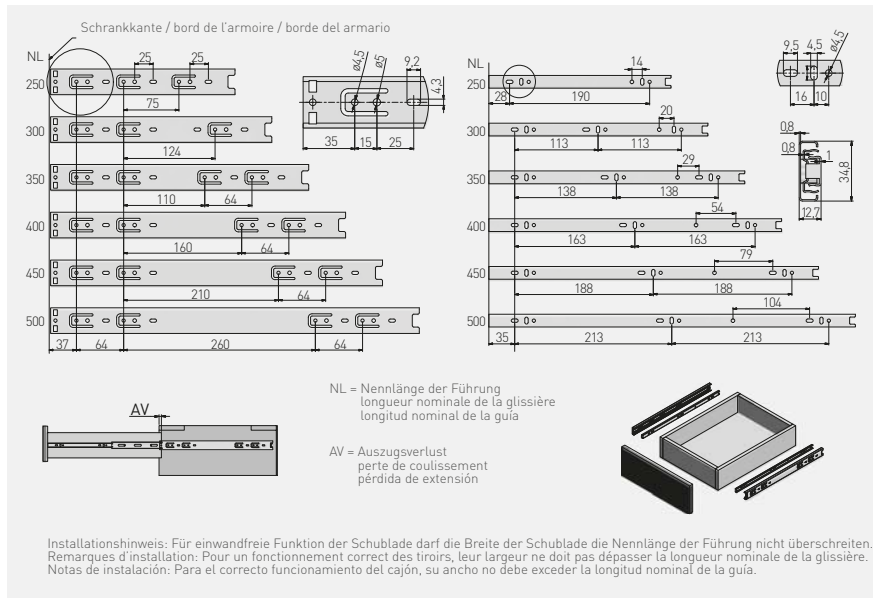

		 L mm	 AV mm		 kg			
PK-0-H35-250		250	4	Vollauszug totale completa	20	verzinkt galvanisé galvanizado	Stahl acier acero	20
PK-0-H35-300		300						
PK-0-H35-350		350						
PK-0-H35-400		400						
PK-0-H35-450		450						
PK-0-H35-500		500						



Kugelführung H35  
Glissière à billes H35  
Guía de bolas H35







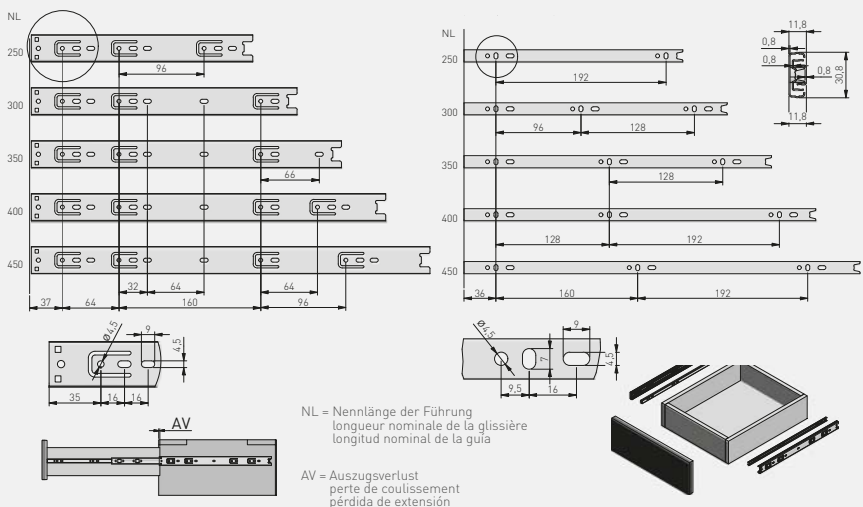

		 L mm	 AV mm	 kg				
PK-0-H35-2500L		250	4	Vollauszug totale completa	20	verzinkt galvanisé galvanizado	Stahl acier acero	30
PK-0-H35-3000L		300						20
PK-0-H35-3500L		350						20
PK-0-H35-4000L		400						20
PK-0-H35-4500L		450						20
PK-0-H35-5000L		500						20



Kugelführung H30  
Glissière à billes H30  
Guía de bolas H30







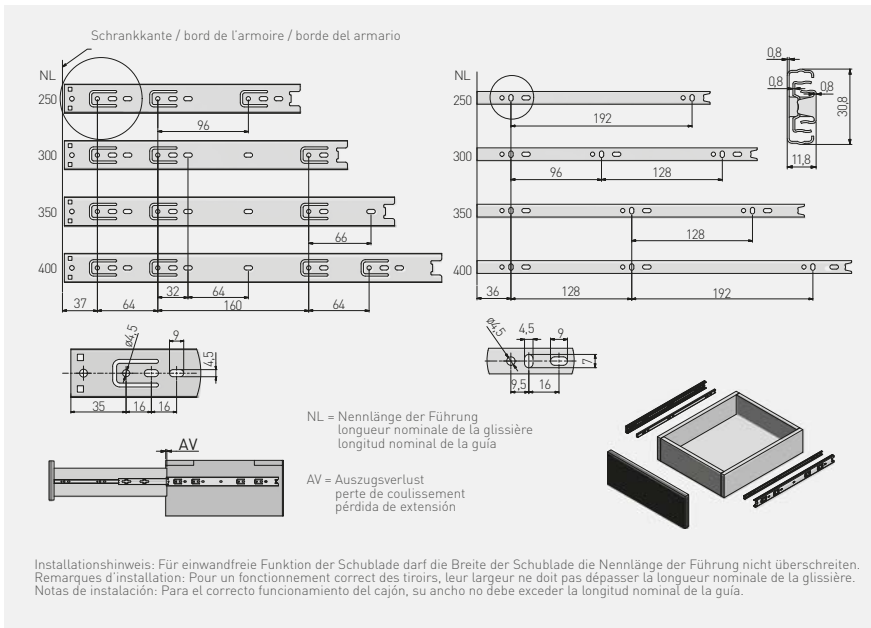

Installationshinweis: Für einwandfreie Funktion der Schublade darf die Breite der Schublade die Nennlänge der Führung nicht überschreiten.  
Remarques d'installation: Pour un fonctionnement correct des tiroirs, leur largeur ne doit pas dépasser la longueur nominale de la glissière.  
Notas de instalación: Para el correcto funcionamiento del cajón, su ancho no debe exceder la longitud nominal de la guía.

		 L mm	 AV mm		 kg		
PK-0H30-2500		250	-	Vollauszug totale completa	15	verzinkt galvanisé galvanizado	Stahl acier acero
PK-0H30-3000		300					
PK-0H30-3500		350					
PK-0H30-4000		400					
PK-0H30-4500		450					



Kugelführung H30  
Glissière à billes H30  
Guía de bolas H30







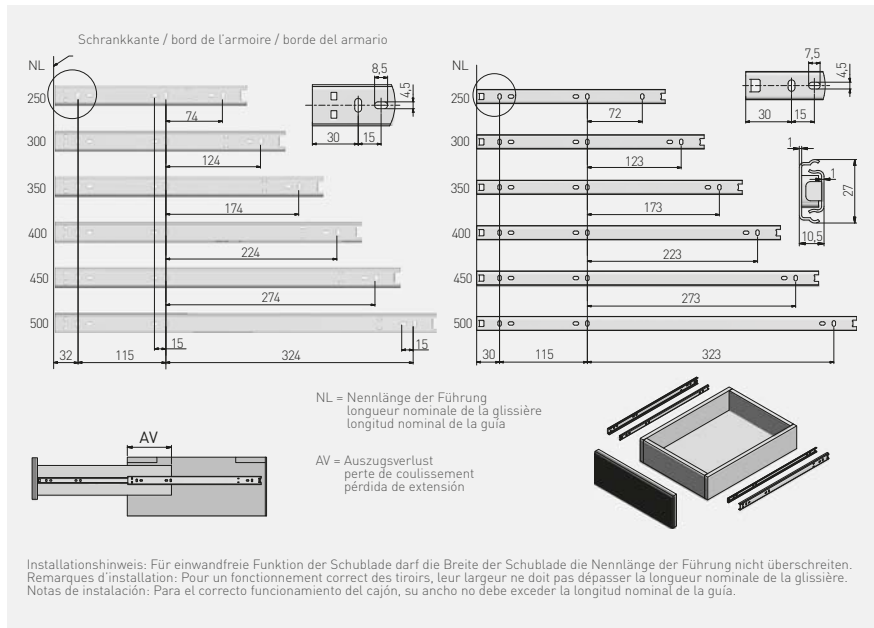

		 L mm	 AV mm				
PK-0H30-2500-A		250	-	Vollauszug totale completa	15	galvanisierter Stahl acier galvanisé acero galvanizado	Stahl acier acero
PK-0H30-3000-A		300					
PK-0H30-3500-A		350					
PK-0H30-4000-A		400					



Kugelführung H27  
Glissière à billes H27  
Guía de bolas H27



		 L mm	 AV mm		 kg		
PK-0H27-3000		300	109	Teilauszug partielle parcial	15	verzinkt galvanisé galvanizado	Stahl acier acero
PK-0H27-3500		350	124				
PK-0H27-4000		400	134				
PK-0H27-4500		450	149				
PK-0H27-5000		500	184				

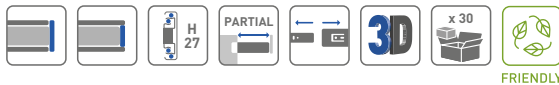

Kugelführung H27 für Tastaturablage  
 Glissière à billes pour tablette de clavier H27  
 Guía de bolas para bandeja de teclado H27

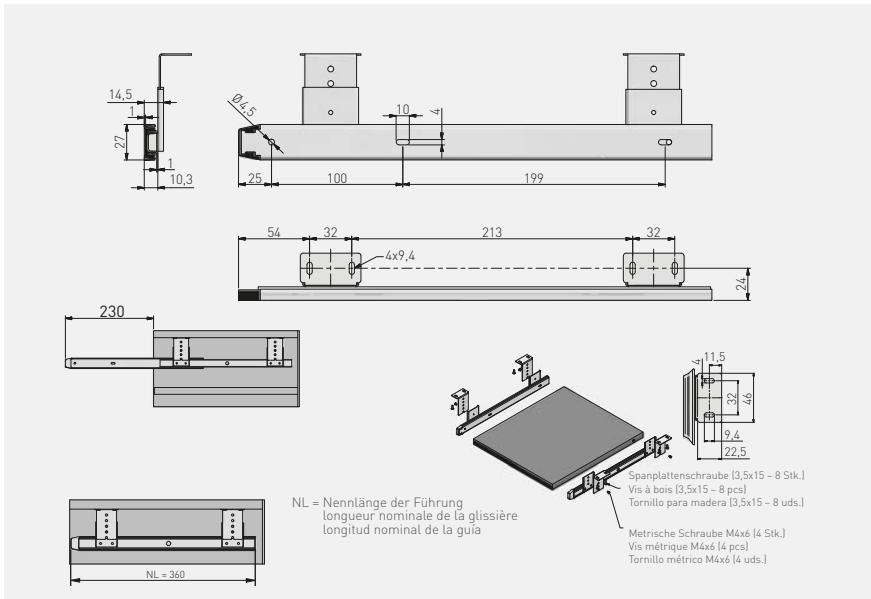

PK-0-000-027	360 mm	Teilauszug partielle parcial	5 kg	verzinkt galvanisé galvanizado	Stahl acier acero



Kugelführung H17  
Glissière à billes H17  
Guía de bolas H17

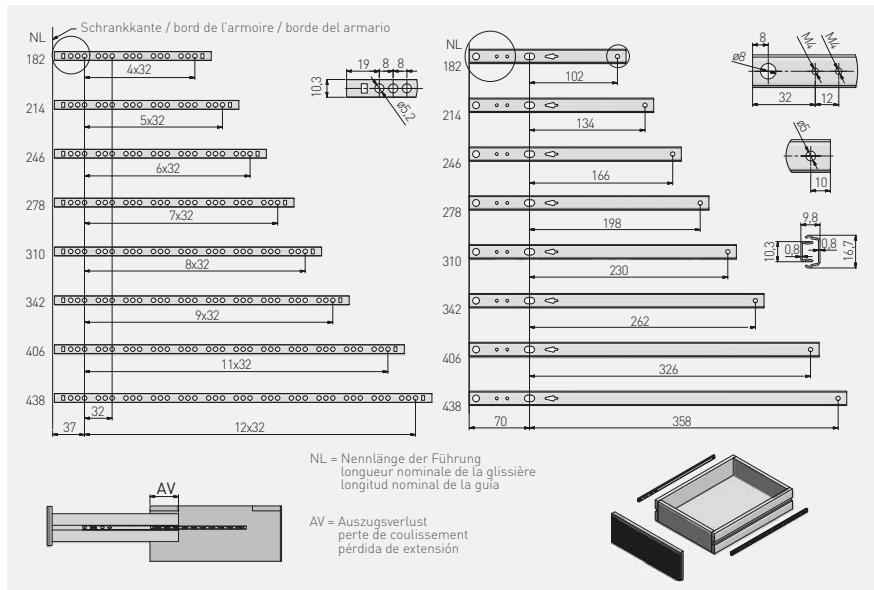

PK-0H17182XP	L mm	AV mm	kg	Material	Weight	
PK-0H17214XP	214	77	10	verzinkt galvanisé galvanizado	Stahl acier acero	
PK-0H17246XP	246					
PK-0H17278XP	278	100	10	verzinkt galvanisé galvanizado	Stahl acier acero	
PK-0H17310XP	310					
PK-0H17342XP	342					
PK-0H17406XP	406					
PK-0H17438XP	438					50



Rollschubführung 0B  
Coulisses tiroir rails 0B  
Guía de rodillos 0B

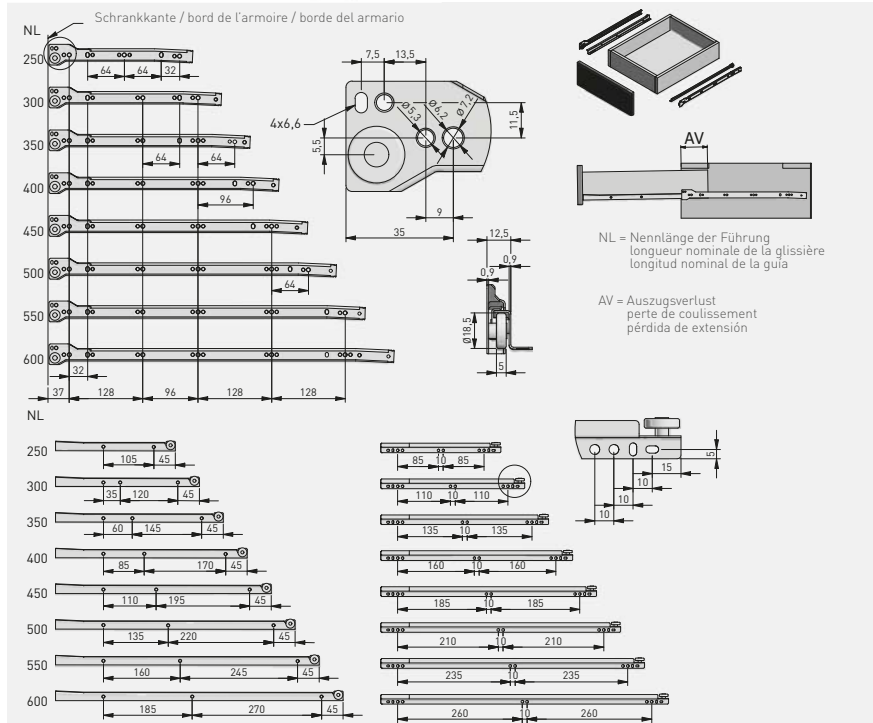

	L mm	AV mm	kg				L mm	AV mm	kg			
PR-0B-250-10	250						PR-0B-250-18*	250				
PR-0B-300-10	300						PR-0B-300-18*	300				
PR-0B-350-10	350	100					PR-0B-350-18*	350	100			
PR-0B-400-10	400						PR-0B-400-18*	400				
PR-0B-450-10	450						PR-0B-450-18*	450				
PR-0B-500-10	500	110					PR-0B-500-18*	500	110			
PR-0B-550-10	550	115					PR-0B-550-18*	550	115			
PR-0B-600-10	600	125					PR-0B-600-18*	600	125			



FRIENDLY



Rollschubführung 0B  
Coulisses tiroir rails 0B  
Guía de rodillos 0B



Schrankkante / bord de l'armoire / borde del armario

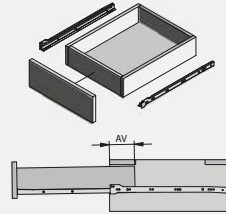
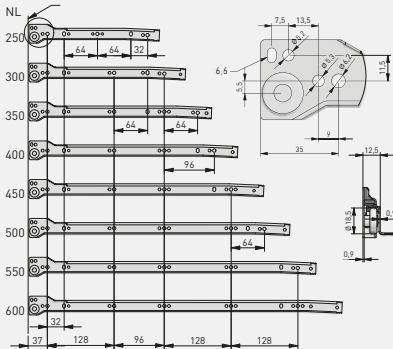

NL = Nennlänge der Führung  
longueur nominale de la glissière  
longitud nominal de la guía

AV = Auszugsverlust  
perte de coulissement  
pérdida de extensión

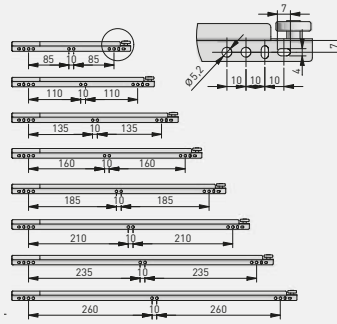
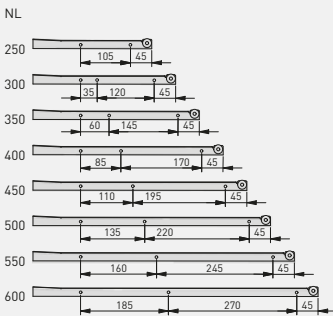

PR-0B-300-10-Z	300	100	Teilauszug partielle parcial	20	weiß blanc blanco	Stahl acier acero
PR-0B-350-10-Z	350					
PR-0B-400-10-Z	400					
PR-0B-450-10-Z	450					
PR-0B-350-18-Z*	350					
PR-0B-450-80-Z	450					



Führungssystem Metalbox MP  
 Glissière MP Metalbox MP  
 Guía Metalbox MP



Einbaumaße für Frontplattenmontage  
 Dimensions de montage de la fixation du panneau avant  
 Dimensiones de montaje para la fijación del frente

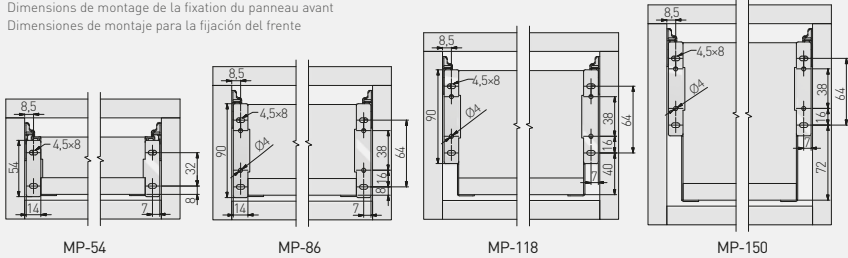





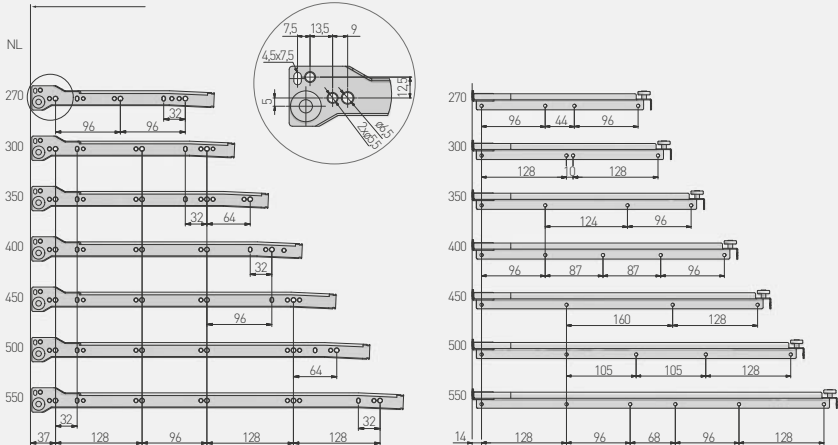



Abstände zwischen den Montageöffnungen  
 Espacement des orifices de montage  
 Distancia entre los orificios de montaje

Schrankkante / bord de l'armoire / borde del armario





FRIENDLY

		 H mm	 L mm	 AV mm		 kg ↓				
MP-054350-10	54	350	88	98	Teilauszug partielle parcial	25	lackiert peinture barnizado	weiß blanc blanco	Stahl acier acero	
MP-054400-10		400	88							
MP-054450-10		450								98
MP-054500-10		500								
MP-054450-80		450								88
MP-054500-80		500								
MP-086270-10	86	270	88	98				weiß blanc blanco		
MP-086300-10		300								
MP-086350-10		350								
MP-086400-10		400	118							
MP-086450-10		450								
MP-086500-10		500								
MP-086550-10		550	88							
MP-086350-80		350								
MP-086400-80		400								
MP-086450-80		450	98							
MP-086500-80		500								
MP-118350-10		118	350							88
MP-118400-10	400		88							
MP-118450-10	450									
MP-118500-10	500									
MP-150270-10	150	270	88	98				weiß blanc blanco		
MP-150300-10		300								
MP-150350-10		350								
MP-150400-10		400	118							
MP-150450-10		450								
MP-150500-10		500								
MP-150550-10		550	88							
MP-150350-80		350								
MP-150400-80		400			98					
MP-150450-80		450								
MP-150500-80		500								

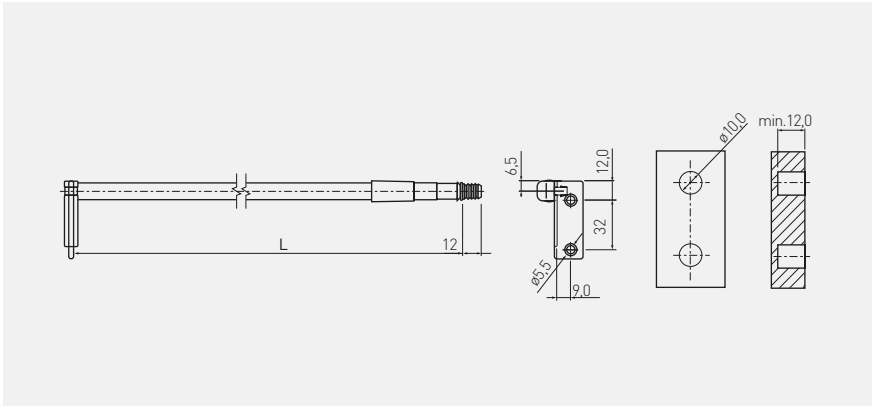
Reling mit Rückwandhalter links/rechts  
 Rail avec support de panneau arrière gauche/droite  
 Varilla con soporte del costado trasero izquierdo/derecho



		
RS-SZ-400-10	393 / 404	weiß blanc blanco
RS-SZ-450-10	443 / 454	
RS-SZ-500-10	493 / 504	

L – die tatsächliche Länge des Relings im Bereich (Lmin.; Lmax.) / longueur effective du rail dans l'intervalle (Lmin.; Lmax.) / longitud efectiva del carril en el rango (Lmin.; Lmax.)



Dämpfung für Rollschubführungen und Führungssysteme Metalbox 350-550 mm  
 Ralenteuseur pour glissières à billes et tiroirs de type Metalbox 350-550 mm  
 Sistema de retención para guías de rodillos y cajones de tipo Metalbox 350-550 mm

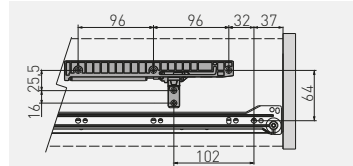

Rollschubführung / Glissière à rouleaux / Guía de rodillos

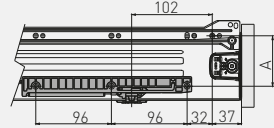

Metalbox / Metalbox / Metalbox

Seitenhöhe (mm)  
 hauteur latérale (mm)  
 Altura del panel lateral (mm)

	A
54	32
86	64
118	96
150	128



AM-MBSOFT-P2

25

grau  
 gris,  
 gris

Kunststoff  
 plastique  
 plástico



Stabilisierungsrolle  
 Rouleau stabilisateur  
 Rodillo estabilizador

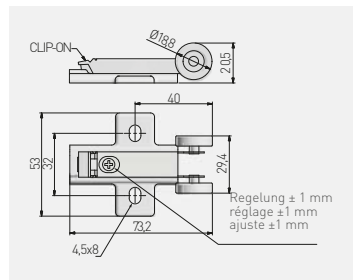

Für Schubladen mit Push-to-Open Führungen  
 Pour tiroirs à coffret équipés de glissières push to open  
 Para cajones con sistema de guías push to open



PB-D-P20STAB

Nickel / nickel / níquel

Stahl / acier / acero



**AXIS PRO**

Schubladensystem  
Composition de l'ensemble  
Elementos del juego

RÜCKWANDBEFESTIGUNG  
niedrig / mittelhoch / hoch / sehr hoch  
anthrazit / weiß

FIXATION DE PANNEAU ARRIÈRE  
bas / moyen / haut / très haut  
anthracite / blanc

FIJACIÓN DEL PANEL  
bajo / medio / alto / muy alto  
antracita / blanco

Ultradünne Zargen  
paroi latérale ultra-mince  
panel lateral ultrafino

ABDECKKAPPE  
FÜR EINSTELLÖFFNUNGEN  
anthrazit / weiß  
BOUCHONS DES TROUS DE RÉGULATION  
anthracite / blanc  
TAPA DE ORIFICIOS DE AJUSTE  
antracita / blanco

FRONTENBEFESTIGUNG + SCHRAUBEN  
FIXATION PANNEAU AVANT + VIS  
FIJACIÓN DEL FRENTE + TORNILLOS

FÜHRUNG  
L = 300-550 mm  
GLISSIÈRE  
L = 300-550 mm  
GUÍA  
L = 300-550 mm

ZARGE  
anthrazit / weiß  
L = 300-550 mm  
CÔTÉ DE TIROIR  
anthracite / blanc  
L = 300-550 mm  
PANEL LATERAL  
DEL CAJÓN  
antracita / blanco  
L = 300-550 mm



## AXIS PRO

Schublade niedrig A  
Jeu de tiroir bas A  
Juego cajón bajo A

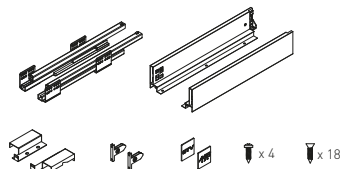

PB-AXISPRO-KPL250A	250	40	anthrazit anthracite antracita	lackiert peinture barnizado	Stahl acier acero
PB-AXISPRO-KPL300A	300				
PB-AXISPRO-KPL350A	350				
PB-AXISPRO-KPL400A	400				
PB-AXISPRO-KPL450A	450				
PB-AXISPRO-KPL500A	500				
PB-AXISPRO-KPL550A	550		weiß blanc blanco		
PB-AXISPRO-KPL250A1	250				
PB-AXISPRO-KPL300A1	300				
PB-AXISPRO-KPL350A1	350				
PB-AXISPRO-KPL400A1	400				
PB-AXISPRO-KPL450A1	450				
PB-AXISPRO-KPL500A1	500				
PB-AXISPRO-KPL550A1	550				
PB-AXISPRO-KPL600A1	600				

## AXIS PRO

Schublade mittelhoch B  
Jeu de tiroir moyen B  
Juego cajón medio B

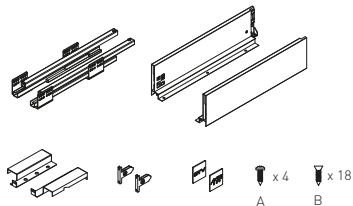

PB-AXISPRO-KPL250B	250	40	anthrazit anthracite antracita	lackiert peinture barnizado	Stahl acier acero
PB-AXISPRO-KPL300B	300				
PB-AXISPRO-KPL350B	350				
PB-AXISPRO-KPL400B	400				
PB-AXISPRO-KPL450B	450				
PB-AXISPRO-KPL500B	500				
PB-AXISPRO-KPL550B	550		weiß blanc blanco		
PB-AXISPRO-KPL600B	600				
PB-AXISPRO-KPL250B1	250				
PB-AXISPRO-KPL300B1	300				
PB-AXISPRO-KPL350B1	350				
PB-AXISPRO-KPL400B1	400				
PB-AXISPRO-KPL450B1	450				
PB-AXISPRO-KPL500B1	500				
PB-AXISPRO-KPL550B1	550				
PB-AXISPRO-KPL600B1	600				

## AXIS PRO

Schublade hoch C  
Jeu de tiroirs haut C  
Juego cajón alto C

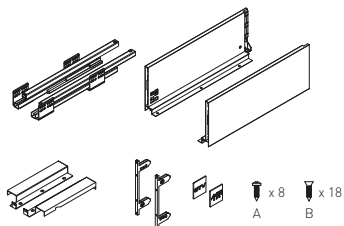

PB-AXISPRO-KPL250C	250	40	anthrazit anthracite antracita	lackiert peinture barnizado	Stahl acier acero
PB-AXISPRO-KPL300C	300				
PB-AXISPRO-KPL350C	350				
PB-AXISPRO-KPL400C	400				
PB-AXISPRO-KPL450C	450				
PB-AXISPRO-KPL500C	500				
PB-AXISPRO-KPL550C	550				
PB-AXISPRO-KPL600C	600				
PB-AXISPRO-KPL250C1	250				
PB-AXISPRO-KPL300C1	300				
PB-AXISPRO-KPL350C1	350	weiß blanc blanco			
PB-AXISPRO-KPL400C1	400				
PB-AXISPRO-KPL450C1	450				
PB-AXISPRO-KPL500C1	500				
PB-AXISPRO-KPL550C1	550				
PB-AXISPRO-KPL600C1	600				



## AXIS PRO

Schublade sehr hoch D  
Jeu de tiroirs très haut D  
Juego cajón muy alto D

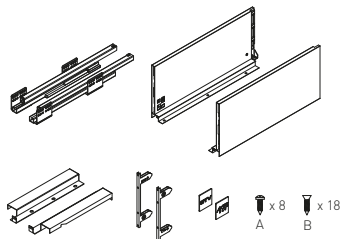

PB-AXISPRO-KPL250D	250	40	anthrazit anthracite antracita	lackiert peinture barnizado	Stahl acier acero
PB-AXISPRO-KPL300D	300				
PB-AXISPRO-KPL350D	350				
PB-AXISPRO-KPL400D	400				
PB-AXISPRO-KPL450D	450				
PB-AXISPRO-KPL500D	500				
PB-AXISPRO-KPL550D	550				
PB-AXISPRO-KPL600D	600				
PB-AXISPRO-KPL250D1	250				
PB-AXISPRO-KPL300D1	300				
PB-AXISPRO-KPL350D1	350	weiß blanc blanco			
PB-AXISPRO-KPL400D1	400				
PB-AXISPRO-KPL450D1	450				
PB-AXISPRO-KPL500D1	500				
PB-AXISPRO-KPL550D1	550				
PB-AXISPRO-KPL600D1	600				









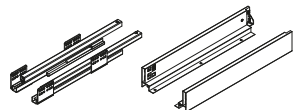



## AXIS PRO

Backofenschublade  
Kit tiroir sous-four  
Juego cajón muy bajo











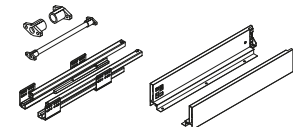

		 L mm	 kg ↓			
PB-AXISPRO-KPL69-450-60		450	40			
PB-AXISPRO-KPL69-500-60		500				
PB-AXISPRO-KPL69-450-10		450				
PB-AXISPRO-KPL69-500-10		500				
				anthrazit anthracite antracita	lackiert peinture barnizado	Stahl acier acero
				weiß blanc blanco		

## AXIS PRO PUSH TO OPEN

Schublade niedrig A  
Jeu de tiroir bas A  
Juego cajón bajo A

NEW



		 L mm	 kg ↓			
PB-AXISPRO-P20-KPL250A		250	40			
PB-AXISPRO-P20-KPL300A		300				
PB-AXISPRO-P20-KPL350A		350				
PB-AXISPRO-P20-KPL400A		400				
PB-AXISPRO-P20-KPL450A		450				
PB-AXISPRO-P20-KPL500A		500				
PB-AXISPRO-P20-KPL550A		550				
PB-AXISPRO-P20-KPL600A		600				
PB-AXISPRO-P20-KPL250A1		250				
PB-AXISPRO-P20-KPL300A1		300				
PB-AXISPRO-P20-KPL350A1		350				
PB-AXISPRO-P20-KPL400A1		400				
PB-AXISPRO-P20-KPL450A1		450				
PB-AXISPRO-P20-KPL500A1		500				
PB-AXISPRO-P20-KPL550A1		550				
PB-AXISPRO-P20-KPL600A1		600				
PB-AXISPRO-SYNCHRO-P20		1100	-	-	-	-
PB-AXISPRO-SYNCHRO-P20-MOC		-	-	-	-	-
				anthrazit anthracite antracita	lackiert peinture barni- zado	Stahl acier acero
				weiß blanc blanco		

## AXIS PRO PUSH TO OPEN

Schublade mittelhoch B  
Jeu de tiroir moyen B  
Juego cajón medio B

NEW

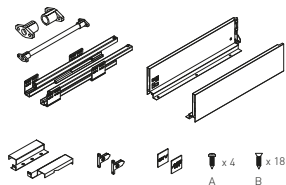

	L mm	kg			
PB-AXISPRO-P20-KPL250B	250	40	anthrazit anthracite antracita	lackiert peinture barni- zado	Stahl acier acero
PB-AXISPRO-P20-KPL300B	300				
PB-AXISPRO-P20-KPL350B	350				
PB-AXISPRO-P20-KPL400B	400				
PB-AXISPRO-P20-KPL450B	450				
PB-AXISPRO-P20-KPL500B	500				
PB-AXISPRO-P20-KPL550B	550		weiß blanc blanco		
PB-AXISPRO-P20-KPL600B	600				
PB-AXISPRO-P20-KPL250B1	250				
PB-AXISPRO-P20-KPL300B1	300				
PB-AXISPRO-P20-KPL350B1	350				
PB-AXISPRO-P20-KPL400B1	400				
PB-AXISPRO-P20-KPL450B1	450				
PB-AXISPRO-P20-KPL500B1	500				
PB-AXISPRO-P20-KPL550B1	550				
PB-AXISPRO-P20-KPL600B1	600				
PB-AXISPRO-SYNCHRO-P20	1100	-	-	-	-
PB-AXISPRO-SYNCHRO-P20-MOC	-	-	-	-	-

## AXIS PRO PUSH TO OPEN

Schublade hoch C  
Jeu de tiroirs haut C  
Juego cajón alto C

NEW

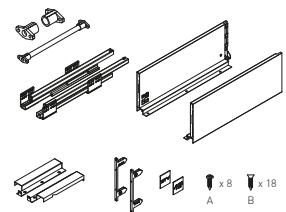

	L mm	kg			
PB-AXISPRO-P20-KPL250C	250	40	anthrazit anthracite antracita	lackiert peinture barni- zado	Stahl acier acero
PB-AXISPRO-P20-KPL300C	300				
PB-AXISPRO-P20-KPL350C	350				
PB-AXISPRO-P20-KPL400C	400				
PB-AXISPRO-P20-KPL450C	450				
PB-AXISPRO-P20-KPL500C	500				
PB-AXISPRO-P20-KPL550C	550		weiß blanc blanco		
PB-AXISPRO-P20-KPL600C	600				
PB-AXISPRO-P20-KPL250C1	250				
PB-AXISPRO-P20-KPL300C1	300				
PB-AXISPRO-P20-KPL350C1	350				
PB-AXISPRO-P20-KPL400C1	400				
PB-AXISPRO-P20-KPL450C1	450				
PB-AXISPRO-P20-KPL500C1	500				
PB-AXISPRO-P20-KPL550C1	550				
PB-AXISPRO-P20-KPL600C1	600				
PB-AXISPRO-SYNCHRO-P20	1100	-	-	-	-
PB-AXISPRO-SYNCHRO-P20-MOC	-	-	-	-	-

## AXIS PRO PUSH TO OPEN

Schublade sehr hoch D  
Jeu de tiroirs très haut D  
Juego cajón muy alto D

NEW

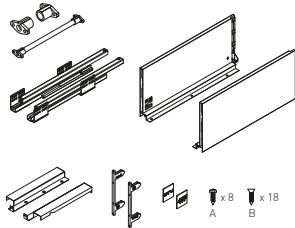

	L mm	kg			
PB-AXISPRO-P20-KPL250D	250	40			
PB-AXISPRO-P20-KPL300D	300				
PB-AXISPRO-P20-KPL350D	350				
PB-AXISPRO-P20-KPL400D	400				
PB-AXISPRO-P20-KPL450D	450				
PB-AXISPRO-P20-KPL500D	500				
PB-AXISPRO-P20-KPL550D	550				
PB-AXISPRO-P20-KPL600D	600				
PB-AXISPRO-P20-KPL250D1	250				
PB-AXISPRO-P20-KPL300D1	300				
PB-AXISPRO-P20-KPL350D1	350				
PB-AXISPRO-P20-KPL400D1	400				
PB-AXISPRO-P20-KPL450D1	450				
PB-AXISPRO-P20-KPL500D1	500				
PB-AXISPRO-P20-KPL550D1	550				
PB-AXISPRO-P20-KPL600D1	600				
PB-AXISPRO-SYNCHRO-P20	1100	-	-	-	-
PB-AXISPRO-SYNCHRO-P20-MOC	-	-	-	-	-





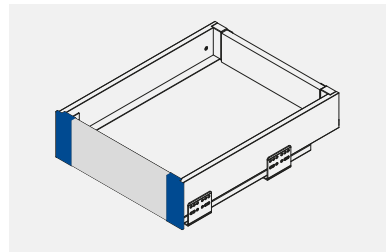

Innerer vorderer Stecker niedrig  
Connecteur avant intérieur bas  
Conector frontal interno bajo

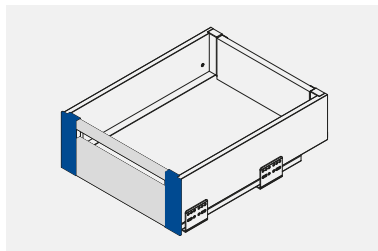

PB-AXISPRO-WEWMOCA			
PB-AXISPRO-WEWMOCA1			

Inneres vorderes Anschlussmedium  
Connecteur frontal intérieur moyen  
Conector frontal interno mediano



			
PB-AXISPRO-WEWMOCB		anthrazit anthracite antracita	Stahl acier acero
PB-AXISPRO-WEWMOCB1		weiß blanc blanco	

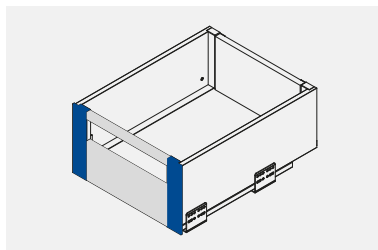

Innerer Frontstecker hoch  
Connecteur avant intérieur haut  
Conector frontal interno alto



			
PB-AXISPRO-WEWMOCC		anthrazit anthracite antracita	Stahl acier acero
PB-AXISPRO-WEWMOCC1		weiß blanc blanco	

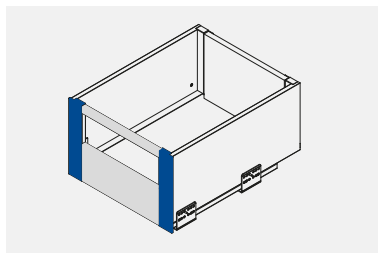



Innenfrontstecker sehr hoch  
Connecteur avant intérieur très haut  
Conector frontal interno muy alto

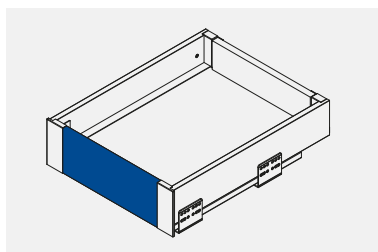
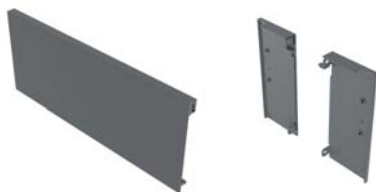

			
PB-AXISPRO-WEWM0CD		anthrazit anthracite antracita	Stahl acier acero
PB-AXISPRO-WEWM0CD1		weiß blanc blanco	





Niedriges Innenschubladen Set  
Jeu de tiroir intérieur bas  
Kit para cajón interior bajo

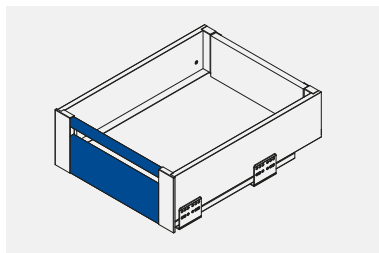

					
PB-AXISPRO-ZESWEW-A AXISPRO		110	1200	anthrazit anthracite antracita	Stahl acier acero
PB-AXISPRO-ZESWEW-A1 AXISPRO				weiß blanc blanco	





Mittelhohes Innenschubladen Set  
 Jeu de tiroir intérieur moyen  
 Kit para cajón interior mediano

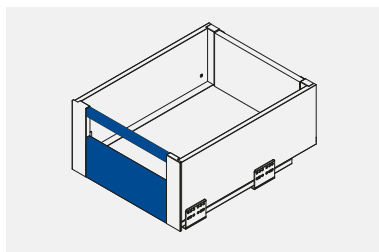
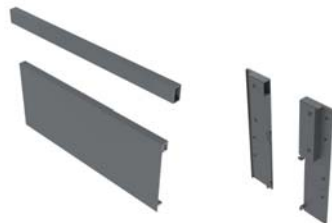

	 H mm	 L mm		
PB-AXISPRO-ZESWEW-B AXISPRO	95	1200	anthrazit anthracite antracita	Stahl acier acero
PB-AXISPRO-ZESWEW-B1 AXISPRO			weiß blanc blanco	

Sehr hohes Innenschubladen Set  
 Jeu de tiroir intérieur haut  
 Kit para cajón interior muy alto



	 H mm	 L mm		
PB-AXISPRO-ZESWEW-C AXISPRO	110	1200	anthrazit anthracite antracita	Stahl acier acero
PB-AXISPRO-ZESWEW-C1 AXISPRO			weiß blanc blanco	

Hohes Innenschubladen Set  
Jeu de tiroir intérieur très haut  
Kit para cajón interior alto

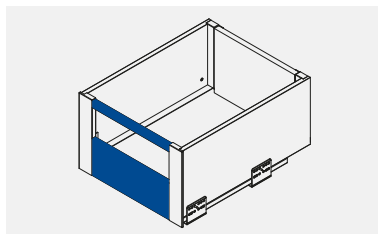
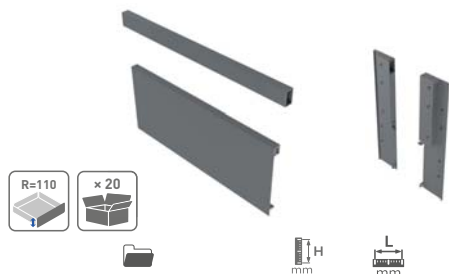

PB-AXISPRO-ZESWEW-D AXISPRO	110	1200	anthrazit / anthracite / antracita	Stahl acier acero
PB-AXISPRO-ZESWEW-D1 AXISPRO			weiß / blanc / blanco	

Quadratisches Längsgeländer  
Garde-corps longitudinal carré  
Barandilla cuadrada longitudinal

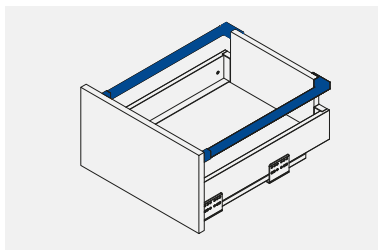

PB-AXISPRO-RELKW300	300	anthrazit anthracite antracita	Stahl acier acero	PB-AXISPRO-RELKW300-10	300	weiß blanc blanco	Stahl acier acero
PB-AXISPRO-RELKW350	350			PB-AXISPRO-RELKW350-10	350		
PB-AXISPRO-RELKW400	400			PB-AXISPRO-RELKW400-10	400		
PB-AXISPRO-RELKW450	450			PB-AXISPRO-RELKW450-10	450		
PB-AXISPRO-RELKW500	500			PB-AXISPRO-RELKW500-10	500		
PB-AXISPRO-RELKW550	550			PB-AXISPRO-RELKW550-10	550		

Marker für die Befestigung von AxisPro Fronten  
Marqueur pour installer les façades AxisPro  
Marcador para fijar frentes de AxisPro



PB-AXISPRO-ZNACZ-FRONT	Kunststoff plastique plástico
------------------------	-------------------------------------

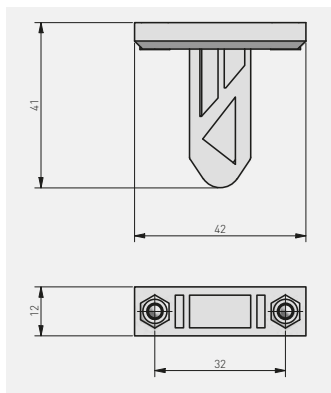

## Modern Box PRO

Schubladensystem  
Composition de l'ensemble  
Elementos del juego

LÄNGSREILING  
anthrazit / weiß  
L = 300-550 mm

RAIL LONGITUDINAL  
anthracite / blanc  
L = 300-550 mm

VARILLA LONGITUDINAL  
antracita / blanco  
L = 300-550 mm

Rückwandbefestigung  
Raccord de panneau arrière  
Conector del panel trasero

FRONTENBEFESTIGUNG + SCHRAUBEN  
FIXATION PANNEAU AVANT + VIS  
FIJACIÓN DEL FRENTE + TORNILLOS

ABDECKKAPPE  
FÜR EINSTELÖFFNUNGEN  
anthrazit / weiß  
BOUCHONS DES TROUS DE RÉGULATION  
anthracite / blanc  
TAPA DE ORIFICIOS DE AJUSTE  
antracita / blanco

FÜHRUNG  
L = 300-550 mm  
GLISSIÈRE  
L = 300-550 mm  
GUÍA  
L = 300-550 mm

ZARGE  
anthrazit / weiß  
L = 300-550 mm  
CÔTÉ DE TIROIR  
anthracite / blanc  
L = 300-550 mm  
PANEL LATERAL  
DEL CAJÓN  
antracita / blanco  
L = 300-550 mm





## Modern Box PRO

Schublade niedrig A

Jeu de tiroir bas A

Juego cajón bajo A

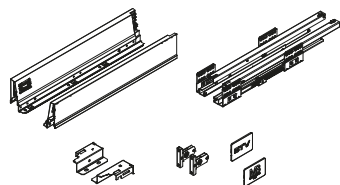

PB-MBPRO-KPL300A	300	40	anthrazit antracite antracita	lackiert peinture barnizado	Stahl acier acero
PB-MBPRO-KPL350A	350				
PB-MBPRO-KPL400A	400				
PB-MBPRO-KPL450A	450				
PB-MBPRO-KPL500A	500				
PB-MBPRO-KPL550A	550		weiß blanc blanco		
PB-MBPRO-KPL300A1	300				
PB-MBPRO-KPL350A1	350				
PB-MBPRO-KPL400A1	400				
PB-MBPRO-KPL450A1	450				
PB-MBPRO-KPL500A1	500				
PB-MBPRO-KPL550A1	550				



## Modern Box PRO

Schublade mittelhoch B

Jeu de tiroir moyen B

Juego cajón medio B

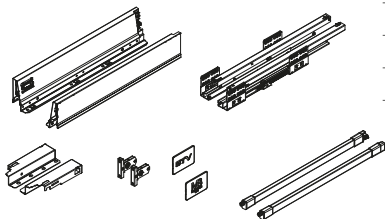







PB-MBPRO-KPL300B	300	40	anthrazit antracite antracita	lackiert peinture barnizado	Stahl acier acero
PB-MBPRO-KPL350B	350				
PB-MBPRO-KPL400B	400				
PB-MBPRO-KPL450B	450				
PB-MBPRO-KPL500B	500				
PB-MBPRO-KPL550B	550		weiß blanc blanco		
PB-MBPRO-KPL300B1	300				
PB-MBPRO-KPL350B1	350				
PB-MBPRO-KPL400B1	400				
PB-MBPRO-KPL450B1	450				
PB-MBPRO-KPL500B1	500				
PB-MBPRO-KPL550B1	550				

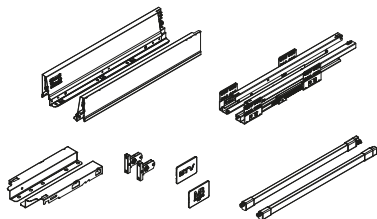

## Modern Box PRO

Schublade hoch C  
Jeu de tiroirs haut C  
Juego cajón alto C







						
PB-MBPRO-KPL300C		300				
PB-MBPRO-KPL350C		350				
PB-MBPRO-KPL400C		400				
PB-MBPRO-KPL450C		450				
PB-MBPRO-KPL500C		500				
PB-MBPRO-KPL550C		550				
PB-MBPRO-KPL300C1		300				
PB-MBPRO-KPL350C1		350				
PB-MBPRO-KPL400C1		400				
PB-MBPRO-KPL450C1		450				
PB-MBPRO-KPL500C1		500				
PB-MBPRO-KPL550C1		550				



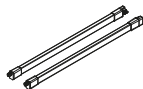

Option „D” - 167  
Option „D” - 167  
Opción „D” - 167



Komplementäre Produkte  
Produits connexes  
Productos relacionados





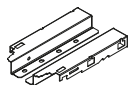

			
PB-MBPRO-KPL300A	PB-MBPRO-KPL300A1	300	
PB-MBPRO-KPL350A	PB-MBPRO-KPL350A1	350	
PB-MBPRO-KPL400A	PB-MBPRO-KPL400A1	400	
PB-MBPRO-KPL450A	PB-MBPRO-KPL450A1	450	
PB-MBPRO-KPL500A	PB-MBPRO-KPL500A1	500	
PB-MBPRO-KPL550A	PB-MBPRO-KPL550A1	550	
PB-MBPRO-RELKW300	PB-MBPRO-RELKW300-10	300	
PB-MBPRO-RELKW350	PB-MBPRO-RELKW350-10	350	
PB-MBPRO-RELKW400	PB-MBPRO-RELKW400-10	400	
PB-MBPRO-RELKW450	PB-MBPRO-RELKW450-10	450	
PB-MBPRO-RELKW500	PB-MBPRO-RELKW500-10	500	
PB-MBPRO-RELKW550	PB-MBPRO-RELKW550-10	550	

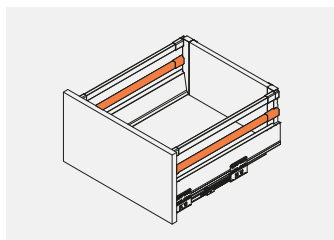

					
PB-MBPRO-ZLATYLD	D	anthrazit anthracite antracita	lackiert peinture barnizado	Stahl acier acero	
PB-MBPRO-ZLATYLD1		weiß blanc blanco			



Längsreiling  
Rail longitudinal  
Varilla longitudinal



	 mm	
PB-MBPRO-RELKW300	300	anthrazit anthracite antracita
PB-MBPRO-RELKW350	350	
PB-MBPRO-RELKW400	400	
PB-MBPRO-RELKW450	450	
PB-MBPRO-RELKW500	500	
PB-MBPRO-RELKW550	550	

	 mm	
PB-MBPRO-RELKW300-10	300	weiß blanc blanco
PB-MBPRO-RELKW350-10	350	
PB-MBPRO-RELKW400-10	400	
PB-MBPRO-RELKW450-10	450	
PB-MBPRO-RELKW500-10	500	
PB-MBPRO-RELKW550-10	550	



Innenfront-Verbinder, niedrig  
Raccord face avant intérieure, bas  
Conector del frente interior, bajo

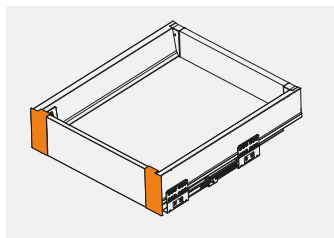

			
PB-MBPRO-WEWMOCA	Schublade niedrig A tiroir bas A cajón bajo A	anthrazit / anthracite / antracita	Kunststoff plastique plástico
PB-MBPRO-WEWMOCA1		weiß / blanc / blanco	



Inneres vorderes Anschlussmedium  
Connecteur frontal intérieur moyen  
Conector frontal interno mediano

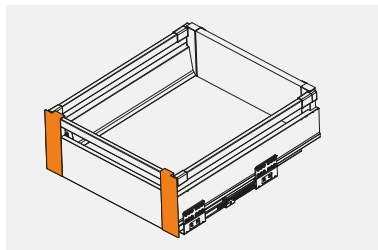

			
PB-MBPRO-WEWMOCB	anthrazit / anthracite / antracita	Stahl acier acero	
PB-MBPRO-WEWMOCB1	weiß / blanc / blanco		

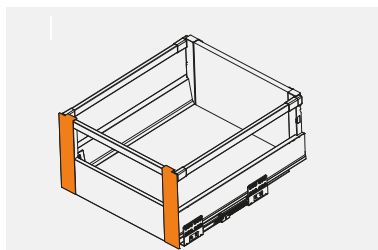

Innerer Frontstecker hoch  
Connecteur avant intérieur haut  
Conector frontal interno alto

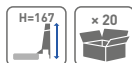
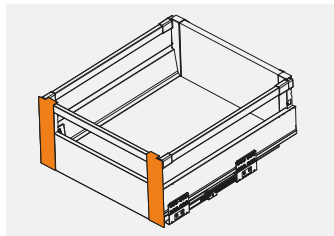

			
PB-MBPRO-WEWMOCC	anthrazit / anthracite / antracita	Stahl acier acero	
PB-MBPRO-WEWMOCC1	weiß / blanc / blanco		

Frontverbinder 167 „D“  
Connecteur frontal 167 „D“  
Conector del frente 167 „D“



			
PB-MBPRO-WEWMOCD	anthrazit / anthracite / antracita	Stahl acier acero	
PB-MBPRO-WEWMOCD1	weiß / blanc / blanco		

Rückwandbefestigung, niedrig  
Raccord de panneau arrière, bas  
Conector del panel trasero, bajo

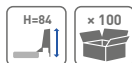
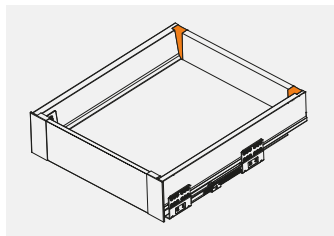

			
PB-MBPRO-ZLATYLA	anthrazit / anthracite / antracita	Stahl acier acero	
PB-MBPRO-ZLATYLA1	weiß / blanc / blanco		

Rückwandbefestigung, niedrig  
 Raccord de panneau arrière, milieu  
 Conector para panel trasero, medio

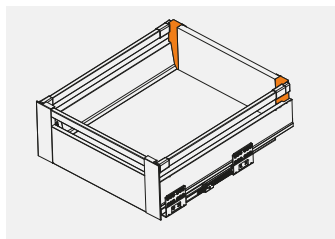

PB-MBPRO-ZLATYLB	anthrazit / anthracite / antracita	Stahl acier acero
PB-MBPRO-ZLATYLB1	weiß / blanc / blanco	

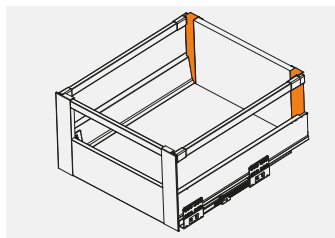

Rückwandbefestigung, hoch  
 Connecteur de panneau arrière, haut  
 Conector del panel trasero, alto



PB-MBPRO-ZLATYLC	anthrazit / anthracite / antracita	Stahl acier acero
PB-MBPRO-ZLATYLC1	weiß / blanc / blanco	

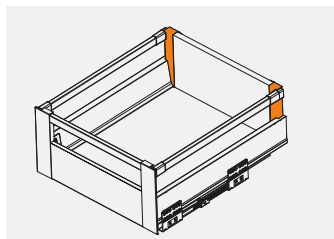

Rückwandbefestigung, hoch  
Connecteur de panneau arrière, haut  
Conector del panel trasero, alto

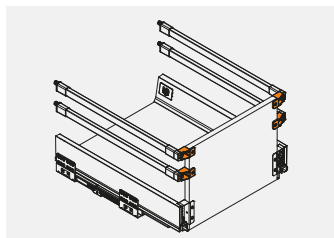

			
PB-MBPRO-ZLATYLD		anthrazit / anthracite / antracita	Stahl acier acero
PB-MBPRO-ZLATYLD1		weiß / blanc / blanco	

Befestigung der Relings an erhöhte Rückwand  
Fixation du rail à la paroi arrière surélevée  
Fijación de la varilla al panel trasero elevado



			
PB-MBPRO-MOCRELYL		anthrazit / anthracite / antracita	Stahl acier acero
PB-MBPRO-MOCRELYL1		weiß / blanc / blanco	

Innenschubladen-Organisations-Set H=84  
 Kit d'aménagement de tiroir intérieur H=84  
 Juego de divisores para el cajón interior H=84

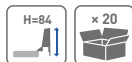
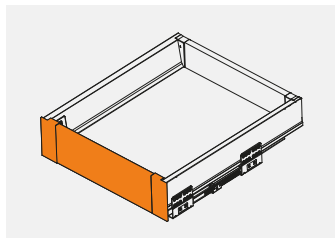

PB-MBPRO-ZESWEW-A	anthrazit / anthracite / antracita	Kunststoff plastique plástico
PB-MBPRO-ZESWEW-A1	weiß / blanc / blanco	

Innenschubladen-Organisations-Set H=135  
 Kit d'aménagement de tiroir intérieur H=135  
 Juego de divisores para el cajón interior H=135

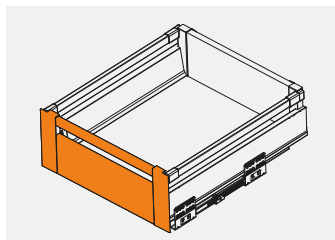



PB-MBPRO-ZESWEW-B	anthrazit / anthracite / antracita	Kunststoff plastique plástico
PB-MBPRO-ZESWEW-B1	weiß / blanc / blanco	

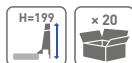
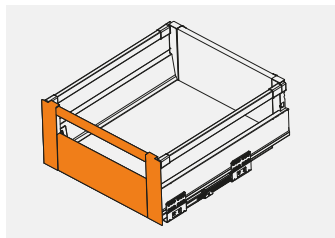

Innenschubladen-Organisations-Set H=199  
 Kit d'aménagement de tiroir intérieur H=199  
 Juego de divisores para el cajón interior H=199



		
PB-MBPRO-ZESWEW-C	anthrazit / anthracite / antracita	Kunststoff plastique plástico
PB-MBPRO-ZESWEW-C1	weiß / blanc / blanco	

Innenschubladen-Organisations-Set H=167  
 Kit d'aménagement de tiroir intérieur H=167  
 Juego de divisores para el cajón interior H=167

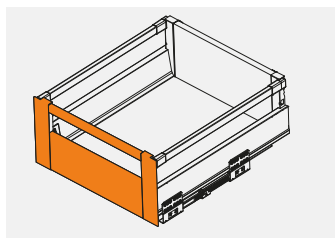

		
PB-MBPRO-ZESWEW-D	anthrazit / anthracite / antracita	Kunststoff plastique plástico
PB-MBPRO-ZESWEW-D1	weiß / blanc / blanco	

## Modern Box Square

Schubladensystem

Composition de l'ensemble

Elementos del juego

### RÜCKWANDBEFESTIGUNG

niedrig / mittelhoch / hoch  
grau / weiß

### FIXATION DE PANNEAU ARRIÈRE

bas / moyen / haut  
gris / blanc

### FIJACIÓN DEL PANEL

bajo / medio / alto  
gris / blanco

### LÄNGSREILING

grau / weiß  
L = 250-550 mm

### RAIL LONGITUDINAL

gris / blanc  
L = 250-550 mm

### VARILLA LONGITUDINAL

gris / blanco  
L = 250-550 mm

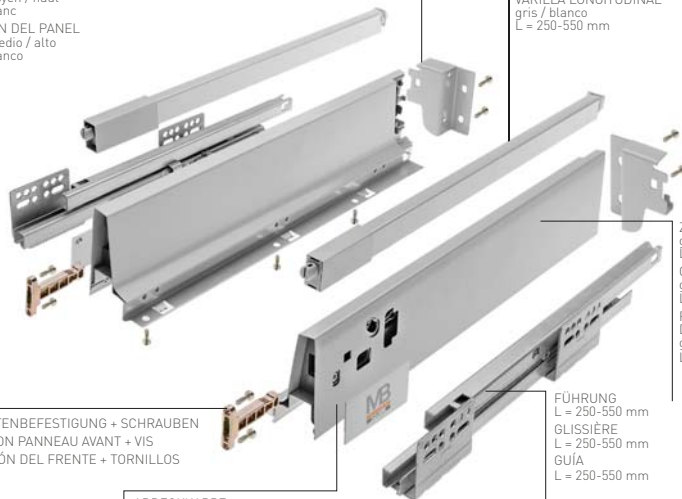

### ZARGE

grau / weiß  
L = 250-550 mm

### CÔTÉ DE TIROIR

gris / blanc  
L = 250-550 mm

### PANEL LATERAL

gris / blanco  
L = 250-550 mm

### FRONTENBEFESTIGUNG + SCHRAUBEN

FIXATION PANNEAU AVANT + VIS  
FIJACIÓN DEL FRENTE + TORNILLOS

### FÜHRUNG

L = 250-550 mm

### GLISSIÈRE

L = 250-550 mm

### GUÍA

L = 250-550 mm

### ABDECKKAPPE

FÜR EINSTELLÖFFNUNGEN

grau / weiß

BOUCHONS DES TROUS DE RÉGULATION

gris / blanc

TAPA DE ORIFICIOS DE AJUSTE

gris / blanco







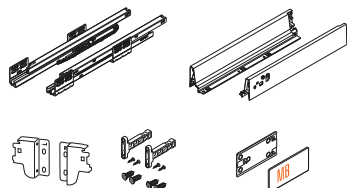

## Modern Box Square

Schublade niedrig A

Jeu de tiroir bas A

Juego cajón bajo A



						
PB-KW-KPL250A	250	40	graub gris, gris	lackiert peinture barnizado	Stahl acier acero	
PB-KW-KPL300A	300					
PB-KW-KPL350A	350					
PB-KW-KPL400A	400					
PB-KW-KPL450A	450					
PB-KW-KPL500A	500					
PB-KW-KPL550A	550					
PB-KW-KPL600A	600					
PB-KW-KPL250A1	250					
PB-KW-KPL300A1	300					
PB-KW-KPL350A1	350					
PB-KW-KPL400A1	400					
PB-KW-KPL450A1	450					
PB-KW-KPL500A1	500					
PB-KW-KPL550A1	550					
PB-KW-KPL600A1	600					





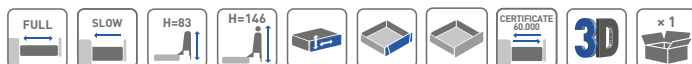
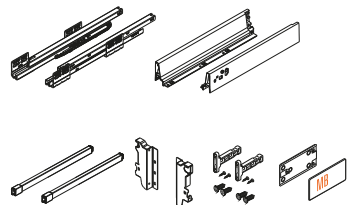

## Modern Box Square

Schublade mittelhoch B

Jeu de tiroir moyen B

Juego cajón medio B



						
PB-KW-KPL250B	250	40	graub gris, gris	lackiert peinture barnizado	Stahl acier acero	
PB-KW-KPL300B	300					
PB-KW-KPL350B	350					
PB-KW-KPL400B	400					
PB-KW-KPL450B	450					
PB-KW-KPL500B	500					
PB-KW-KPL550B	550					
PB-KW-KPL600B	600					
PB-KW-KPL250B1	250					
PB-KW-KPL300B1	300					
PB-KW-KPL350B1	350					
PB-KW-KPL400B1	400					
PB-KW-KPL450B1	450					
PB-KW-KPL500B1	500					
PB-KW-KPL550B1	550					
PB-KW-KPL600B1	600					

## Modern Box Square

Schublade hoch C  
Jeu de tiroirs haut C  
Juego cajón alto C

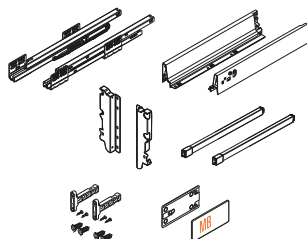

	L mm	kg			
PB-KW-KPL250C	250	40	grau gris, gris	lackiert peinture barnizado	Stahl acier acero
PB-KW-KPL300C	300				
PB-KW-KPL350C	350				
PB-KW-KPL400C	400				
PB-KW-KPL450C	450				
PB-KW-KPL500C	500				
PB-KW-KPL550C	550		weiß blanc blanco		
PB-KW-KPL600C	600				
PB-KW-KPL250C1	250				
PB-KW-KPL300C1	300				
PB-KW-KPL350C1	350				
PB-KW-KPL400C1	400				
PB-KW-KPL450C1	450				
PB-KW-KPL500C1	500				
PB-KW-KPL550C1	550				
PB-KW-KPL600C1	600				



## Längsreiling Rail longitudinal Varilla longitudinal

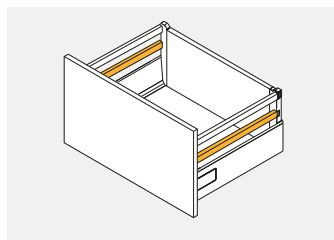

	L mm			
PB-D-RELKW350	350	grau gris, gris	lackiert peinture barnizado	Stahl acier acero
PB-D-RELKW400	400			
PB-D-RELKW450	450			
PB-D-RELKW500	500			
PB-D-RELKW550	550			

	L mm			
PB-D-RELKW350-10	350	weiß blanc blanco	lackiert peinture barnizado	Stahl acier acero
PB-D-RELKW400-10	400			
PB-D-RELKW450-10	450			
PB-D-RELKW500-10	500			
PB-D-RELKW550-10	550			



Innenfront-Verbinder, niedrig  
Raccord face avant intérieure, bas  
Conector del frente interior, bajo

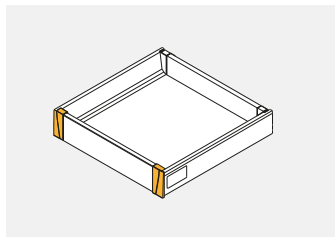

PB-D-WEWMOCA-KW	Schublade niedrig A tiroir bas A cajón bajo A	grau / gris / gris	Kunststoff plastique plástico
PB-D-WEWMOCA-KW-10		weiß / blanc / blanco	



Innenfront-Verbinder, mittelhoch  
Connecteur avant intérieur, moyen  
Conector del frente interior, medio

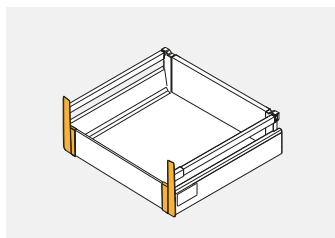

PB-D-WEWMOCB-KW	Schublade mittelhoch B tiroir moyen B cajón medio B	grau / gris / gris	Kunststoff plastique plástico
PB-D-WEWMOCB-KW-10		weiß / blanc / blanco	



Innenfront-Verbinder, hoch  
Raccord intérieur face avant, haut  
Conector del frente interior, alto

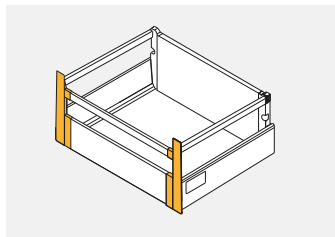

PB-D-WEWMOCC-KW	Schublade hoch C tiroir haut C cajón alto C	grau / gris / gris	Kunststoff plastique plástico
PB-D-WEWMOCC-KW-10		weiß / blanc / blanco	



Sehr hohes Innenschubladen Set Modern Box Square  
Jeu de tiroir intérieur haut Modern Box Square  
Kit para cajón interior muy alto Modern Box Square

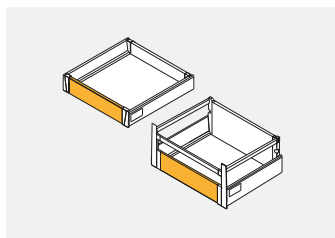





PB-D-ZESWEWKW-C	1100	grau / gris / gris	Aluminium, aluminium, aluminio
PB-D-ZESWEWKW-C-10		weiß / blanc / blanco	

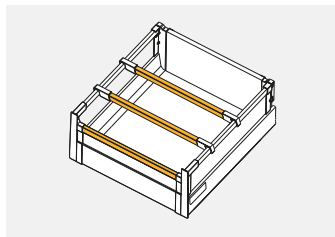

Innenschubladen-Organisations-Set Modern Box Square  
 Kit d'aménagement de tiroir intérieur Modern Box Square  
 Juego de divisores para el cajón interior Modern Box Square





	 mm		
PB-D-WEWORGKW-A	1100	grau / gris / gris	Stahl acier acero
PB-D-WEWORGKW-A-10		weiß / blanc / blanco	

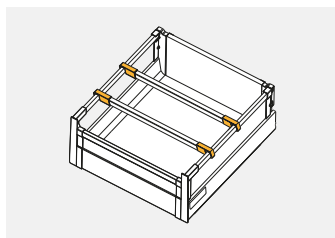

Verbinder für Querreling  
 Raccord pour rails transversaux  
 Conector varilla transversal



			
PB-D-ZR-KW-00	1 Set = 2 Stk. 1 ensemble = 2 pc 1 jgo. = 2 uds.	grau / gris / gris	Kunststoff plastique plástico
PB-D-ZR-KW-10		weiß / blanc / blanco	



Innenschubladen-Organisations-Set  
 Kit d'aménagement de tiroir intérieur  
 Juego de divisores para el cajón interior

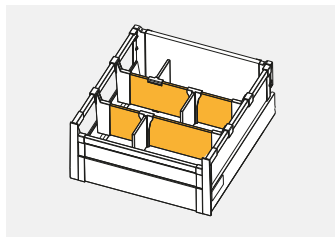





	 mm		
PB-D-WEWORGKW-B	1100	grau / gris / gris	Aluminium, aluminium, aluminio
PB-D-WEWORGKW-B-10		weiß / blanc / blanco	

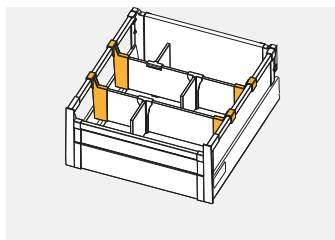

Verbinder für Querleiste  
 Raccord sur la bande transversale  
 Conector para división transversal



			
PB-D-CONREL-KW	1 Set = 2 Stk. 1 ensemble = 2 pc 1 jgo. = 2 uds.	grau / gris / gris	Kunststoff plastique plástico
PB-D-CONREL-KW-10		weiß / blanc / blanco	





Trennung für Querleiste  
 Séparateur de bandes transversales  
 Separador longitudinal para varilla transversal

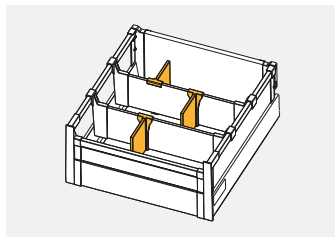

PB-D-PRZEGLP-KW	1 Stück 1 pc 1 uds.	grau / gris / gris	Kunststoff plastique plástico
PB-D-PRZEGLP-KW-10		weiß / blanc / blanco	



Befestigung der Relings an erhöhte Rückwand  
 Fixation du rail à la paroi arrière surélevée  
 Fijación de la varilla al panel trasero elevado

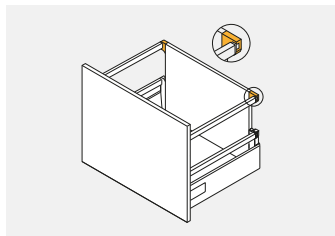





PB-D-D2R0-00	1 Set = 2 Stk. 1 ensemble = 2 pc 1 jgo. = 2 uds.	grau / gris / gris	Kunststoff plastique plástico
PB-D-D2R0-01		weiß / blanc / blanco	

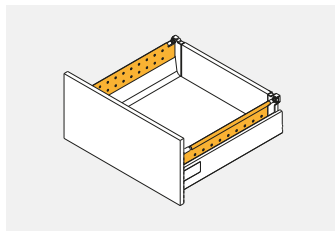
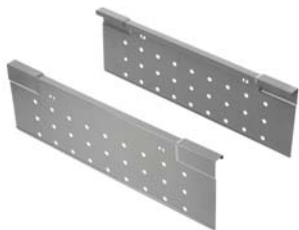

Lochseitenwand für mittelhohe Schublade  
 Cote perforé pour tiroir moyen  
 Panel lateral perforado para cajón medio



	 L mm		
PB-D-BXSIDEKW25C	250	grau gris, gris	Stahl acier acero
PB-D-BXSIDEKW30C	300		
PB-D-BXSIDEKW35C	350		
PB-D-BXSIDEKW40C	400		
PB-D-BXSIDEKW45C	450		
PB-D-BXSIDEKW50C	500		
PB-D-BXSIDEKW55C	550		
PB-D-BXSIDEKW25C-10	250	weiß blanc blanco	
PB-D-BXSIDEKW30C-10	300		
PB-D-BXSIDEKW35C-10	350		
PB-D-BXSIDEKW40C-10	400		
PB-D-BXSIDEKW45C-10	450		
PB-D-BXSIDEKW50C-10	500		
PB-D-BXSIDEKW55C-10	550		



Rückwandbefestigung, niedrig  
Raccord de panneau arrière, bas  
Conector del panel trasero, bajo

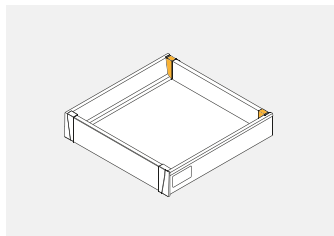

PB-D-N2R0-00	1 Set = L+R 1 ensemble = G+D 1 jgo. = I+D	grau / gris / gris	Stahl acier acero
PB-D-N2R0-01		weiß / blanc / blanco	



Rückwandbefestigung, niedrig  
Raccord de panneau arrière, milieu  
Conector para panel trasero, medio

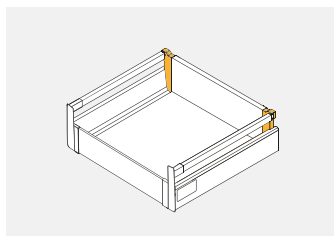

PB-D-S2R0-00	1 Set = L+R 1 ensemble = G+D 1 jgo. = I+D	grau / gris / gris	Stahl acier acero
PB-D-S2R0-01		weiß / blanc / blanco	



Rückwandbefestigung, hoch  
Connecteur de panneau arrière, haut  
Conector del panel trasero, alto

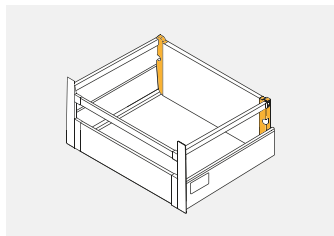

PB-D-W2R0-00	1 Set = L+R 1 ensemble = G+D 1 jgo. = I+D	grau / gris / gris	Stahl acier acero
PB-D-W2R0-01		weiß / blanc / blanco	



Relingbefestigung  
Fixation aux rails  
Soporte para varillas



PB-D-MHG04-KW	1 Stück 1 pc. 1 uds.	grau gris, gris	Kunststoff plastique plástico
---------------	----------------------------	-----------------------	-------------------------------------



Schablone für Relingmontage  
Matrice de rails  
Matriz para varillas



			
PB-D-MATRYCA	1 Set = 2 Stk. 1 ensemble = 2 pc 1 jgo. = 2 uds.	grau gris, gris	Kunststoff plastique plástico



Markierung für Frontenbefestigung  
Marqueur de face avant  
Marcador para frentes



			
PB-D-ZNACZ-0	1 Set = 2 Stk. 1 ensemble = 2 pc 1 jgo. = 2 uds.	grau gris, gris	ZnAl



## Modern Box

Schubladensystem  
Composition de l'ensemble  
Elementos del juego

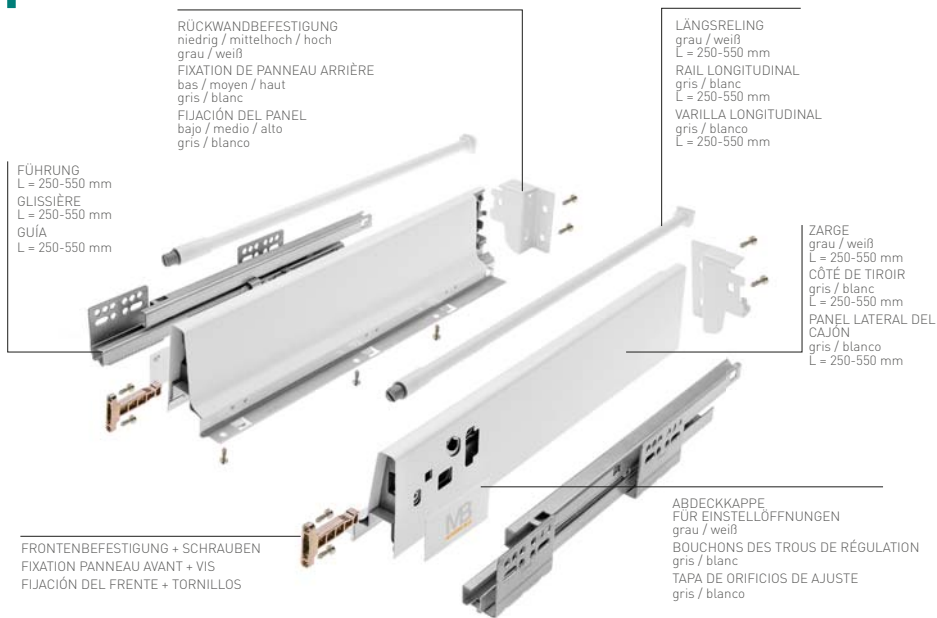

## Modern Box

Schublade niedrig A  
Jeu de tiroir bas A  
Juego cajón bajo A

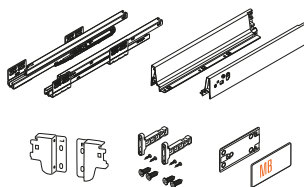

PB-D-KPL250A	250	soft close	40	40	grau gris, gris	lackiert peinture barnizado	Stahl acier acero
PB-D-KPL300A	300						
PB-D-KPL350A	350						
PB-D-KPL400A	400						
PB-D-KPL450A	450						
PB-D-KPL500A	500						
PB-D-KPL550A	550						
PB-D-KPL250A1	250						
PB-D-KPL300A1	300						
PB-D-KPL350A1	350						
PB-D-KPL400A1	400						
PB-D-KPL450A1	450						
PB-D-KPL500A1	500						
PB-D-KPL550A1	550						
PB-D-P20250A	250	push to open	40	40	grau gris, gris	lackiert peinture barnizado	Stahl acier acero
PB-D-P20300A	300						
PB-D-P20350A	350						
PB-D-P20400A	400						
PB-D-P20450A	450						
PB-D-P20500A	500						



### Modern Box

Schublade mittelhoch B  
Jeu de tiroir moyen B  
Juego cajón medio B

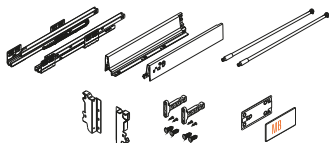

PB-D-KPL250B	250	soft close	40	grau gris, gris	lackiert peinture barnizado	Stahl acier acero
PB-D-KPL300B	300					
PB-D-KPL350B	350					
PB-D-KPL400B	400					
PB-D-KPL450B	450					
PB-D-KPL500B	500					
PB-D-KPL550B	550					
PB-D-KPL250B1	250					
PB-D-KPL300B1	300					
PB-D-KPL350B1	350					
PB-D-KPL400B1	400					
PB-D-KPL450B1	450					
PB-D-KPL500B1	500					
PB-D-KPL550B1	550					

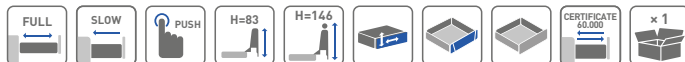

### Modern Box

Schublade hoch C  
Jeu de tiroirs haut C  
Juego cajón alto C

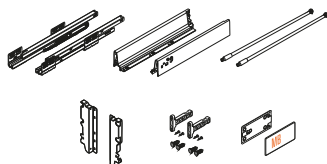





PB-D-KPL250C	250	soft close	40	grau gris, gris	lackiert peinture barnizado	Stahl acier acero
PB-D-KPL300C	300					
PB-D-KPL350C	350					
PB-D-KPL400C	400					
PB-D-KPL450C	450					
PB-D-KPL500C	500					
PB-D-KPL550C	550					
PB-D-KPL250C1	250					
PB-D-KPL300C1	300					
PB-D-KPL350C1	350					
PB-D-KPL400C1	400					
PB-D-KPL450C1	450					
PB-D-KPL500C1	500					
PB-D-KPL550C1	550					
PB-D-P20300C	300					
PB-D-P20350C	350					
PB-D-P20400C	400					
PB-D-P20450C	450					
PB-D-P20500C	500					
PB-D-P20550C	550					



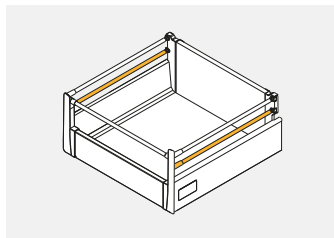





Längsreiling  
Rail longitudinal  
Varilla longitudinal







	 L mm		
PB-D-REL2500	250	grau gris, gris	Stahl acier acero
PB-D-REL3000	300		
PB-D-REL3500	350		
PB-D-REL4000	400		
PB-D-REL4500	450		
PB-D-REL5000	500		
PB-D-REL5500	550		

	 L mm		
PB-D-REL450-10	450	weiß blanc blanco	Stahl acier acero
PB-D-REL500-10	500		
PB-D-REL550-10	550		

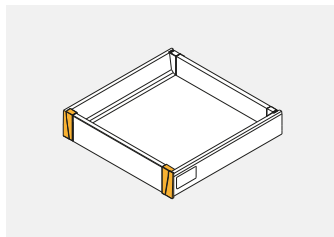

Innenfront-Verbinder, niedrig  
Raccord face avant intérieure, bas  
Conector del frente interior, bajo



			
PB-D-WEWMOCA	Schublade niedrig A tiroir bas A cajón bajo A	grau / gris / gris	Kunststoff plastique plástico
PB-D-WEWMOCA1		weiß / blanc / blanco	



Innenfront-Verbinder, mittelhoch  
 Connecteur avant intérieur, moyen  
 Conector del frente interior, medio

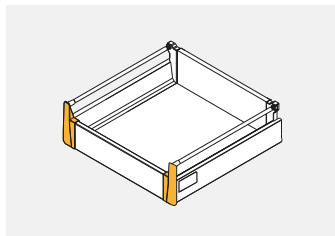

PB-D-WEWMOCB	Schublade mittelhoch B tiror moyen B cajón medio B	grau / gris / gris	Kunststoff plastique plástico
PB-D-WEWMOCB1		weiß / blanc / blanco	



Innenfront-Verbinder, hoch, für 1 Relingset  
 Raccord de face avant intérieur, haut, jusqu'à 1 jeu de rails  
 Conector del frente interior, alto, para 1 juego de carriles

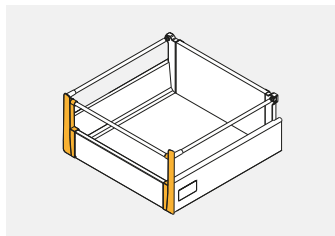

PB-D-WEWSZKLC	Schublade hoch C, 1 Reling tiror haut C, 1 rail cajón alto C, 1 carril	grau / gris / gris	Kunststoff plastique plástico
PB-D-WEWSZKLC-10		weiß / blanc / blanco	



Innenfront-Verbinder, hoch, für 2 Relingsets  
 Raccord de face avant intérieur, haut, jusqu'à 2 jeu de rails  
 Conector del frente interior, alto, para 2 juegos de carriles

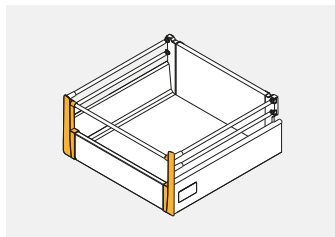

PB-D-WEWMOCC	Schublade hoch C, 2 Relings tiroir haut C, 2 rails cajón alto C, 2 carriles	grau / gris / gris	Kunststoff plastique plástico
PB-D-WEWMOCC1		weiß / blanc / blanco	



Sehr hohes Innenschublade Set  
 Jeu de tiroir intérieur haut  
 Kit para cajón interior muy alto

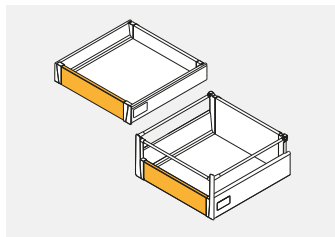

PB-D-ZESWEW-C	1100	grau / gris / gris	Aluminium, aluminium, aluminio
PB-D-ZESWEW-C-10		weiß / blanc / blanco	



Innenschubladen-Organisations-Set  
 Kit d'aménagement de tiroir intérieur  
 Juego de divisores para el cajón interior

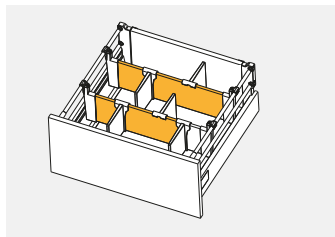

PB-D-WEWORG-A	1100	grau / gris / gris	Aluminium, aluminium, aluminio
PB-D-WEWORG-A-10		weiß / blanc / blanco	
PB-D-WEWORG-B		grau / gris / gris	
PB-D-WEWORG-B-10		weiß / blanc / blanco	



Verbinder für Querreling  
 Raccord pour rail transversal  
 Conector del carril transversal

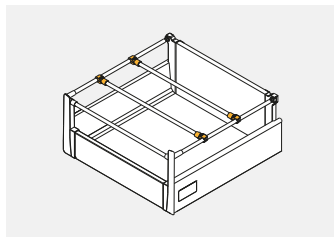

			
PB-D-ZR-00-0	1 Set = 2 Stk. 1 ensemble = 2 pc 1 jgo. = 2 uds.	grau / gris / gris	Kunststoff plastique plástico
PB-D-ZR-00-10		weiß / blanc / blanco	



Griff für Innenschublade  
 Poignée pour tiroir à l'anglaise  
 Tirador interior para cajón

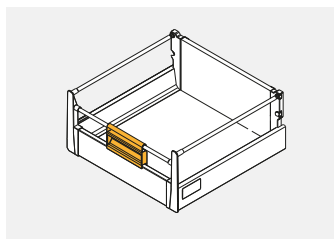

		
PB-D-UCHWEW	grau / gris / gris	Kunststoff plastique plástico
PB-D-UCHWEW-10	weiß / blanc / blanco	



Kreuzverbinder für Reling  
 Raccord transversal pour rail  
 Conector de cruz para varillas

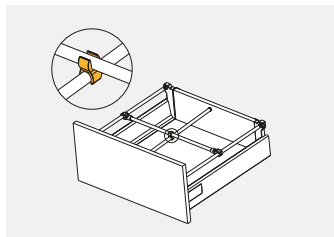

		
PB-D-LR-00-0	grau / gris / gris	Kunststoff plastique plástico
PB-D-LR-00-10	weiß / blanc / blanco	



Endkappe für Querreling  
 Embout d'extrémité pour rail transversal  
 Tapa para varilla transversal

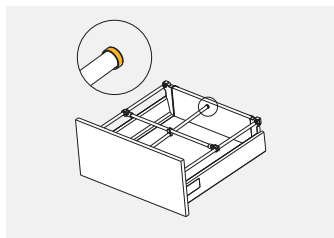

		
PB-D-RELCOV	grau / gris / gris	Kunststoff plastique plástico
PB-D-RELCOV-10	weiß / blanc / blanco	



Verbinder für Querleiste, Montage an Reling  
 Connecteur de barres transversales pour rail  
 Conector para panel transversal

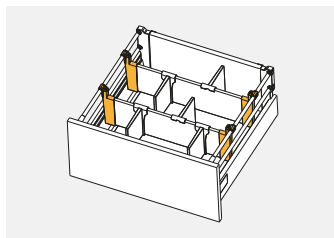

PB-D-CONREL	1 Set = 2 Stk. 1 ensemble = 2 pc 1 jgo. = 2 uds.	grau / gris / gris	Kunststoff plastique plástico
PB-D-CONREL-10		weiß / blanc / blanco	



Verbinder für Querleiste, Montage an Lochseitenwand  
 Raccord de barre transversale pour côté perforé  
 Conector barra transversal para panel lateral perforado

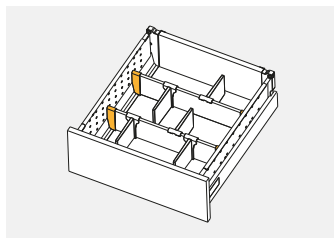

PB-D-CONBXSID	1 Set = 2 Stk. 1 ensemble = 2 pc 1 jgo. = 2 uds.	grau / gris / gris	Kunststoff plastique plástico
PB-D-CONBXSIDE-10		weiß / blanc / blanco	



Trennung für Querleiste  
 Séparateur de barres transversales  
 Separador longitudinal

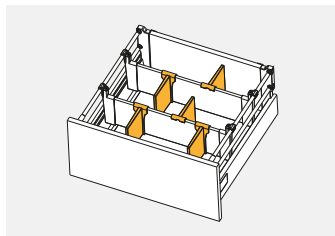

PB-D-PRZEGLP	grau / gris / gris	Kunststoff plastique plástico
PB-D-PRZEGLP-10	weiß / blanc / blanco	



Lochseitenwand für mittelhohe Schublade  
 Côté perforé pour tiroir moyen  
 Panel lateral perforado para cajón medio

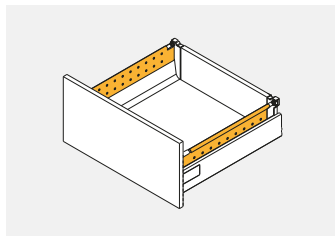





PB-D-BXSIDE45B	450	grau / gris / gris	Stahl acier acero
PB-D-BXSIDE45B-10		weiß / blanc / blanco	
PB-D-BXSIDE50B	500	grau / gris / gris	
PB-D-BXSIDE50B-10		weiß / blanc / blanco	



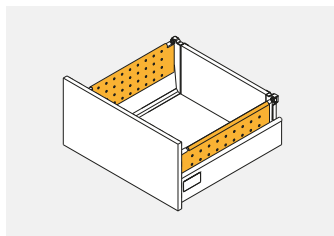
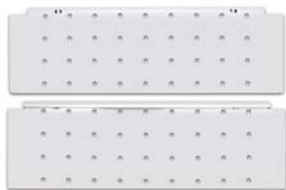

Lochseitenwand für hohe Schublade  
 Côté perforé pour tiroir haut  
 Panel lateral perforado para cajón alto







	 L mm		
PB-D-BXSIDE45C	450	grau / gris / gris	Stahl acier acero
PB-D-BXSIDE45C-10		weiß / blanc / blanco	
PB-D-BXSIDE50C	500	grau / gris / gris	
PB-D-BXSIDE50C-10		weiß / blanc / blanco	

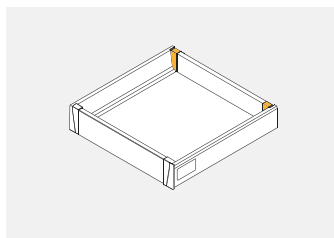

Rückwandbefestigung, niedrig  
 Raccord de panneau arrière, bas  
 Conector panel trasero, bajo







			
PB-D-N2R0-00	1 Set = L+R 1 ensemble = G+D 1 jgo. = I+D	grau / gris / gris	Stahl acier acero
PB-D-N2R0-01		weiß / blanc / blanco	

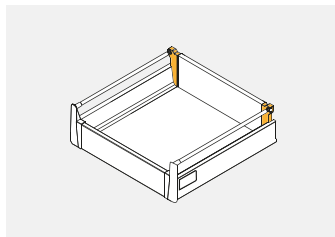

Rückwandbefestigung, mittelhoeh  
 Raccord de panneau arrière, milieu  
 Conector panel trasero, medio







			
PB-D-S2R0-00	1 Set = L+R 1 ensemble = G+D 1 jgo. = l+D	grau / gris / gris	Stahl acier acero
PB-D-S2R0-01		weiß / blanc / blanco	

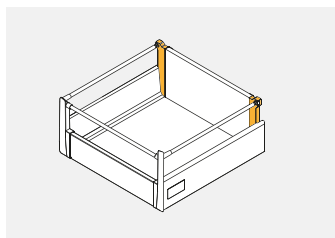

Rückwandbefestigung, hoch  
 Raccord de panneau arrière, haut  
 Conector panel trasero, alto







			
PB-D-W2R0-00	1 Set = L+R 1 ensemble = G+D 1 jgo. = l+D	grau / gris / gris	Stahl acier acero
PB-D-W2R0-01		weiß / blanc / blanco	

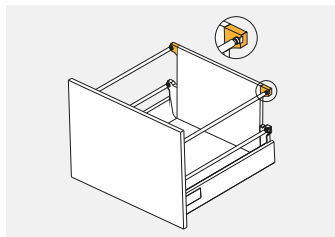

Befestigung der Relings an erhöhte Rückwand  
 Fixation de rail sur le panneau arrière surélevé  
 Fijación de la varilla al panel trasero alto







			
PB-D-D2R0-00	1 Set = 2 Stk. 1 ensemble = 2 pc 1 jgo. = 2 uds.	grau / gris / gris	Kunststoff plastique plástico
PB-D-D2R0-01		weiß / blanc / blanco	



Schablone für Relingmontage  
 Matrice de rails  
 Matriz para carriles







			
PB-D-MATRYCA	1 Set = 2 Stk. 1 ensemble = 2 pc 1 jgo. = 2 uds.	grau / gris / gris	Kunststoff plastique plástico



Markierung für Frontenbefestigung  
 Marqueur de face avant  
 Marcador para frentes







			
PB-D-ZNACZ-0	1 Set = 2 Stk. 1 ensemble = 2 pc 1 jgo. = 2 uds.	grau, gris, gris	ZnAl



Befestigung für Relings  
 Fixation aux rails  
 Soporte para varillas







			
PB-D-MHG04	1 Set = 2 Stk. 1 ensemble = 2 pc 1 jgo. = 2 uds.	grau / gris / gris	Kunststoff plastique plástico

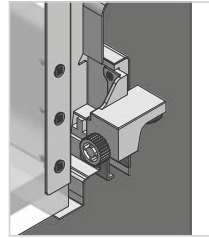

Stabilisierungsrolle für Push-to-Open-Schubladen  
 Rouleau stabilisateur pour tiroirs à ouverture rapide  
 Rodillo estabilizador para cajones push to open









			
PB-D-MBSTAB-00	1 Set = L+R 1 ensemble = G+D 1 jgo. = I+D	grau, gris, gris	Kunststoff plastique plástico

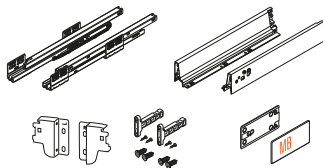

## Modern Box

Niedrige Backofenschublade  
 Jeu de tiroir de four bas  
 Juego cajón bajo para horno



					
PB-D-KPL68-450-80	450	40	grau, gris, gris	lackiert peinture barnizado	Stahl acier acero
PB-D-KPL68-500-80	500				
PB-D-KPL68-450-10	450		weiß blanc blanco		
PB-D-KPL68-500-10	500				



## Modern Box

Schublade montiert unter Spüle, niedrig  
 Jeu de tiroirs d'évier de cuisine  
 Juego cajón para fregadero bajo



PB-D-ZLE-450	450	40	grau, gris, gris	lackiert peinture barnizado	Stahl acier acero
PB-D-ZLE-500	500				

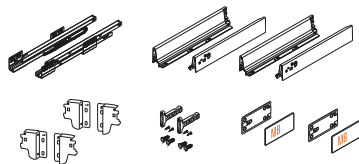

## Modern Box

Schublade montiert unter Spüle, U-förmig, niedrig  
 Set de tiroir d'évier en forme U  
 Juego cajón bajo fregadero en forma de U, bajo



PB-D-ULE-500	500	40	grau, gris, gris	lackiert peinture barnizado	Stahl acier acero
--------------	-----	----	---------------------	-----------------------------------	-------------------------

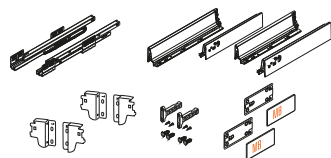



Bohrlochschablone für die Schubladen AXIS PRO und MODERN BOX PRO  
 Gabarit pour les tiroirs AXIS PRO et MODERN BOX PRO  
 Plantilla de cajón AXIS PRO y MODERN BOX PRO

NEW

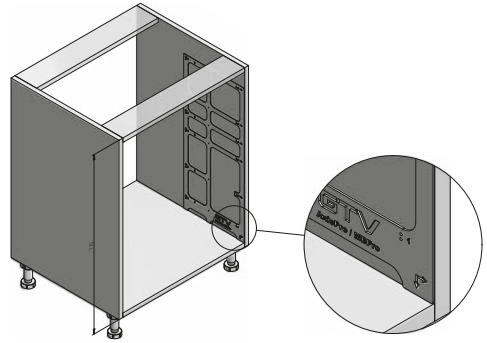
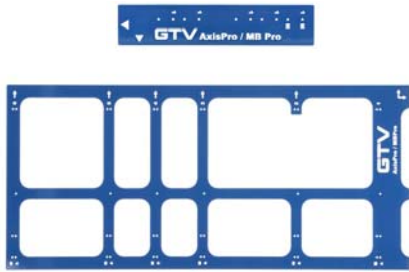

PB-SZABLON-AXIS-MBPRO

Stahl  
 acier  
 acero



\* NF - Frontauflage auf Seite 16  
 NF - pose de la façade sur le côté 16  
 NF - solapamiento de frente a pared lateral 16

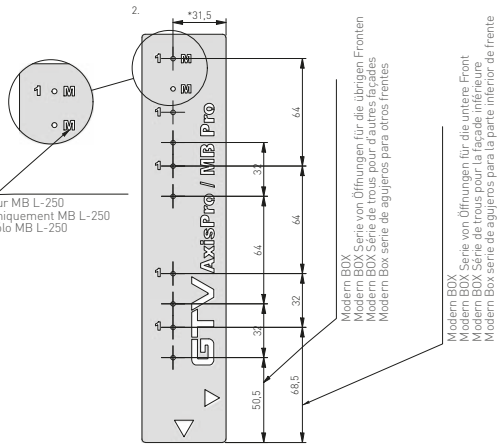
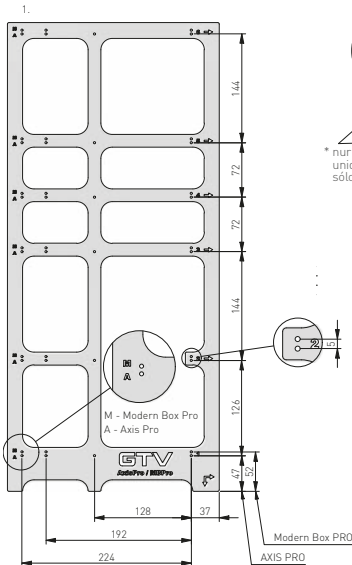

1. Schablone für AxisPro und MB (Standardschublade H=720)  
 Gabarit pour AxisPro et MB (tiror standard H=720)  
 Plantilla para AxisPro y MB (cajón estándar H=720)

2. Schablone für Front H=140 sowie H=284 (MB, AxisPro) Universal  
 Gabarit pour la façade H=140 et H=284 (MB, AxisPro) universel  
 Plantilla para frente H=140 y H=284 (MB, AxisPro) Universal





MB

Schubladeneinsatz CUSTOMI A verstellbar  
 Range-couverts CUSTOMI A réglable  
 Cubertero CUSTOMI A regulable

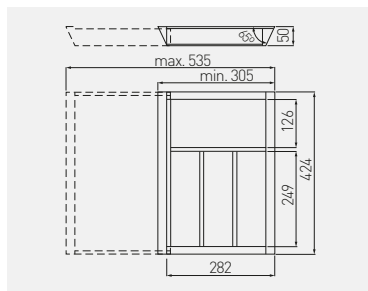

Für Schubladen Modern Box und Axis PRO L = 450  
 Pour tiroir Modern Box et Axis PRO L = 450  
 Para cajones Modern Box y Axis PRO L = 450

Maximale Breite = 535 mm  
 Coulissement maximal = 535 mm  
 Extracción máxima = 535 mm

				
W-CUSTOMI-60L450	424 x 305 mm	Klarlack matt peinture transparente mat barniz transparente mate	Buche hêtre haya	Buchenholz bois de hêtre madera de haya



Schubladeneinsatz CUSTOMI BIS A verstellbar  
 Range-couverts CUSTOMI BIS A réglable  
 Cubertero CUSTOMI BIS A regulable

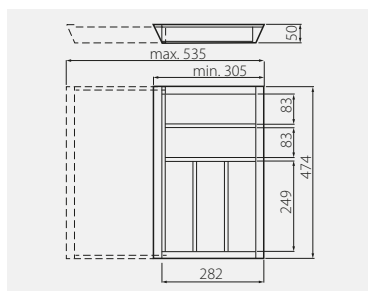

Für Schubladen Modern Box und Axis PRO L = 500  
 Pour tiroir Modern Box et Axis PRO L = 500  
 Para cajones Modern Box y Axis PRO L = 500

Maximale Breite = 535 mm  
 Coulissement maximal = 535 mm  
 Extracción máxima = 535 mm

				
W-CUSTOMI-60L500	474 x 305 mm	Klarlack matt peinture transparente mat barniz transparente mate	Buche hêtre haya	Buchenholz bois de hêtre madera de haya



Schubladeneinsatz CUSTOMI B verstellbar  
 Range-couverts CUSTOMI B réglable  
 Cubertero CUSTOMI B regulable

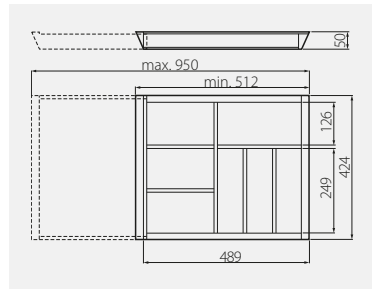

Für Schubladen Modern Box und Axis PRO L = 450  
 Pour tiroir Modern Box et Axis PRO L = 450  
 Para cajones Modern Box y Axis PRO L = 450

Maximale Breite = 950 mm  
 Coulissement maximal = 950 mm  
 Extracción máxima = 950 mm

				
W-CUSTOMI-80L450	512 x 424	Klarlack matt peinture transparente mat barniz transparente mate	Buche hêtre haya	Buchenholz bois de hêtre madera de haya



Schubladeneinsatz CUSTOMI BIS B verstellbar  
 Range-couverts CUSTOMI BIS B réglable  
 Cubertero CUSTOMI BIS B regulable

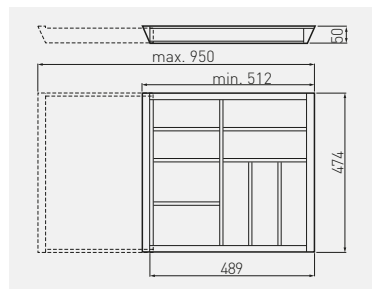

Für Schubladen Modern Box und Axis PRO L = 500  
 Pour tiroir Modern Box et Axis PRO L = 500  
 Para cajones Modern Box y Axis PRO L = 500

Maximale Breite = 950 mm  
 Coulissement maximal = 950 mm  
 Extracción máxima = 950 mm





				
W-CUSTOMI-80L500	512 x 474	Klarlack matt peinture transparente mat barniz transparente mate	Buche hêtre haya	Buchenholz bois de hêtre madera de haya

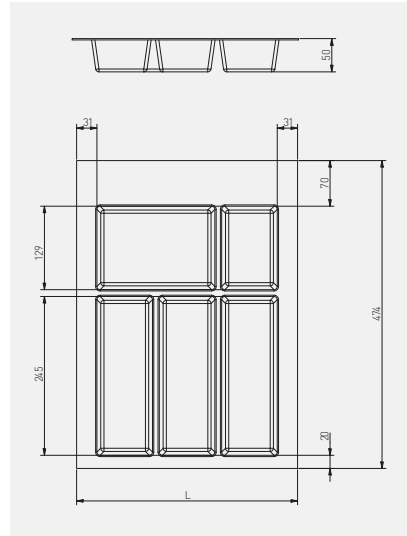

Schubladeneinsatz Axispace  
Range-couverts Axispace  
Cubertero Axispace

NEW







	 L mm	 mm		
WK-SZ-AS-400-10	282-340	400	weiß blanc blanco	Kunststoff, plastique, plástico
WK-SZ-AS-500-10	382-440	500		
WK-SZ-AS-600-10	482-540	600		
WK-SZ-AS-800-10	682-740	800	anthrazit, anthracite, antracita	
WK-SZ-AS-900-10	782-840	900		
WK-SZ-AS-400-60	282-340	400		
WK-SZ-AS-500-60	382-440	500		
WK-SZ-AS-600-60	482-540	600		
WK-SZ-AS-800-60	682-740	800		
WK-SZ-AS-900-60	782-840	900		



Antirutschmatte für Schubladen AXISPACE  
Tapis antidérapant pour tiroir AXISPACE  
Alfombrilla antideslizante para cajón AXISPACE

NEW



	 L mm		
MA-MATA-1-10	5000 x 480	weiß / blanc / blanco	Kunststoff, plastique, plástico
MA-MATA-1-20		schwarz / noir / negro	
MA-MATA-1-60		anthrazit / anthracite / antracita	



FRIENDLY

Glas- und Regalbodenträger PELIKAN klein  
Support étagère PELIKAN petit  
Soporte PELIKAN pequeño

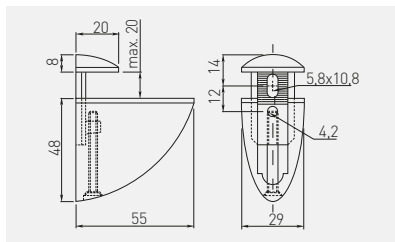

PP-MP0055-01	Chrom / chrome / cromado	ZnAl
PP-MP0055-02	Nickel matt / satiné / satinado	
PP-MP0055-05	Aluminium / aluminium / aluminio	
PP-MP0055-06	Edelstahl optik / acier brossé / acero pulido	

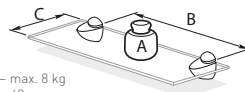

A – max. 8 kg  
B – 40 cm  
C – 20 cm

Maximale Belastung hängt von der Anzahl der Bodenträger und dem Material des Fachbodens ab.

La charge maximale dépend du nombre de supports et du matériau dont est faite la tablette.

La carga máxima depende del número de soportes y del material del que está hecha la balda.

Glas- und Regalbodenträger PELIKAN mittelgroß  
Support étagère PELIKAN moyen  
Soporte PELIKAN medio

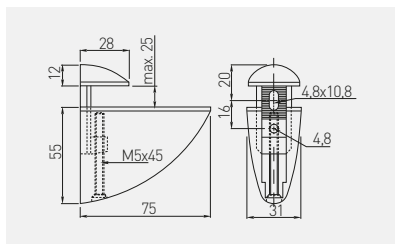

PP-SP0075-01	Chrom / chrome / cromado	ZnAl
PP-SP0075-02	Nickel matt / satiné / satinado	
PP-SP0075-05	Aluminium / aluminium / aluminio	
PP-SP0075-06	Edelstahl optik / acier brossé / acero pulido	

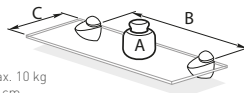

A – max. 10 kg  
B – 50 cm  
C – 25 cm

Maximale Belastung hängt von der Anzahl der Bodenträger und dem Material des Fachbodens ab.

La charge maximale dépend du nombre de supports et du matériau dont est faite la tablette.

La carga máxima depende del número de soportes y del material del que está hecha la balda.

Glas- und Regalbodenträger PELIKAN groß  
Support étagère PELIKAN grand  
Soporte PELIKAN grande

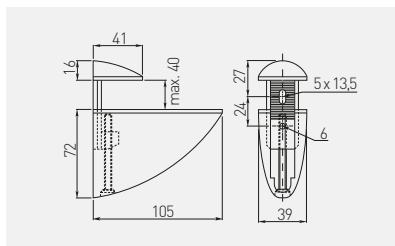

PP-DP0105-01	Chrom / chrome / cromado	ZnAl
PP-DP0105-02	Nickel matt / satiné / satinado	
PP-DP0105-05	Aluminium / aluminium / aluminio	
PP-DP0105-06	Edelstahl optik / acier brossé / acero pulido	

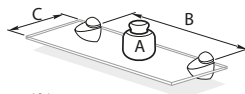

A - max. 12 kg  
B - 60 cm  
C - 30 cm

Maximale Belastung hängt von der Anzahl der Bodenträger und dem Material des Fachbodens ab.  
La charge maximale dépend du nombre de supports et du matériau dont est faite la tablette.

La carga máxima depende del número de soportes y del material del que está hecha la balda.

Glas- und Regalbodenträger GS02  
Support étagère GS02  
Soporte GS02

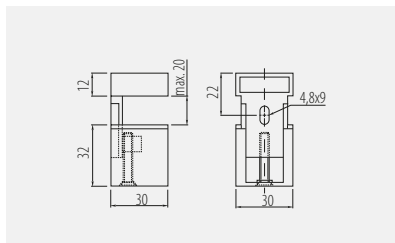

PP-00GS02-01	Chrom / chrome / cromado	ZnAl
PP-00GS02-02	Nickel matt / satiné / satinado	
PP-00GS02-05	Aluminium / aluminium / aluminio	
PP-00GS02-06	Edelstahl optik / acier brossé / acero pulido	

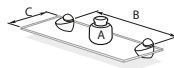

A - max. 4 kg  
B - 40 cm  
C - 20 cm

Maximale Belastung hängt von der Anzahl der Bodenträger und dem Material des Fachbodens ab.  
La charge maximale dépend du nombre de supports et du matériau dont est faite la tablette.

La carga máxima depende del número de soportes y del material del que está hecha la balda.

Glas- und Regalbodenträger GS03  
Support étagère GS03  
Soporte GS03

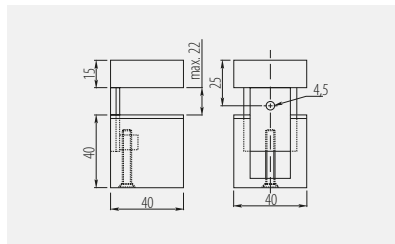

PP-00GS03-01	Chrom / chrome / cromado	ZnAl
PP-00GS03-02	Nickel matt / satiné / satinado	
PP-00GS03-05	Aluminium / aluminium / aluminio	
PP-00GS03-06	Edelstahlloptik / acier brossé / acero pulido	

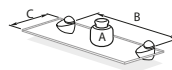

A - max. 6 kg  
B - 50 cm  
C - 25 cm

Maximale Belastung hängt von der Anzahl der Bodenträger und dem Material des Fachbodens ab.  
La charge maximale dépend du nombre de supports et du matériau dont est faite la tablette.  
La carga máxima depende del número de soportes y del material del que está hecha la balda.



Glas- und Regalbodenträger GS04  
Support étagère GS04  
Soporte GS04

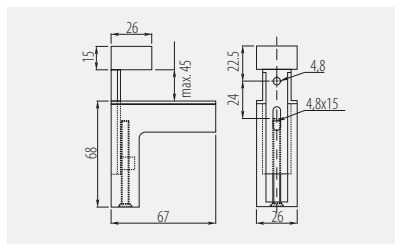

PP-00GS04-01	Chrom / chrome / cromado	ZnAl
PP-00GS04-02	Nickel matt / satiné / satinado	
PP-00GS04-05	Aluminium / aluminium / aluminio	
PP-00GS04-06	Edelstahlloptik / acier brossé / acero pulido	

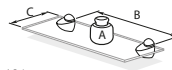

A - max. 10 kg  
B - 60 cm  
C - 30 cm

Maximale Belastung hängt von der Anzahl der Bodenträger und dem Material des Fachbodens ab.  
La charge maximale dépend du nombre de supports et du matériau dont est faite la tablette.  
La carga máxima depende del número de soportes y del material del que está hecha la balda.



Glasbodenträger A48 zum Schrauben  
Support étagère A48 à visser  
Soporte A48 atornillado

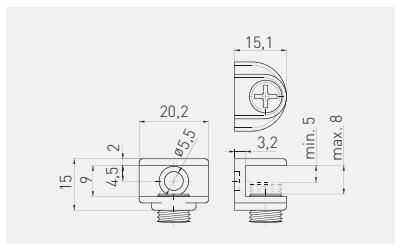

PP-GL-A48-01



Chrom / chrome / cromado



ZnAl



Glasbodenträger B48 zum Einpressen  
Support étagère B48  
Soporte B48 a presión

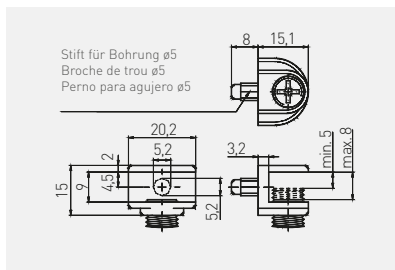

PP-GL-B48-01



Chrom / chrome / cromado



ZnAl





Glasbodenträger CGP zum Schrauben  
 Support étagère CGP à visser  
 Soporte CGP atornillado

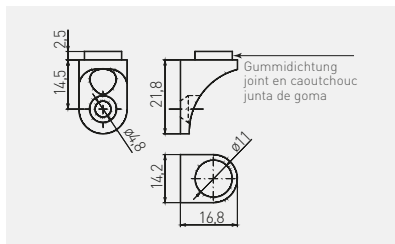

PP-GL-CGP-01	Chrom / chrome / cromado	ZnAl



Glasbodenträger E410 zum Einpressen  
 Support étagère E410  
 Soporte E410 a presión

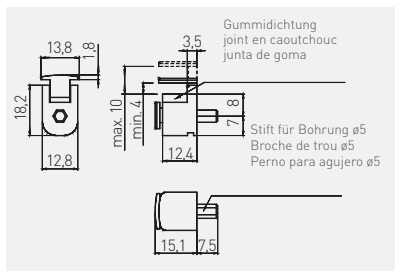

PP-GL-E410-01	Chrom / chrome / cromado	ZnAl





Glasbodenträger SL3  
Support étagère SL3  
Soporte SL3

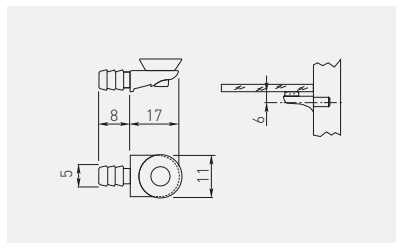

PP-S0L003-01T



Chrom / chrome / cromado



ZnAl + Kunststoff / ZnAl + plastique / ZnAl + plástico



Glasbodenträger SL12  
Support étagère SL12  
Soporte SL12

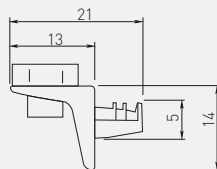

Glasstärke max. 5 mm  
Épaisseur de verre max. 5 mm  
Grosor del vidrio máx. 5 mm



PP-S0L012-01T



Chrom / chrome / cromado



ZnAl + Kunststoff / ZnAl + plastique / ZnAl + plástico



Glasbodenträger HS0  
Support étagère HS0  
Soporte HS0

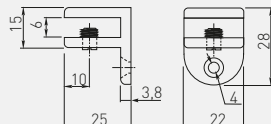

Glasstärke max. 5 mm  
Épaisseur de verre max. 5 mm  
Grosor del vidrio máx. 5 mm



PP-HS0006-01



Chrom / chrome / cromado



ZnAl



Glasbodenträger HS2  
Support étagère HS2  
Soporte HS2

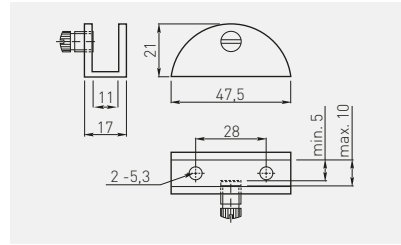

PP-HS2710-01	Chrom / chrome / cromado	ZnAl



Glasbodenträger J63  
Support étagère J63  
Soporte J63

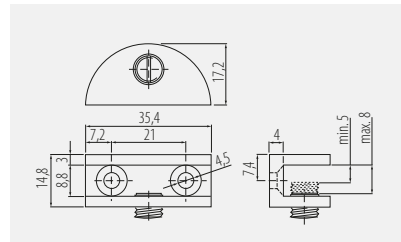



MC-J63-01	Chrom / chrome / cromado	ZnAl
MC-J63-05	Edelstahloptik / acier brossé / acero pulido	

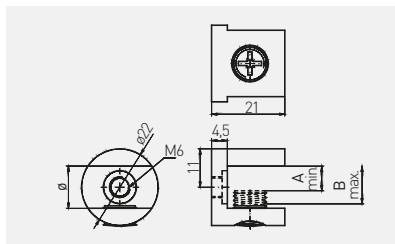

Glasbodenträger J65  
Support étagère J65  
Soporte J65



	$\varnothing$ mm	A mm	B mm		
MC-J65-08-01	8	4	8	Chrom / chrome / cromado	
MC-J65-08-05	8	4	8	Edelstahloptik / acier brossé / acero pulido	
MC-J65-10-01	10	6	10	Chrom / chrome / cromado	
MC-J65-10-05	10	6	10	Edelstahloptik / acier brossé / acero pulido	
MC-J65-12-01	12	7	11	Chrom / chrome / cromado	
MC-J65-12-05	12	7	11	Edelstahloptik / acier brossé / acero pulido	



Glasbodenträger J123  
Support étagère J123  
Soporte J123

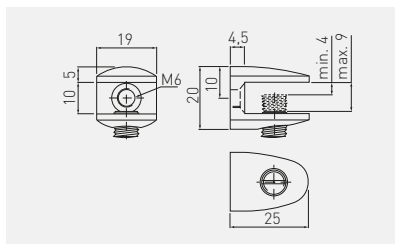

		
MC-J123-01	Chrom / chrome / cromado	
MC-J123-05	Edelstahloptik / acier brossé / acero pulido	



Glasbodenträger K135  
Support étagère K135  
Soporte K135

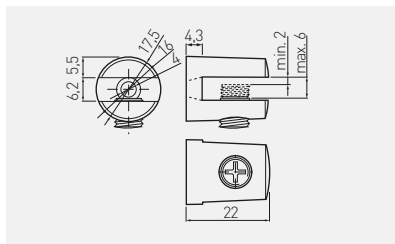

MC-K135-06-01	Chrom / chrome / cromado	ZnAl



Befestigung J01  
Fixation J01  
Fijación J01

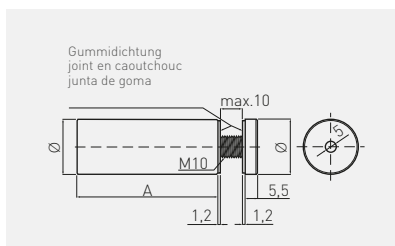





MC-J01A-12-01			Chrom / chrome / cromado
MC-J01A-12-06	12	16,5	Edelstahltopf / acier brossé / acero pulido
MC-J01A-16-01	16	25	Chrom / chrome / cromado
MC-J01A-16-06			Edelstahltopf / acier brossé / acero pulido
			Stahl acier acero
			160
			60

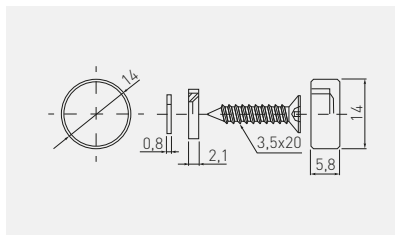

Befestigung J04  
Fixation J04  
Fijación J04



	 mm			
MC-J04A2-14-01	14	Chrom / chrome / cromado	ZnAl	300
MC-J04A2-14-05	14	Edelstahlloptik / acier brossé / acero pulido		200
MC-J04A2-18-01	18	Chrom / chrome / cromado		100
MC-J04A2-22-01	22	Chrom / chrome / cromado		



Befestigung J60  
Fixation J60  
Fijación J60

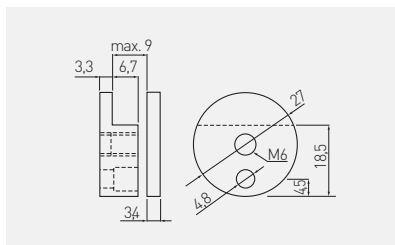

		
MC-J60A27-01	Chrom / chrome / cromado	ZnAl



Befestigung J62  
 Fixation J62  
 Fijación J62

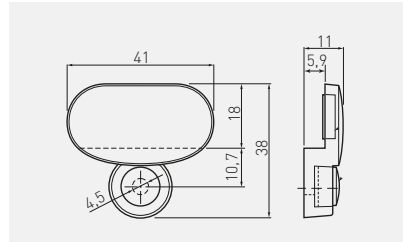

		
MC-J62-01	Chrom / chrome / cromado	ZnAl



Regalbodenträger GL  
 Support étagère GL  
 Soporte GL

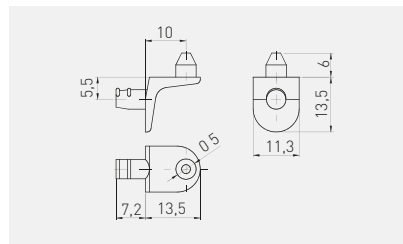

		
PP-GL-DR5-01	Chrom / chrome / cromado	ZnAl





Regalbodenträger SAFETY  
Support étagère SAFETY  
Soporte SAFETY

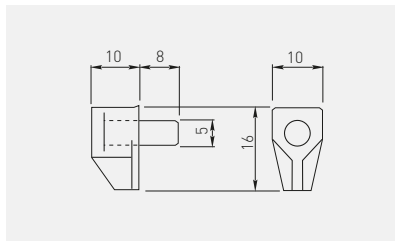

PP-SPL001-01	transparent, transparent, transparente	Stahl + Kunststoff, acier + plastique, acero + plástico,



Regalbodenträger MR-11  
Support étagère MR-11  
Soporte MR-11

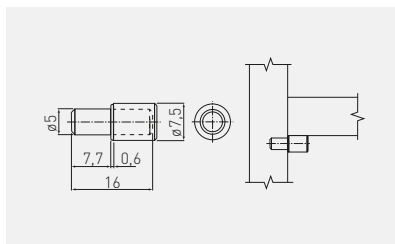

MR-ZSL011-01	mit Kappe, avec capuchon, con tapa	Chrom / chrome / cromado	Stahl acier acero
MR-TDL011-01	ohne Kappe, sans capuchon, sin tapa, f		



Regalbodenträger SMART  
Support étagère SMART  
Soporte SMART

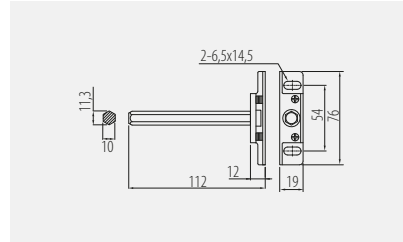





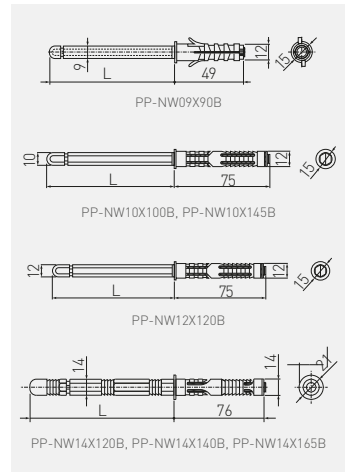

		
PP-SMART-000	silberfarben / argent / plata	Stahl / acier / acero



Regalbodenträger CLEAR  
Taquet CLEAR  
Soporte CLEAR



	 mm	 mm	 kg			
PP-NW09X90B	9	90	10	braun, bronze, marrón	Stahl acier acero	200
PP-NW10X100B	10	110	15			
PP-NW10X145B	10	145	15			
PP-NW12X120B	12	120	15			100
PP-NW14X120B	14	120	25			
PP-NW14X140B	14	140	25			
PP-NW14X165B	14	165	25			



Regalkonsole LUK  
Support étagère LUK  
Soporte LUK para estante

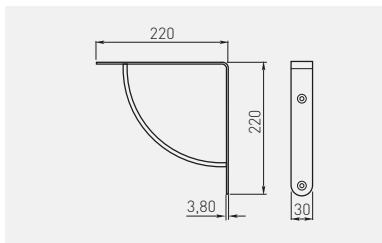

PP-LUK-00-01	30 / 2 Stk. 30 / 2 pc 30 / 2 uds.	Chrom / chrome / cromado	
PP-LUK-00-02		Nickel matt / satiné / satinado	
PP-LUK-00-05		Aluminium / aluminium / aluminio	
		Stahl acier acero	



Regalkonsole WB-24  
Support étagère WB-24  
Soporte WB-24 para estante

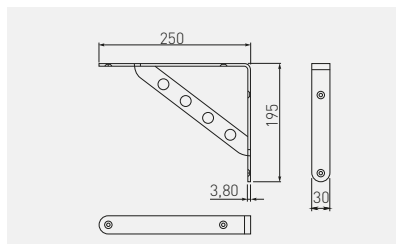

WB-073024-01	30 / 2 Stk. 30 / 2 pc 30 / 2 uds.	Chrom / chrome / cromado	
WB-073024-06		Edelstahloptik / acier brossé / acero pulido	
		Stahl acier acero	



Regalkonsole WB-25  
 Support étagère WB-25  
 Soporte WB-25 para estante

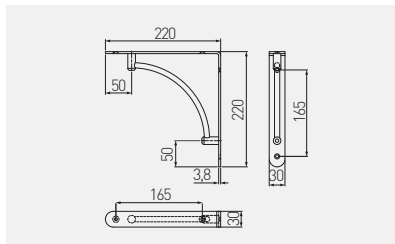

WB-073025-01	30 / 2 Stk. 30 / 2 pc	Chrom / chrome / cromado	Stahl acier acero
WB-073025-06	30 / 2 uds.	Edelstahloptik / acier brossé / acero pulido	



Regalkonsole WB-26  
 Support étagère WB-26  
 Soporte WB-26 para estante

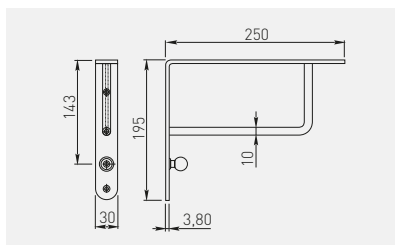

WB-073026-01	30 / 2 Stk. 30 / 2 pc	Chrom / chrome / cromado	Stahl acier acero
WB-073026-06	30 / 2 uds.	Edelstahloptik / acier brossé / acero pulido	



Regalkonsole WS12  
Support étagère WS12  
Soporte WS12

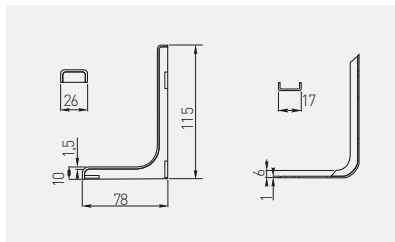

WB-WS-12-010	120 mm	8 / 2 Stk. 8 / 2 pc 8 / 2 uds.	weiß / blanc / blanco	Kunststoff, plastique, plástico



Regalkonsole WS18  
Support étagère WS18  
Soporte WS18

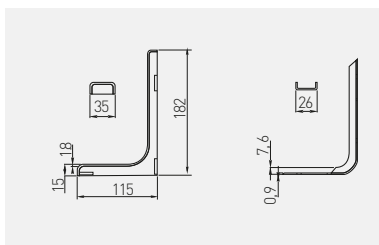

WB-WS-18-010	180	9,5 / 2 Stk. 9,5 / 2 pc 9,5 / 2 uds.	weiß / blanc / blanco	Kunststoff, plastique, plástico
WB-WS-18-020	180		schwarz / noir / negro	
WB-WS-18-060	180		grau / gris / gris	



Regalkonsole WS24  
Support étagère WS24  
Soporte WS24

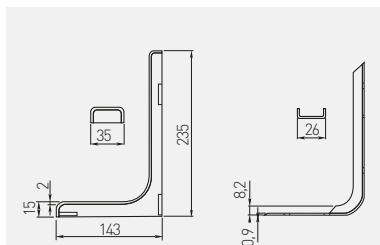

WB-WS-24-010	240	11 / 2 Stk. 11 / 2 pc	weiß / blanc / blanco	Kunststoff, plastique, plástico
WB-WS-24-020	240	11 / 2 uds.	schwarz / noir / negro	



Stuhlwinkel FS01 breit  
Équerre de fixation FS01 large  
Escuadra de fijación FS01 ancha

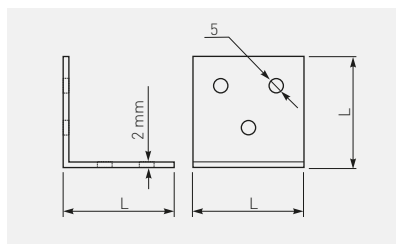

KW-FS0125-01	25 x 25 x 24	Chrom / chrome / cromado	Stahl acier acero	1500
KW-FS0140-01	40 x 40 x 40			400



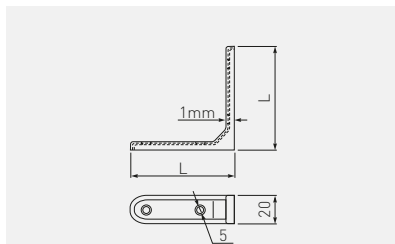

Stuhlwinkel FS03 verstärkt  
 Cornière renforcée FS03  
 Escuadra de fijación FS03 reforzada

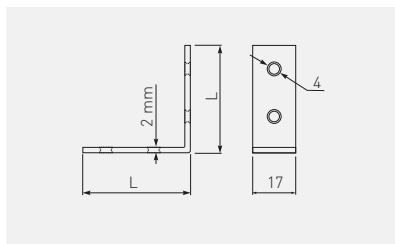

	 L mm			
KW-FS0335-01	35 x 35 x 20	Chrom / chrome / cromado	Stahl acier acero	1300
KW-FS0350-01	50 x 50 x 20			700
KW-FS0375-01	75 x 75 x 20			400

Stuhlwinkel FS04 Standard  
 Équerre de fixation FS04 standard  
 Escuadra de fijación FS04 estándar



	 L mm			
KW-FS0425-03	25 x 25 x 17	Messing / laiton / latón	Stahl acier acero	1500
KW-FS0450-03	50 x 50 x 17			600

Eckwinkel FS06  
Équerre de fixation FS06 d'angle  
Escuadra FS06 para esquina

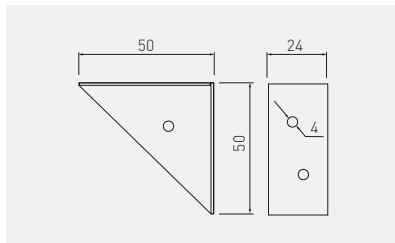

KW-FS0650-01



50 x 50 x 24  
mm



Chrom / chrome / cromado



Stahl / acier / acero



Kunststoffwinkel MONT, einzeln  
Taquet MONT simple  
Esquina MONT simple

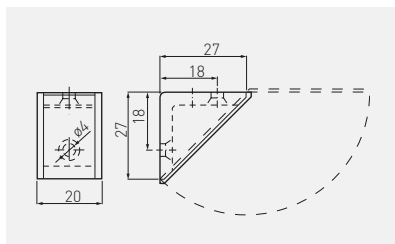

PP-PMONT0M-01\*

weiß / blanc / blanco

PP-PMONT0M-07\*

dunkelbraun / brun foncé / marrón oscuro

PP-PMONT0M-08\*

grau / gris / gris

PP-PMONT0M-22\*

Elfenbein / ivoire / marfil



Kunststoff,  
plastique,  
plástico



\*Produkt erhältlich auf individuelle Bestellung / Produit disponible sur demande / Producto disponible bajo demanda



Kunststoffwinkel MONT, doppelt  
 Double taquet MONT  
 Esquina MONT doble

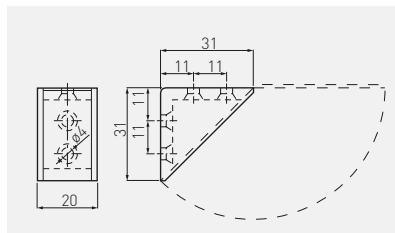

		
PP-PMONT0D-22*	Elfenbein / ivoire / marfil	Kunststoff, plastique, plástico



\*Produkt erhältlich auf individuelle Bestellung / Produit disponible sur demande / Producto disponible bajo demanda

Kunststoffwinkel NARS, einzeln  
 Taquet simple NARS  
 Esquina NARS simple

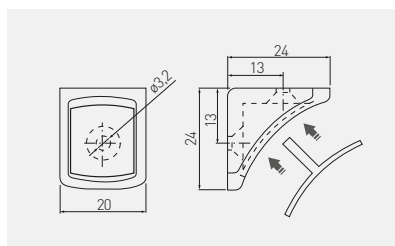

		
PM-NAR1003-11	Elfenbein / ivoire / marfil	Kunststoff, plastique, plástico
PM-NAR1003-19	grau / gris / gris	
PM-NAR1003-10	weiß / blanc / blanco	



\*Produkt erhältlich auf individuelle Bestellung / Produit disponible sur demande / Producto disponible bajo demanda

Kunststoffwinkel NARS, doppelt  
 Double taquet NARS  
 Esquina NARS doble

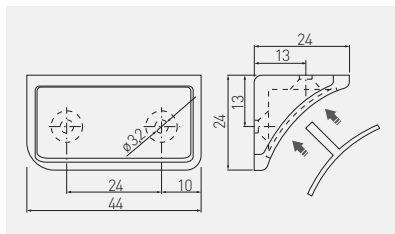

PM-NAR1004-11	Elfenbein / ivoire / marfil	Kunststoff, plastique, plástico
PM-NAR1004-19	grau / gris / gris	
PM-NAR1004-10	weiß / blanc / blanco	



\*Produkt erhältlich auf individuelle Bestellung / Produit disponible sur demande / Producto disponible bajo demanda

Rückwandstabilisator  
 Stabilisateur de panneau arrière  
 Estabilizador del panel trasero

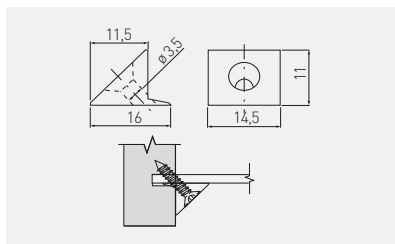

WZ-SCTYLPR-WK	mit Schraube 3,5 x 20 Avec vis de 3,5 x 20 con tornillo 3,5 x 20	transparent, transparent, transparente	Kunststoff, plastique, plástico
WZ-SCTYLPR-BWK	ohne Schraube Sans vis sin tornillo		





Schrankaufhänger R1  
 Fixation de suspension de cuisine R1  
 Colgador para mueble de cocina R1

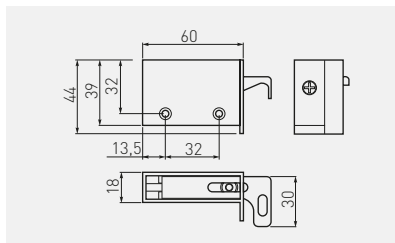

ZK-R1-KPL-10	90 / 2 Stk. 90 / 2 pc 90 / 2 uds.	weiß / blanc / blanco	Stahl + Kunststoff, acier + plastique, acero + plástico,



Aufhänger FORZA  
 Colgador de muebles FORZA  
 Fixation de suspension pour meuble FORZA

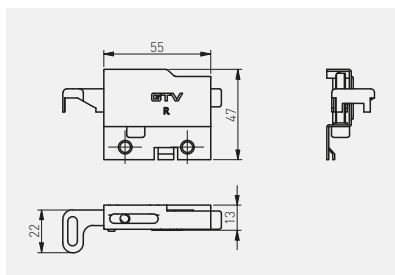

ZK-FORZA-ZAW-KPL	130 / 2 Stk. 130 / 2 pc 130 / 2 uds.	1 Set = L+R 1 ensemble = G+D 1 jgo. = I+D 1	silberfarben, argent, plata	Stahl + Kunststoff, acier + plastique, acero + plástico,



Abdeckkappen für Schrankaufhänger Forza  
 Embout de suspension Forza  
 Cubre herraje Forza

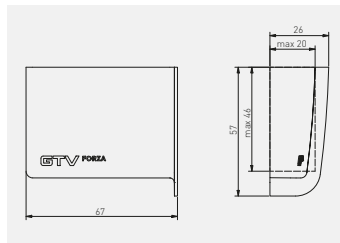

ZK-FORZA-ZAS-KPL-010	1 Set = L+R 1 ensemble = G+D 1 jgo. = l+D 1	weiß / blanc / blanco	Kunststoff, plastique, plástico
ZK-FORZA-ZAS-KPL-020		schwarz / noir / negro	



Aufhängeschiene  
 Bande de montage  
 Barra de montaje

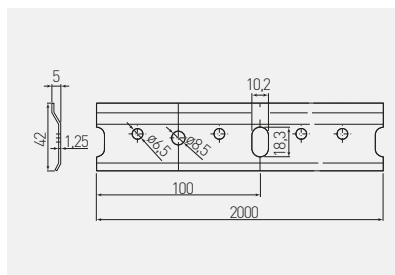

LO-M2M-00-125-A	2000 mm	verzinkt galvanisé galvanizado	Stahl acier acero



Arbeitsplattenverbinder  
Raccord vissé sur plan de travail  
Conector para encimeras de tornillo

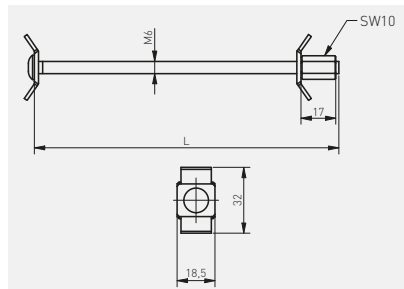

	L mm		
EM-SBL065-01-A	65	Chrom / chrome / cromado	Stahl acier acero
EM-SBL100-01-A	100		
EM-SBL150-01-A	150		



Exzenterverbinder für regale  
Ferrure de raccordement excentrique pour étagères  
Conexión excéntrica para estantes

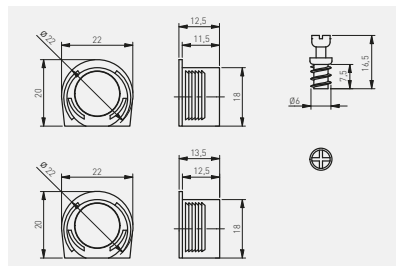

	$\varnothing$ mm			
MM-FI20X6X7-PL10-A-1T	20	Bolzen 6 x 16,5 mm broche 6 x 16,5 mm perno de sujeción 6 x 16,5 mm	weiß / blanc / blanco	ZnAl + Kunststoff, ZnAl + plastique, ZnAl + plástico
MM-FI20X6X7-PL20-A-1T			schwarz / noir / negro	
MM-FI20X6X7-PL30-A-1T			braun / bronze / marrón	
MM-FI20X6X7-PL80-A-1T			grau / gris / gris	
MM-FI20X6X7-ZN-A-1T			silberfarben / argent / plata	



Schnellverbinder  
Raccord rapide  
Conector rápido



SZ-005-00-01T  
SZ-008-00-01T



SZ-005-00-01-AT  
SZ-008-00-01-AT

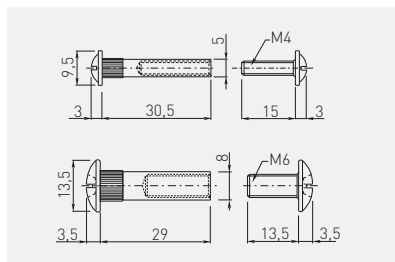

	mm			
SZ-005-00-01T	5		Stahl acier acero	
SZ-005-00-01-AT				
SZ-008-00-01T	8			Chrom / chrome / cromado
SZ-008-00-01-AT				



Spanplattenschraube  
Vis à bois  
Tornillo rosca madera

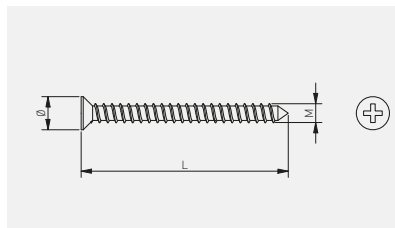

	mm			
WK-D0320-001*	3 x 20		Stahl acier acero	
WK-D0325-001*	3 x 25			
WK-D0330-001*	3 x 30			
WK-D0416-001	4 x 16			Chrom chrome cromado
WK-D0425-001*	4 x 25			
WK-D0430-001	4 x 30			
WK-D0440-001*	4 x 40			
WK-D0460-001*	4 x 60	Chrom chrome cromado	Stahl acier acero	
WK-D3516-001	3,5 x 16			
WK-D3530-001	3,5 x 30			

\*Produkt erhältlich auf individuelle Bestellung / Produit disponible sur demande / Producto disponible bajo demanda

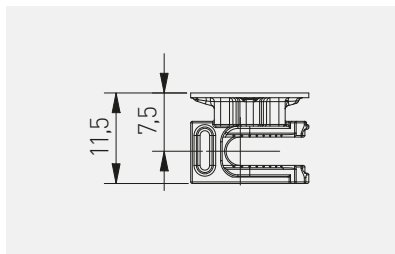

Exzenter  
 Excentrique  
 Excéntrica

WK-CAM-15-12-D	Ø15 x 12	silberfarben / argent / plata	ZnAl
WK-CAM-15-13-D*	Ø15 x 13		

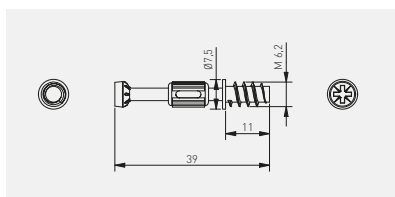

\*

 Exzenterverbinder  
 Broche pour montage excentrique  
 Perno para excéntrica

WK-DOW63X45B-D	6,3 x 45	silberfarben, schwarz argent, noir plata, negro	Stahl + Kunststoff, acier + plastique, acero + plástico,
WK-DOW63X39-D	6,3 x 39		
WK-DOW63X35B-D	6,3 x 35	silberfarben, grün argent, vert plata, verde	
WK-DOW63X31G-D	6,3 x 31		





Set – Excenter und Stift  
 Ensemble boîtier excentrique et goujon  
 Set de conexiones excéntricas y pernos



	 mm		
WK-CAM-15-DOW63X45-KPL-1T	6,3 x 45	silberfarben, schwarz argent, noir plata, negro	Stahl + Kunststoff + ZnAl, acier + plastique + ZnAl, acero + plástico + ZnAl
WK-CAM-15-DOW63X39-KPL-1T	6,3 x 39	silberfarben, rot argent, rouge plata, rojo	
WK-CAM-15-DOW63X35-KPL-1T	6,3 x 35	silberfarben, grün argent, vert plata, verde	
WK-CAM-15-DOW63X31-KPL-1T	6,3 x 31		



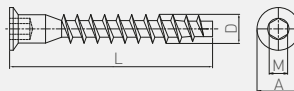

\*Produkt erhältlich auf individuelle Bestellung / Produit disponible sur demande / Producto disponible bajo demanda

Konfirmatschraube  
 Vis confirmat  
 Tornillo de ensamblaje



		L	D	A	M
WK-CF6450-01	6,4 x 50	50	6,4	9,5	4
WK-CF0750-01	7 x 50	50	7	10	4

		
WK-CF6450-01*	Chrom / chrome / cromado	Stahl acier acero
WK-CF0750-01*		



\*Produkt erhältlich auf individuelle Bestellung / Produit disponible sur demande / Producto disponible bajo demanda

Magnetschnäpper MENSA  
 Aimant MENSA  
 Imán MENSA

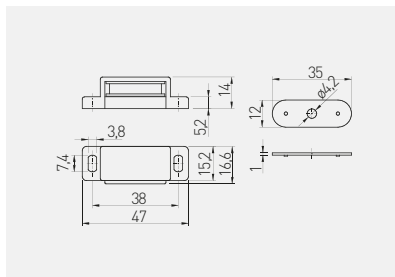





		
MG-MENSA-010	weiß / blanc / blanco	Stahl + Kunststoff, acier + plastique, acero + plástico,
MG-MENSA-030	braun / bronze / marrón	

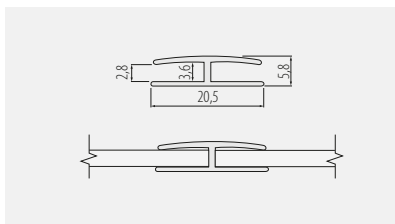

Möbelprofil PFM – Typ H  
 Profilé de meuble PFM – type H  
 Perfil para muebles PFM – tipo H



			
PM-PFMH51-10*	2000	dunkelbraun / brun foncé / marrón oscuro	Kunststoff plástico
PM-PFMH61-10*	2000	Dunkelmahagoni / acajou foncé / caoba oscuro	
PM-PFMH50-24*	2400	weiß / blanc / blanco	
PM-PFMH50-25*	2500	weiß / blanc / blanco	
PM-PFMH55-25*	2500	schwarz / noir / negro	
PM-PFMH64-25*	2500	Mahagoni / acajou / caoba	



Zierleiste, flach  
Bande décorative plate  
Embellecedor decorativo plano



Klebeband  
Bande autoadhésive  
Cinta autoadhesiva

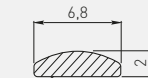

LO-00-00-001*	2000	Chrom / chrome / cromado	Kunststoff plástico
LO-00-00-003	2000	Messing / laiton / latón	



\*Produkt erhältlich auf individuelle Bestellung / Produit disponible sur demande / Producto disponible bajo demanda

Seitenleiste 38  
Profilé latéral 38  
Cubrecantos para encimeras 38

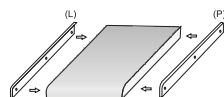

für Arbeitsplattenstärke 38 mm  
Pour plans de travail d'épaisseur 38 mm  
Para encimeras de 38 mm de grosor

LMB-BOCZ38L-05	links / gauche / izquierdo	600	Aluminium / aluminium / aluminio	Aluminium aluminio aluminio
LMB-BOCZ38L-20M			schwarz / noir / negro	
LMB-BOCZ38P-05	rechts / droit / derecho		Aluminium / aluminium / aluminio	
LMB-BOCZ38P-20M			schwarz / noir / negro	



Winkelleiste 38  
 Profilé d'angle 38  
 Cubrejuntas para encimeras 38

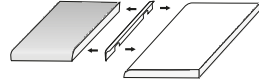

für Arbeitsplattenstärke 38 mm  
 Pour plans de travail d'épaisseur 38 mm  
 Para encimeras de 38 mm de grosor



LMB-KAT38-05	600	Aluminium / aluminium / aluminio	Aluminium aluminium aluminio
LMB-KAT38-20M		schwarz / noir / negro	



\*Produkt erhältlich auf individuelle Bestellung / Produit disponible sur demande / Producto disponible bajo demanda



Schlitzleiste 38  
 Profilé d'étanchéité 38  
 Cubre juntas para encimera 38

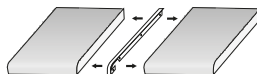

für Arbeitsplattenstärke 38 mm  
 Pour plans de travail d'épaisseur 38 mm  
 Para encimeras de 38 mm de grosor

	 L mm		
LMB-SZCZ38-05	600	Aluminium / aluminium / aluminio	Aluminium aluminium aluminio
LMB-SZCZ38-20M		schwarz / noir / negro	



Schrankstange oval  
 Barre ovale  
 Tubo ovalado

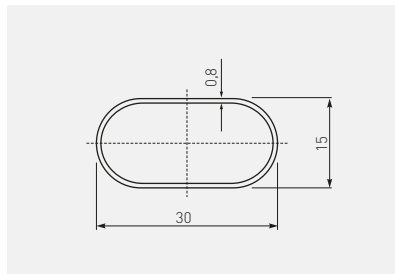

	 L mm		
RR-CH-0W-000	3000	Chrom / chrome / cromado	Stahl / acier / acero



Stangenlager RDR für Schrankstange oval  
 Support barre ovale  
 Soporte RDR para tubo ovalado

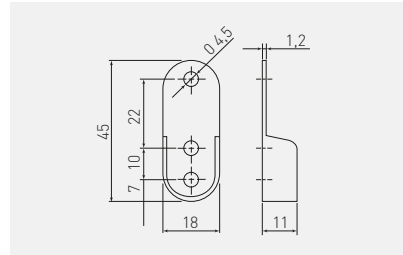

MR-RDRO-000



Chrom / chrome / cromado



Stahl / acier / acero



Halterung WP-28 für Schrankstange oval  
 Support WP-28 pour tube ovale  
 Soporte WP-28 para tubo ovalado

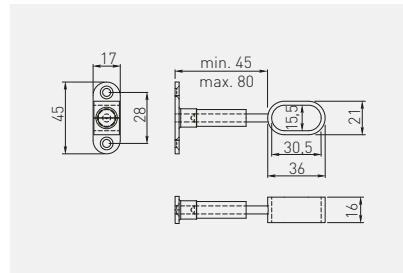

MR-WP-028-01



Chrom / chrome / cromado





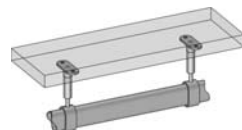



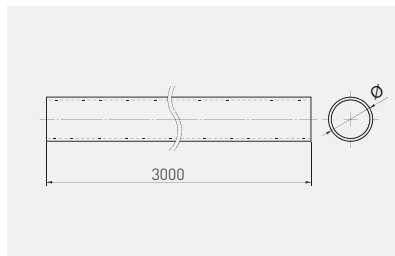





ZnAl



Schrankstange rund  
Barre ronde  
Tubo redondo



		 mm	 mm	 mm		
RR-161030H01		16	1	3000	Chrom chrome cromado	Stahl acier acero
RR-161230H01		16	1,2			
RR-250730H01		25	0,7			
RR-250830H01		25	0,8			
RR-250930H01		25	0,9			

		 mm	 mm	 mm		
RR-251030H01		25	1	3000	Chrom chrome cromado	Stahl acier acero
RR-401230H01*		40	1,2			
RR-501030H01		50	1			
RR-501230H01		50	1,2			



\*Produkt erhältlich auf individuelle Bestellung / Produit disponible sur demande / Producto disponible bajo demanda



Stangenlager R-25 für Schrankstange rund  
 Rosette R-25 barre ronde  
 Soporte R-25 para tubo redondo

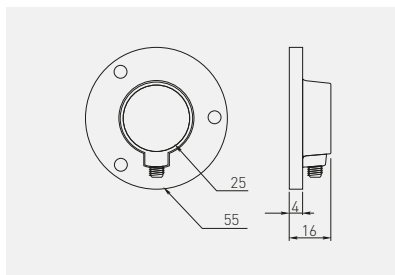

	 mm		
MR-RS025-001	25	Chrom / chrome / cromado	Stahl / acier / acero



Stangenlager R-50 für Schrankstange rund  
 Rosette R-50 barre ronde  
 Soporte R-50 a para tubo redondo

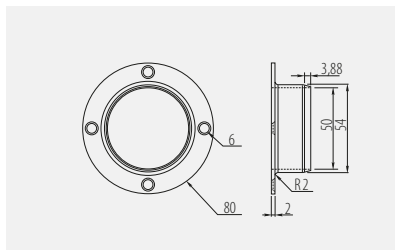

	 mm		
MR-R0050-001	50	Chrom / chrome / cromado	Stahl / acier / acero





Unteres Stangenlager PZ-2 für Schrankstange rund  
 PZ-2 support inférieur pour barre ronde  
 Soporte PZ-2 inferior a para tubo redondo

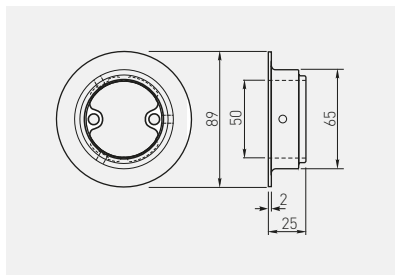

	 mm		
MR-WPZ002-01	50	Chrom / chrome / cromado	Stahl / acier / acero



Befestigungsring PZ-3  
 Bague de fixation PZ-3  
 Anillo de montaje PZ-3

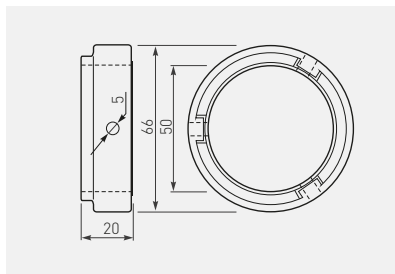

	 mm		
MR-WPZ003-01	50	Chrom / chrome / cromado	ZnAl



Halterung WP-10, verstellbar  
Support WP-10, réglable  
Soporte WP-10 distanciador, ajustable

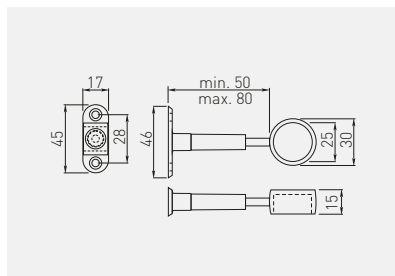

MR-WP-010-01



25



Chrom / chrome / cromado



ZnAl



Halterung WP-11, verstellbar, mit Kappe  
Support WP-11 ajustable avec bouchon  
Soporte WP-11 distanciador, ajustable con tapa

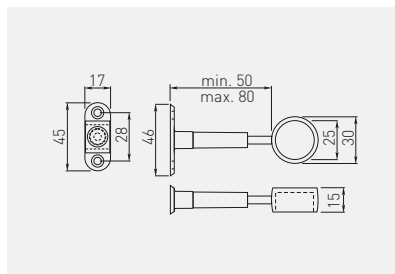

MR-WP-011-01



25



Chrom / chrome / cromado



ZnAl



Halterung THA-12  
Support de barre THA-12  
Soporte THA-12 distanciador

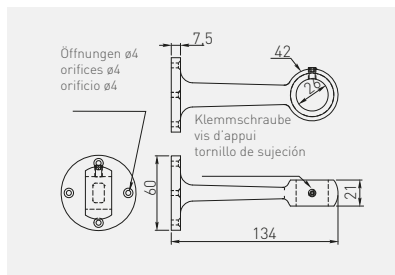

	 mm		
MR-THA12-001	25	Chrom / chrome / cromado	ZnAl



Halterung THB-12, mit Kappe  
Support de barre THB-12  
Soporte THB-12 distanciador

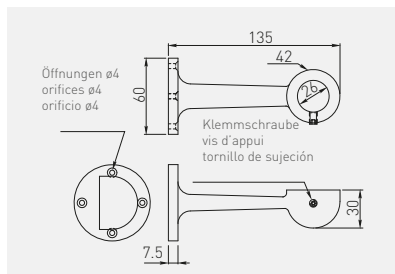

	 mm		
MR-THB12-001	25	Chrom / chrome / cromado	ZnAl



Verbinder TH-5  
Raccord TH-5 à bras double  
Conector TH-5 de doble brazo

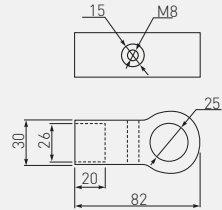

	 mm		
MR-TH005-001	25	Chrom / chrome / cromado	ZnAl



Verbinder TH-16  
Raccord TH-16 à bras double  
Conector TH-16 de doble brazo

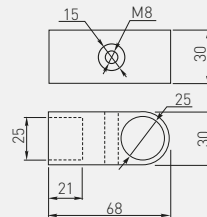

	 mm		
MR-TH016-001	25	Chrom / chrome / cromado	ZnAl



Verbinder TH-4 Typ T  
Raccord TH-4 à double bras type T  
Conector TH-4 de doble brazo tipo T

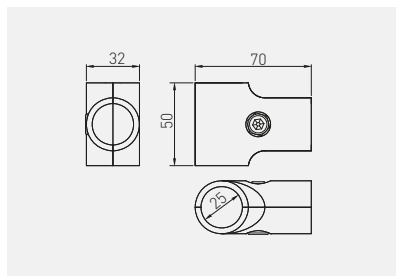

	 mm		
MR-TH004-001	25	Chrom / chrome / cromado	ZnAl



Verbinder-Set TH-18 Typ L  
Jeu de raccords TH-18 type L  
Juego de conectores TH-18 tipo L

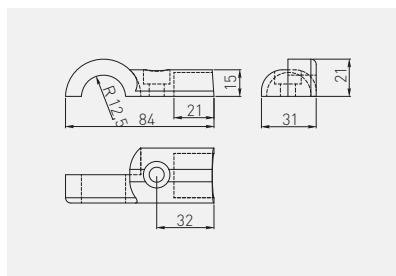



Verschiedene Verbindungsstellungen möglich  
Possibilité d'obtenir différentes positions de connexion  
Es posible obtener la conexión en varias posturas

		 mm		
MR-TH018-KPL	rechts / links droit / gauche derecha / izquierda	25	Chrom / chrome / cromado	ZnAl

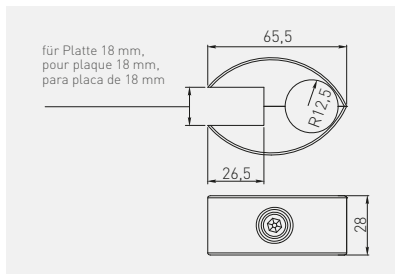

Verbinder TH-9  
Raccord TH-9  
Conector TH-9



		
MR-TH009-001	Chrom / chrome / cromado	ZnAl



Empfohlene Glasstärke mit Einlagen: 4-8 mm  
Épaisseur de verre recommandée avec inserts: 4-8 mm  
Grosor recomendado de vidrio con insertos: 4-8 mm

Verbinder-Set TH-35  
Ensemble de raccords TH-35  
Juego de conectores TH-35

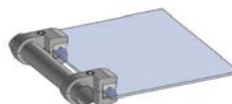
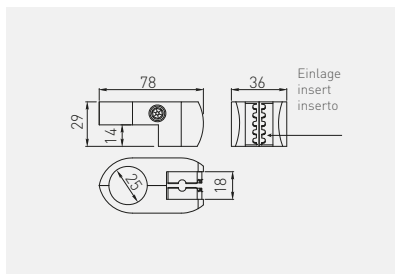

	 mm		
MR-TH035-KPL	25	Chrom / chrome / cromado	ZnAl



Empfohlene Glasstärke mit Einlagen: 4-8 mm  
Épaisseur de verre recommandée avec inserts: 4-8 mm  
Grosor recomendado de vidrio con insertos: 4-8 mm

Verbinder WP-15  
Raccord WP-15  
Conector WP-15



Einstellschrauben  
vis de réglage  
tornillos de ajuste

Befestigungsschrauben  
vis de fixation  
tornillos de fijación

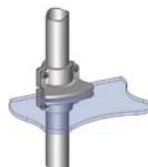
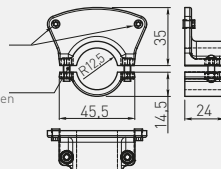

	 mm		
MR-WP-15-KPL	25	Chrom / chrome / cromado	ZnAl



Verbinder TH-2 dreifach  
Raccord TH-2 triple  
Conector TH-2 triple

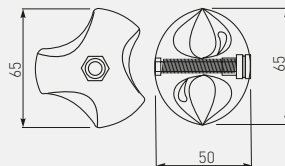

			
MR-TH002-L01	links / gauche / izquierdo	Chrom / chrome / cromado	ZnAl
MR-TH002-P01	rechts / droit / derecho		



Doppelverbinder TH-18  
Raccord TH-18 double  
Conector TH-18 doble

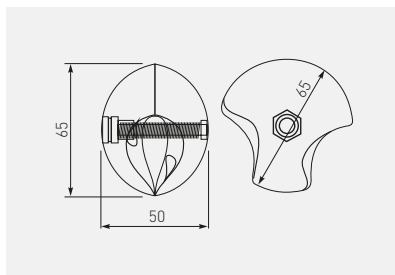

			
MR-TH018-L01	links / gauche / izquierdo	Chrom / chrome / cromado	ZnAl
MR-TH018-P01	rechts / droit / derecho		



Runde Kappe  
Embout rond  
Terminal redondo

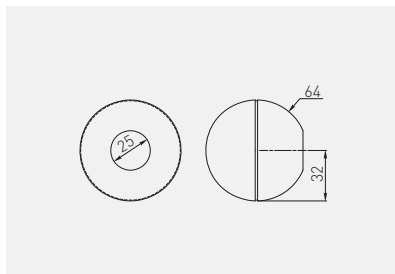

			
MR-THQZ1-001	25 mm	Chrom / chrome / cromado	ZnAl





Kappe TH-19  
Embout TH-19  
Terminal TH-19

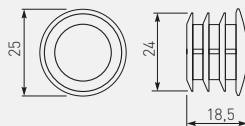

	 mm		
MR-TH019-001	25	Chrom / chrome / cromado	ZnAl



Äußerer Kunststofffuß  
Butée en plastique extérieure  
Pie de plástico exterior

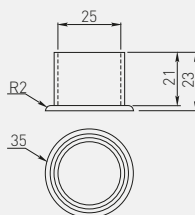

	 mm		
MR-TH019-003	25	schwarz noir negro	Kunststoff plastique plástico



Relinghalter, gerade  
Support de rail droit  
Soporte para varilla recta

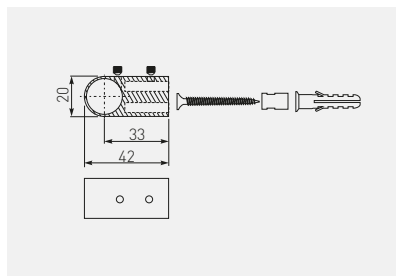

MR-WP2802-01

16

Chrom / chrome / cromado

ZnAl



Relingkappe, gerade  
Embout de rail droit  
Tapa para varilla, recta

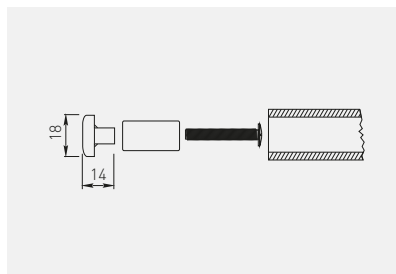

MR-WP2815-01

16

Chrom / chrome / cromado

ZnAl



Relinghalter  
Support de rail  
Soporte para tubo

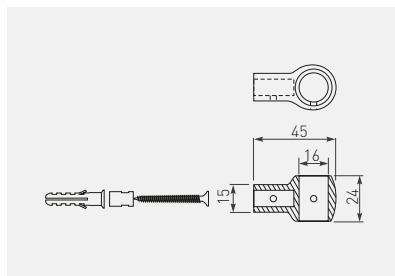

	 mm		
MR-WP2804-01	16	Chrom / chrome / cromado	ZnAl



Relingkappe  
Embout pour rail  
Tapón para tubo

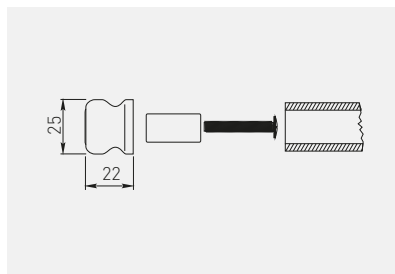

	 mm		
MR-WP2806-01	16	Chrom / chrome / cromado	Stahl + Kunststoff / acier + plastique / acero + plástico



Rellingverbinder  
Raccord de rail  
Conector para varillas

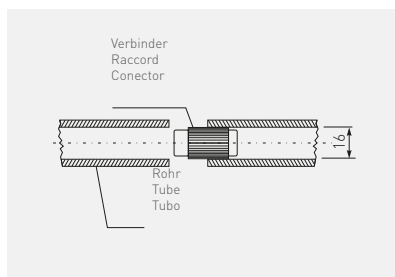

	 mm		
MR-WP2807-20	16	schwarz / noir / negro	Kunststoff / plastique / plástico



Rellingendkappe mit Gewinde  
Embout pour rail fileté  
Tapón roscado para tubos

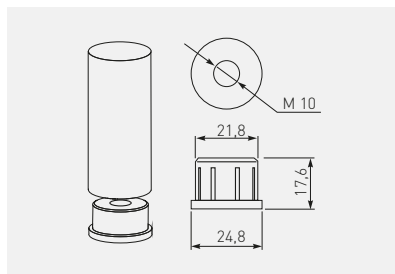

		
MR-WP2023-01	Chrom / chrome / cromado	ZnAl



Haken für Reling PS1  
 Crochets pour rail PS1  
 Ganchos de tubos PS1

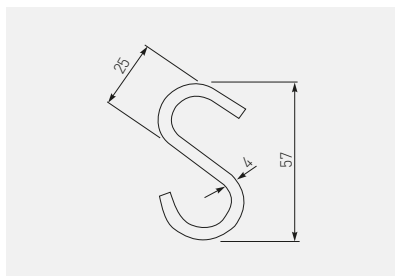

	 mm		
MR-WPS01-001	16	Chrom / chrome / cromado	Stahl / acier / acero



Haken für Reling PS3  
 Crochets pour rail PS3  
 Ganchos de tubos PS3

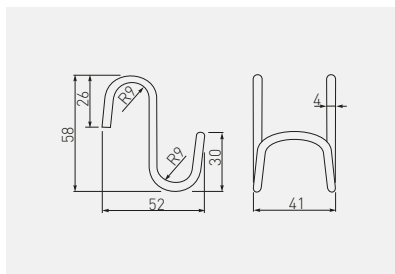





	 mm		
MR-WPS03-001	16	Chrom / chrome / cromado	Stahl / acier / acero

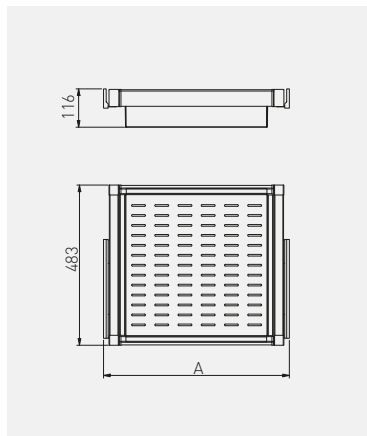

Metallkorb ELITE  
Panier métallique ELITE  
Cesto metálico ELITE





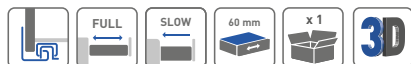

	A min./max.			
WG-KOSZM60-10	560 – 618	Vollauszug totale completa	weiß blanc blanco	Stahl + Kunststoff, acier + plastique, acero + plástico,
WG-KOSZM70-10	660 – 718			
WG-KOSZM80-10	760 – 818			
WG-KOSZM90-10	860 – 918			
WG-KOSZM60-60	560 – 618		anthrazit, anthracite, antracita	
WG-KOSZM70-60	660 – 718			
WG-KOSZM80-60	760 – 818			
WG-KOSZM90-60	860 – 918			

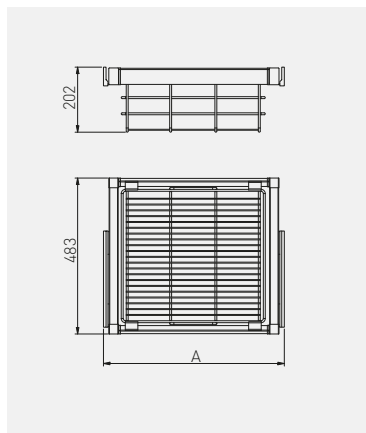

Garderobenkorb ELITE  
Panier maille ELITE  
Cesto calado ELITE





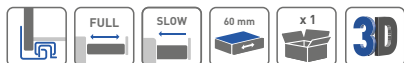

	A min./max.			
WG-KOSZ60-10	560 – 618	Vollauszug totale completa	weiß blanc blanco	Stahl + Kunststoff, acier + plastique, acero + plástico,
WG-KOSZ70-10	660 – 718			
WG-KOSZ80-10	760 – 818			
WG-KOSZ90-10	860 – 918			
WG-KOSZ60-60	560 – 618		anthrazit, anthracite, antracita	
WG-KOSZ70-60	660 – 718			
WG-KOSZ80-60	760 – 818			
WG-KOSZ90-60	860 – 918			

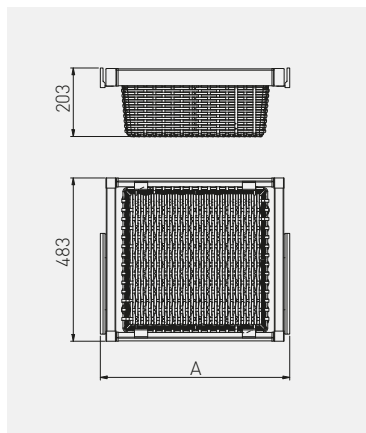

Rattankorb ELITE  
Panier en rotin ELITE  
Cesto de ratán ELITE



	A min./max.			
WG-KOSZR60-10	560 - 618	Vollauszug totale completa	weiß blanc blanco	Stahl + Kunststoff, acier + plastique, acero + plástico,
WG-KOSZR70-10	660 - 718			
WG-KOSZR80-10	760 - 818			
WG-KOSZR90-10	860 - 918			
WG-KOSZR60-60	560 - 618		anthrazit, anthracite, antracita	
WG-KOSZR70-60	660 - 718			
WG-KOSZR80-60	760 - 818			
WG-KOSZR90-60	860 - 918			

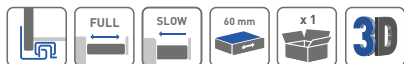



Metallschuhablage ELITE  
 Panier à chaussures métallique ELITE  
 Cajón zapatero metálico ELITE

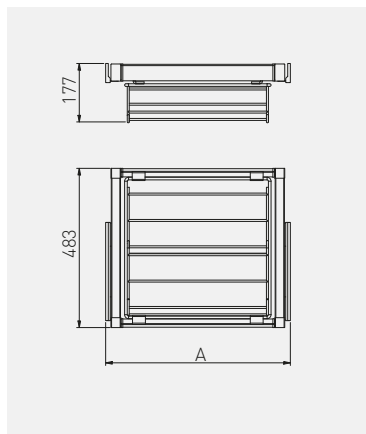



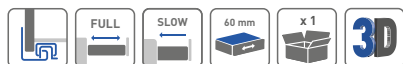

	 A min./max.			
WG-POBUW60-10	560 - 618	Vollauszug totale completa	weiß blanc blanco	Stahl + Kunststoff, acier + plastique, acero + plástico,
WG-POBUW70-10	660 - 718			
WG-POBUW80-10	760 - 818			
WG-POBUW90-10	860 - 918			
WG-POBUW60-60	560 - 618		anthrazit, anthracite, antracita	
WG-POBUW70-60	660 - 718			
WG-POBUW80-60	760 - 818			
WG-POBUW90-60	860 - 918			

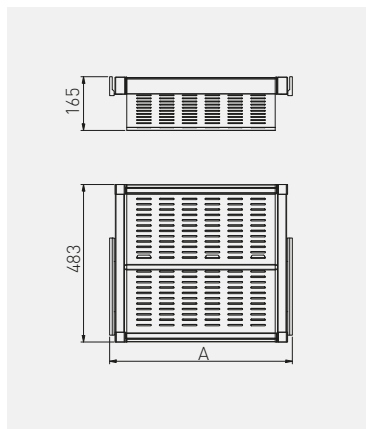

Metallschuhablage ELITE  
 Panier à chaussures métallique ELITE  
 Cajón zapatero metálico ELITE





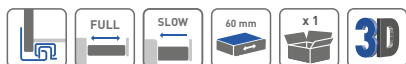

	A min./max.			
WG-POBUWM60-10	560 - 618	Vollauszug totale completa		weiß blanc blanco
WG-POBUWM70-10	660 - 718			
WG-POBUWM80-10	760 - 818			
WG-POBUWM90-10	860 - 918			
WG-POBUWM60-60	560 - 618			anthrazit, anthracite, antracita
WG-POBUWM70-60	660 - 718			
WG-POBUWM80-60	760 - 818			
WG-POBUWM90-60	860 - 918			

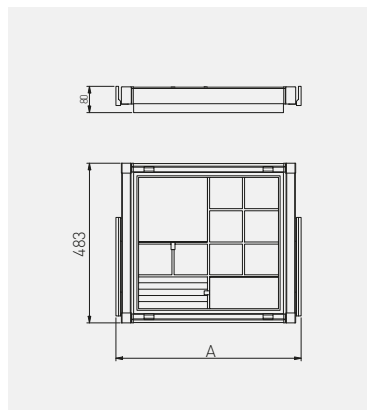

Organizer ELITE  
Organisateur ELITE  
Organizador ELITE





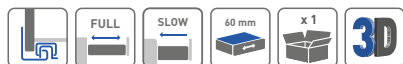

	A min./max.			
WG-PRZEG60-10	560 - 618	Vollauszug totale completa	weiß blanc blanco	Stahl + Kunststoff, acier + plastique, acero + plástico,
WG-PRZEG70-10	660 - 718			
WG-PRZEG80-10	760 - 818			
WG-PRZEG90-10	860 - 918			
WG-PRZEG60-60	560 - 618		anthrazit, anthracite, antracita	
WG-PRZEG70-60	660 - 718			
WG-PRZEG80-60	760 - 818			
WG-PRZEG90-60	860 - 918			

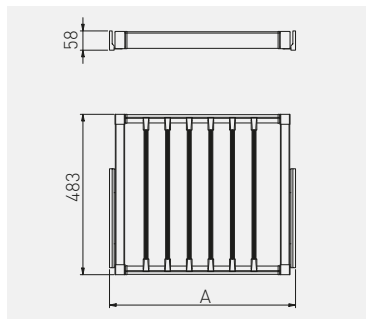

Hosenaufhänger ELITE  
Porte-pantalon ELITE  
Colgador ELITE para pantalones



	A min./max.			
WG-WSP0D60-10	560 – 618	Vollauszug totale completa	weiß blanc blanco	Stahl + Kunststoff, acier + plastique, acero + plástico.
WG-WSP0D70-10	660 – 718			
WG-WSP0D80-10	760 – 818			
WG-WSP0D90-10	860 – 918			
WG-WSP0D60-60	560 – 618		anthrazit, anthracite, antracita	
WG-WSP0D70-60	660 – 718			
WG-WSP0D80-60	760 – 818			
WG-WSP0D90-60	860 – 918			

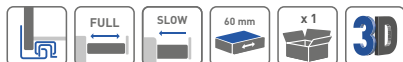

ELITE Schubladenbalken  
Poutre de tiroir ELITE  
Colgador de cajón ELITE

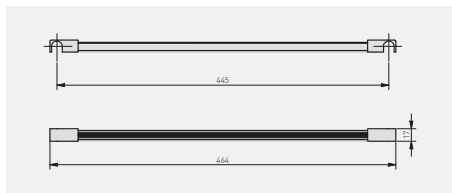

	Anzahl der Drähte nombre de fils número de rejillas	zusätzlicher Balken poutre supplémentaire colgador adicional	
WG-WSP0D60	6	WG-WSP0D-BAR-10 WG-WSP0D-BAR-60	Aluminium + Kunststoff aluminium + plastique aluminio + plástico
WG-WSP0D70	7		
WG-WSP0D80	8		
WG-WSP0D90	9		

Schrankstange, rechteckig  
Barre rectangulaire avec supports  
Barra rectangular con soportes

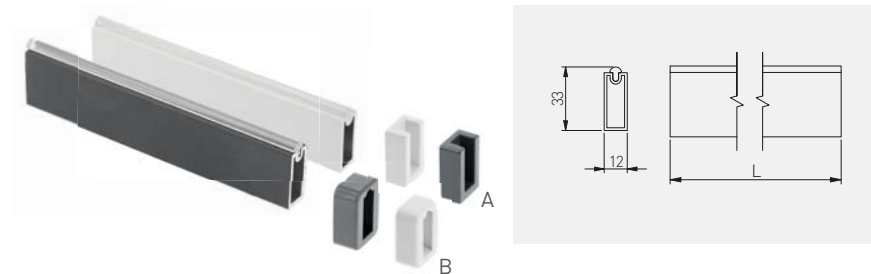

	L mm		
WG-RRPSET-A-10	3000	weiß / blanc / blanco	Aluminium + Kunststoff aluminium + plastique aluminio + plástico
WG-RRPSET-B-10			
WG-RRPSET-A-60		anthrazit / anthracite / antracita	
WG-RRPSET-B-60			



Rosette, rechteckig  
Rosette rectangulaire  
Soporte rectangular

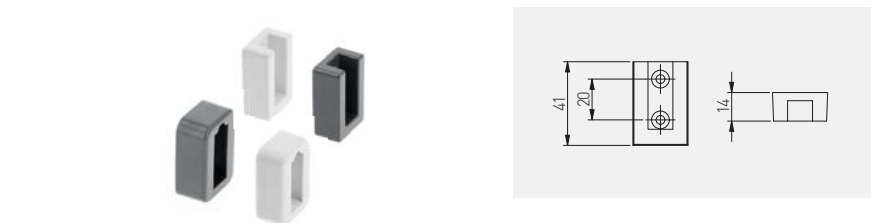

WG-RDRP-10				
WG-RDRP-60				
WG-RDRO-10				
WG-RDRO-60				



Kleiderlift mit Öldruckfeder  
 Penderie rabattable à huile  
 Pantógrafo con elevador de aceite

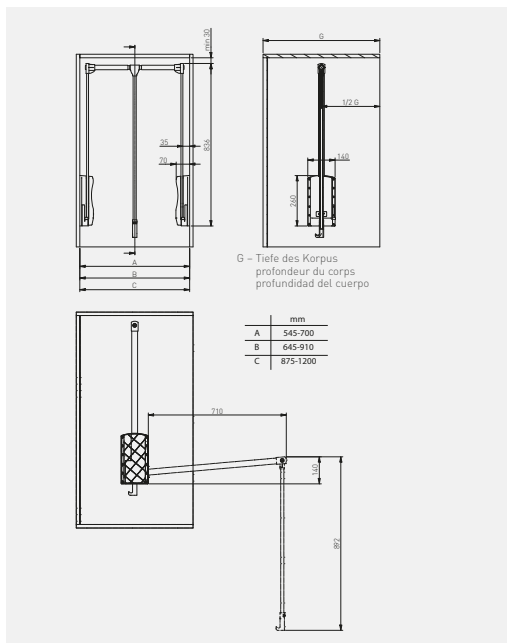







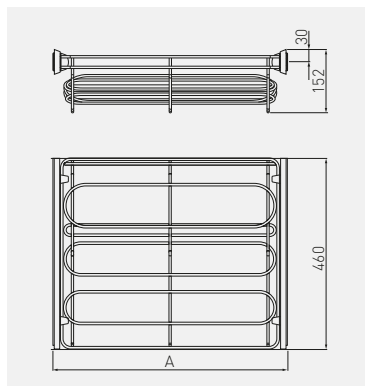

PG-ST83115-10A	875 - 1200	8	weiß blanc blanco	Stahl acier acero
PG-ST6083-10A	645 - 910			
PG-ST4560-10A	545 - 700			
PG-ST83115-60	875 - 1200		anthrazit, anthracite, antracita	
PG-ST6083-60	645 - 910			
PG-ST4560-60	545 - 700			





Schuhschublade SMART  
 Porte-chaussures SMART  
 Balda SMART para calzado



		 mm	 A	 min./max.		
W-WOBU60-BP-60	ohne Führungen jeu complet sans glissière juego sin guías	600	Vol- lauszug totale completa	560 – 568	grau, gris, gris	Stahl + Kunststoff, acier + plastique, acero + plástico,
W-WOBU70-BP-60	ohne Führungen jeu complet sans glissière juego sin guías	700		660 – 668		
W-WOBU80-BP-60	ohne Führungen jeu complet sans glissière juego sin guías	800		760 – 768		
W-WOBU90-BP-60	ohne Führungen jeu complet sans glissière juego sin guías	900		860 – 868		







A  
min./max.



		mm		A min./max.		
W-WOBU60-BP-10	ohne Führungen jeu complet sans glissière juego sin guías	600	Vol- lauszug totale completa	560 - 568	weiß blanc blanco	Stahl + Kunstst- off, acier + plastique, acero + plástico,
W-WOBU70-BP-10	ohne Führungen jeu complet sans glissière juego sin guías	700		660 - 668		
W-WOBU80-BP-10	ohne Führungen jeu complet sans glissière juego sin guías	800		760 - 768		
W-WOBU90-BP-10	ohne Führungen jeu complet sans glissière juego sin guías	900		860 - 868		



Hosenaufhänger SMART  
 Porte-pantalón SMART  
 Colgador SMART para pantalones

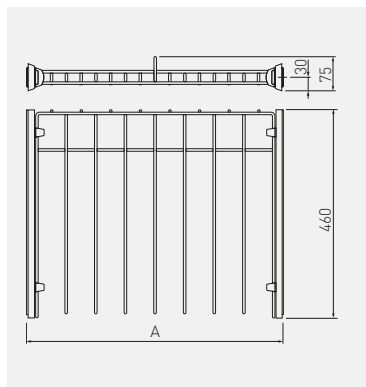

A  
min./max.



W-WSPD60-BP-60	ohne Führungen jeu complet sans glissière juego sin guías	600	560 – 568	Vol- lauszug totale com- pleta	grau, gris, gris	Stahl + Kunstst- off, acier + plastique, acero + plástico,
W-WSPD70-BP-60	ohne Führungen jeu complet sans glissière juego sin guías	700	660 – 668			
W-WSPD80-BP-60	ohne Führungen jeu complet sans glissière juego sin guías	800	760 – 768			
W-WSPD90-BP-60	ohne Führungen jeu complet sans glissière juego sin guías	900	860 – 868			





A  
min./max.



W-WSPD60-BP-10	ohne Führungen jeu complet sans glissière juego sin guías	600	Vol- lauszug totale com- pleta	560 – 568	weiß blanc blanco	Stahl + Kunststoff, acier + plastique, acero + plástico,
W-WSPD70-BP-10	ohne Führungen jeu complet sans glissière juego sin guías	700		660 – 668		
W-WSPD80-BP-10	ohne Führungen jeu complet sans glissière juego sin guías	800		760 – 768		
W-WSPD90-BP-10	ohne Führungen jeu complet sans glissière juego sin guías	900		860 – 868		



Wäschekorb SMART  
Panier à sous-vêtements coulissant SMART  
Cesto para ropa SMART

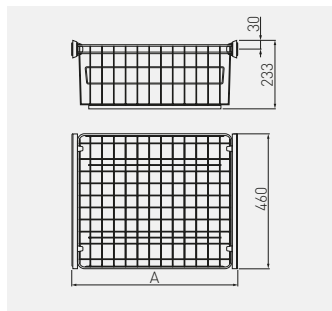

A  
min./max.



		mm		A min./max.		
W-WK060-BP-60	ohne Führungen jeu complet sans glissière juego sin guías	600	Vol- lauszug totale com- pleta	560 – 568	grau, gris, gris	Stahl + Kunststoff, acier + plas- tique, acero + plástico,
W-WK070-BP-60	ohne Führungen jeu complet sans glissière juego sin guías	700		660 – 668		
W-WK080-BP-60	ohne Führungen jeu complet sans glissière juego sin guías	800		760 – 768		
W-WK090-BP-60	ohne Führungen jeu complet sans glissière juego sin guías	900		860 – 868		





A  
min./max.







		mm		A min./max.		
W-WK060-BP-10	ohne Führungen jeu complet sans glissière juego sin guías	600		560 – 568		
W-WK070-BP-10	ohne Führungen jeu complet sans glissière juego sin guías	700		660 – 668		
W-WK080-BP-10	ohne Führungen jeu complet sans glissière juego sin guías	800	Vol- lauszug totale com- pleta	760 – 768	weiß blanc blanco	Stahl + Kunststoff, acier + plástico, acero + plástico,
W-WK090-BP-10	ohne Führungen jeu complet sans glissière juego sin guías	900		860 – 868		

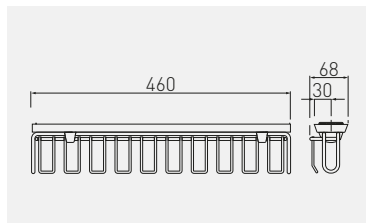

Krawatten- und Gürtelaufhänger SMART  
 Porte-cravates et ceintures SMART  
 Colgador SMART para cinturones y corbatas









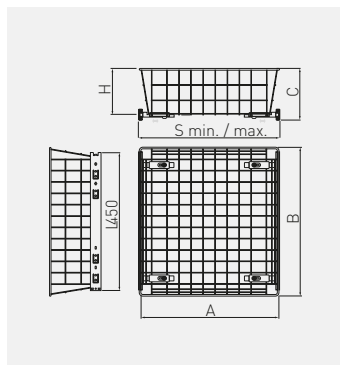



				
W-WKRP-BP-60	ohne Führungen jeu complet sans glissière juego sin guías	Vollauszug totale completa	grau, gris, gris	Stahl + Kunststoff, acier + plastique, acero + plástico,
W-WKRP-VE-60	mit Kugelführungen H45 mit Dämpfung sur glissière à billes H45 avec fonction de fermeture amortie con guía de bolas H45 con función de cierre silencioso n			
W-WKRP-BP-10	ohne Führungen jeu complet sans glissière juego sin guías		weiß blanc blanco	
W-WKRP-VE-10	mit Kugelführungen H45 mit Dämpfung sur glissière à billes H45 avec fonction de fermeture amortie con guía de bolas H45 con función de cierre silencioso n			



Schrankkorb  
Panier d'armoire  
Cesta del armario







	 H mm	 mm	 A mm	 B mm	 C mm	 S min/max			
KO-SR100-30-10	300	100	255	485	123	260-285	verzinkt galvanisé galvanizado	weiß blanc blanco	Stahl + Kunststoff, acier + plas- tique, acero + plástico,
KO-SR100-40-10	400	100	355	485	123	360-385			
KO-SR100-50-10t	500	100	455	485	123	460-485			
KO-SR100-60-10	600	100	555	485	123	560-585			
KO-SR150-30-10	300	150	255	485	173	260-285			
KO-SR150-40-10	400	150	355	485	173	360-385			
KO-SR150-50-10	500	150	455	485	173	460-485			
KO-SR150-60-10	600	150	555	485	173	560-585			
KO-SR200-30-10	300	200	255	485	223	260-285			
KO-SR200-40-10	400	200	355	485	223	360-385			
KO-SR200-50-10	500	200	455	485	223	460-485			
KO-SR200-60-10	600	200	555	485	223	560-585			

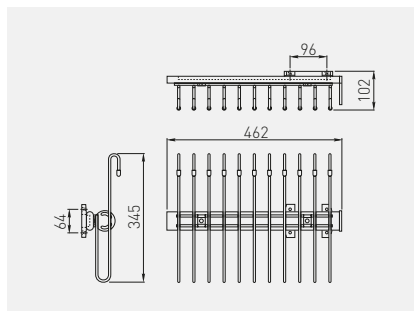

Produkt für die Montage auf H35, H45 Kugelführungen sowie Rollschubführungen - Set ohne Führungen  
Produit à monter sur des guides H35, H45 et à rouleaux - ensemble sans guides  
Producto para montar con guías H35, H45 y guías de rodillos - set sin guías





Ausziehbarer Hosenaufhänger  
 Porte-pantalons  
 Percha cuelga-pantalones en suspensión

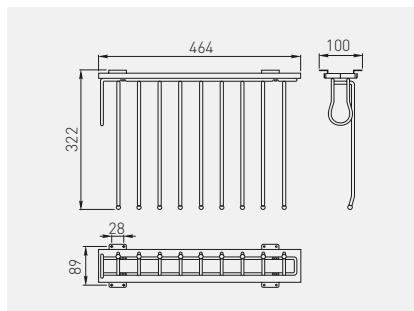

			
WW-WSP00-01	Teilauszug partielle parcial	Chrom, Aluminium, schwarz chrome, aluminium, noir cromado, aluminio, negro	Stahl, Aluminium, Kunststoff acier, aluminium, plastique acero, aluminio, plástico

Hosenaufhänger WS  
 Porte-pantalons WS  
 Percha WS para pantalones



				
WW-WSP00-01	rechts, droit, derecha	Teilauszug partielle parcial	Chrom, Aluminium, schwarz chrome, aluminium, noir cromado, aluminio, negro	Stahl, Aluminium, Kunststoff acier, aluminium, plastique acero, aluminio, plástico
WW-WSL00-01	links gauche izquierdo			



Kleiderbügelhalter WU  
 Porte- vêtements WU  
 Percha WU para ropa

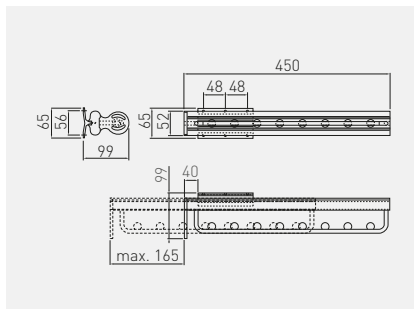

WW-WUBR00-01	Teilauszug partielle parcial	Chrom, Aluminium, schwarz chrome, aluminium, noir cromado, aluminio, negro	Stahl, Aluminium, Kunststoff acier, aluminium, plastique acero, aluminio, plástico





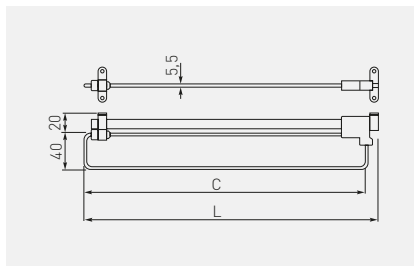



Kleiderbügelhalter WSL, ausziehbar  
 Suspension WSL  
 Percha WSL

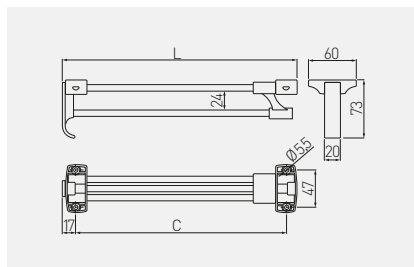

WW-WSL250-01	235	250	Chrom chrome cromado	Stahl acier acero
WW-WSL300-01	285	300		
WW-WSL350-01	335	350		
WW-WSL400-01	385	400		
WW-WSL450-01	435	450		
WW-WSL500-01	485	500		

Kleiderbügelhalter WSD, ausziehbar  
Suspension extensible WSD  
Percha extraíble WSD



	 C mm	 L mm		
WW-WSD250-01B	220	252	Chrom, schwarz chrome, noir cromado, negro	Stahl + Kunststoff, acier + plastique, acero + plástico,
WW-WSD300-01B	270	302		
WW-WSD350-01B	320	352		
WW-WSD400-01B	370	402		
WW-WSD450-01B	420	452		
WW-WSD500-01B	470	502		

Schuhschrankscharnier  
Charnière pour étagère à chaussures  
Bisagra para estante de calzado

NEW

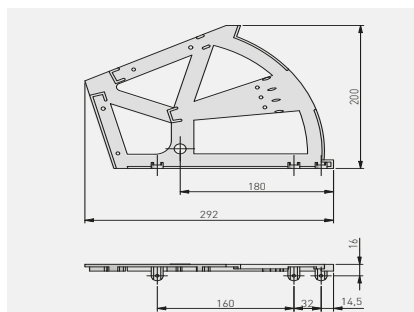

Anwendbar auf 12 mm Platte  
Utilisation pour panneaux de 12 mm  
Aplicable a placa de 12 mm

		
WW-ZWBUT2P-10	weiß / blanc / blanco	Kunststoff, plastique, plástico
WW-ZWBUT2P-20	schwarz / noir / negro	





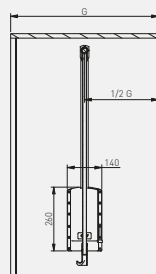
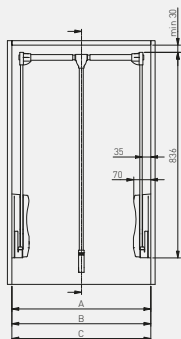

Kleiderlift mit Gasdruckfedern  
 Penderie rabattable à gaz  
 Pantógrafa con elevador por gas

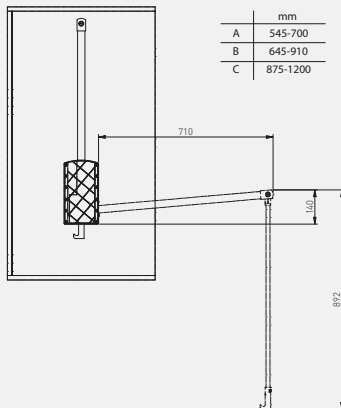

G - Tiefe des Korpus  
 profondeur du corps  
 profundidad del cuerpo







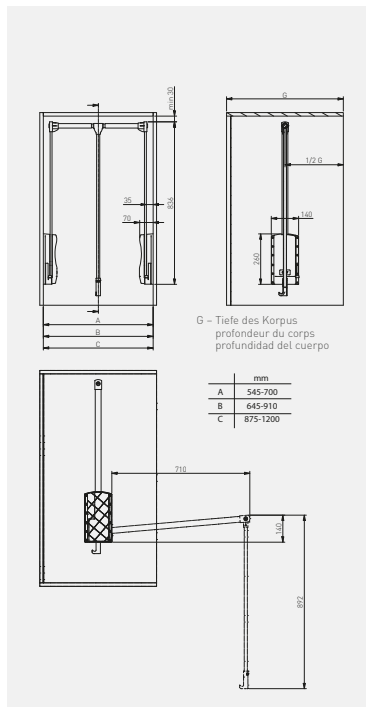

	mm
A	545-700
B	645-910
C	875-1200

					
PG-GA4560-10	545 - 700	12		weiß blanc blanco	Stahl + Kunststoff, acier + plastique, acero + plástico,
PG-GA6083-10	645 - 910				
PG-GA83115-10	875 - 1200				
PG-GA4560-20	545 - 700				
PG-GA6083-20	645 - 910				
PG-GA8311520	875 - 1200				
				schwarz noir negro	



Kleiderlift mit Öldruckfeder  
 Penderie rabattable à huile  
 Pantógrafo con elevador de aceite



	 mm	 kg		
PG-AL4560-20	545 - 700	8	Aluminium / aluminium / aluminio	Aluminium + Kunststoff aluminium + plástico aluminio + plástico
PG-AL6083-20	645 - 910			
PG-AL8311520	875 - 1200			
PG-ST4560-10	545 - 700		weiß / blanc / blanco	Stahl + Kunststoff, acier + plastique, acero + plástico,
PG-ST4560-20			schwarz / noir / negro	
PG-ST6083-10	645 - 910		weiß / blanc / blanco	
PG-ST6083-20			schwarz / noir / negro	
PG-ST83115-10	875 - 1200		weiß / blanc / blanco	
PG-ST8311520		schwarz / noir / negro		





Abfallsammler PRACTI ECO 400  
 Poubelle recyclage PRACTI ECO 400  
 Cubo de basura con segregador PRACTI ECO 400

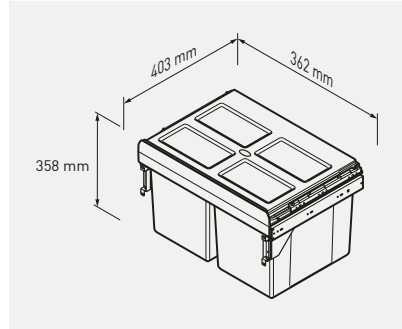

PB-45-400MF-2X16-60A

400

2 x 16 L

anthrazit,  
anthracite,  
antracita

Kunststoff / plastique / plástico



Abfallsammler PRACTI ECO 300  
 Poubelle recyclage PRACTI ECO 300  
 Cubo de basura con segregador PRACTI ECO 300



PB-45-0010X3-60A



PB-45-002010-60A

Mit Kugelführungen mit Dämpfung  
 Sur glissières à billes H=45 avec fermeture amortie  
 Sobre guía de bolas H45 con cierre silencioso

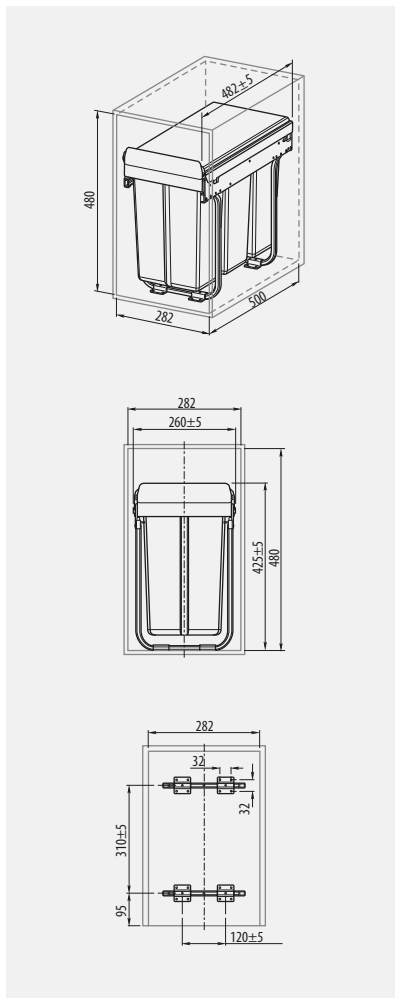

		 mm			
PB-45-0010X3-60A		300	3 x 10 L	anthrazit, anthracite, antracita	Kunststoff / plastique / plástico
PB-45-002010-60A		300	10 L, 20 L		



Abfallsammler PRACTI ECO 400  
 Poubelle recyclage PRACTI ECO 400  
 Cubo de basura con segregador PRACTI ECO 400









PB-45-002X20-60A

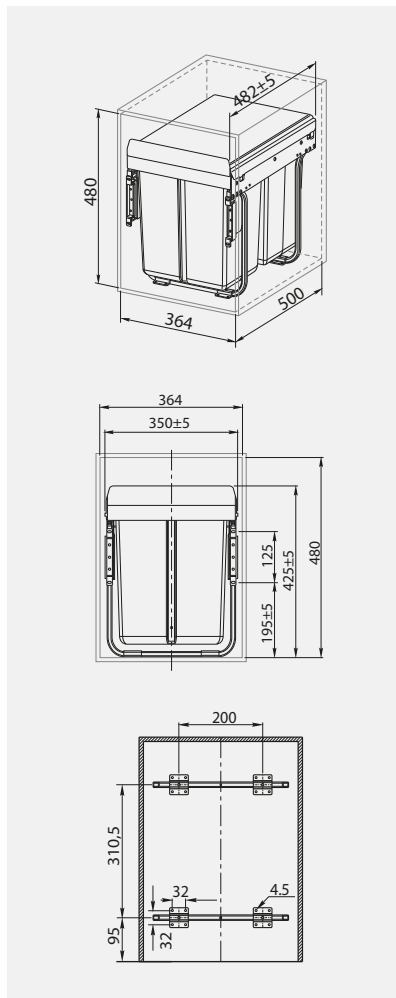

PB-45-202X10-60A

Mit Kugelführungen mit Dämpfung  
 Sur glissières à billes H=45 avec fermeture amortie  
 Sobre guía de bolas H45 con cierre silencioso



		 mm			
PB-45-002X20-60A		400	2 x 20 L	anthrazit, anthracite, antracita	Kunststoff / plastique / plástico
PB-45-202X10-60A		400	20 L, 2 x 10 L		





Abfallsammler PRACTI ECO 400 mit Frontenbefestigung  
 Poubelle recyclage PRACTI ECO 400 avec fixation frontale  
 Cubo de basura con segregador PRACTI ECO 400 con fijación frontal



PB-45-MF002X20-60A



PB-45-MF202X10-60A

Mit Kugelführungen mit Dämpfung  
 Sur glissières à billes H=45 avec fermeture amortie  
 Sobre guía de bolas H45 con cierre silencioso

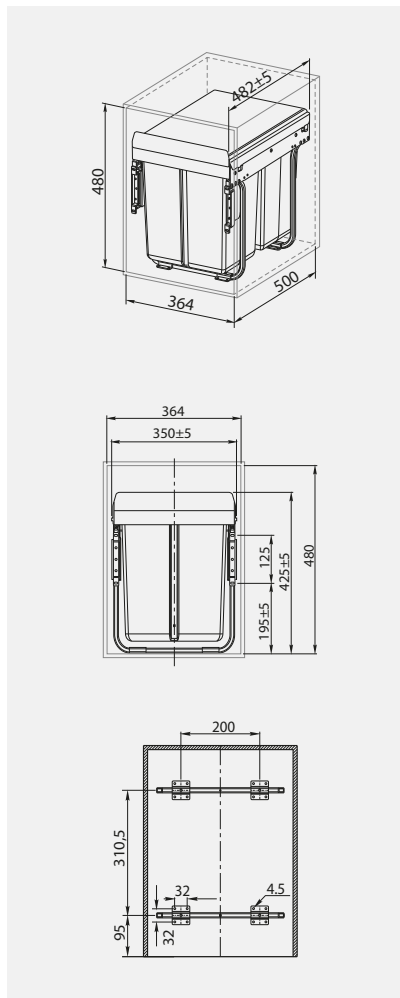

PB-45-MF002X20-60A	400	2 x 20 L	anthrazit, anthracite, antracita	Kunststoff / plastique / plástico
PB-45-MF202X10-60A		20 L, 2 x 10 L		



Abfallsammler PRACTI ECO 450 niedrig  
 Poubelle recyclage PRACTI ECO 450 série basse  
 Cubo de basura con segregador PRACTI ECO 450 bajo



PB-45-002X15-60A

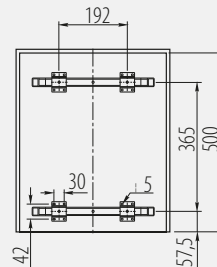
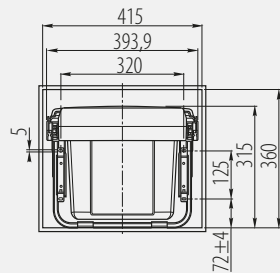
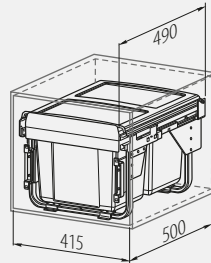

Mit Kugelführungen mit Dämpfung  
 Sur glissière avec fermeture amortie  
 Sobre guía con cierre silencioso



PB-45-002X15-60A	450	2 x 15 L	anthrazit, anthracite, antracita	Kunststoff / plastique / plástico
------------------	-----	----------	--	-----------------------------------



Abfallsammler PRACTI ECO 450 niedrig mit Frontenbefestigung  
 Poubelle recyclage PRACTI ECO 450 série basse avec fixation frontale  
 Cubo de basura con segregador PRACTI ECO 450 bajo con fijación frontal



PB-45-MF2X15-60A

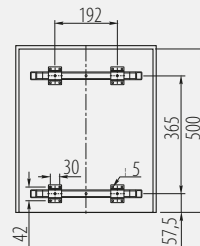
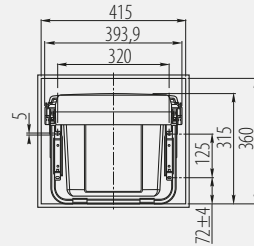
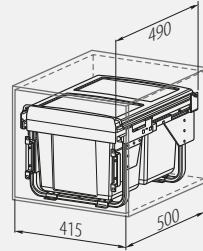

Mit Kugelführungen mit Dämpfung  
 Sur glissière avec fermeture amortie  
 Sobre guía con cierre silencioso



PB-45-MF2X15-60A

450

2 x 15 L

anthrazit,  
anthracite,  
antracita

Kunststoff / plastique / plástico



Abfallsammler PRACTI ECO 450 hoch  
 Panier de déchets ségrégation PRACTI ECO 450 haut  
 Cubo de basura con segregador PRACTI ECO 450 alto



PB-45-450-2X20-60A



PB-45-0202X10-60A

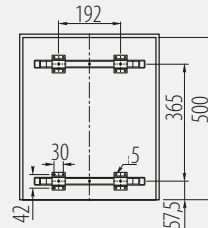
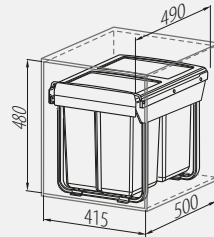
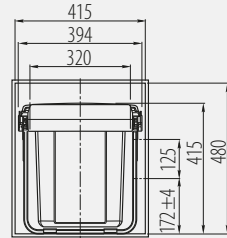

Mit Kugelführungen mit Dämpfung  
 Sur glissière avec fermeture amortie  
 Sobre guía con cierre silencioso



PB-45-450-2X20-60A	450	2 x 20 L	anthrazit, anthracite, antracita	Kunststoff / plastique / plástico
PB-45-0202X10-60A		20 L, 2 x 10 L		



Abfallsammler PRACTI ECO 450 hoch mit Frontenbefestigung  
 Panier de déchets ségrégation PRACTI ECO 450 haute avec fixation frontale  
 Cubo de basura con segregador PRACTI ECO 450 alto con fijación frontal



PB-45-450MF202X10-60A



PB-45-MF2X20-60A

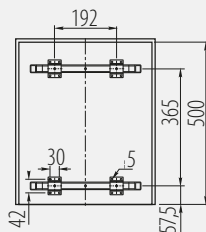
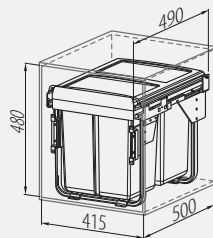
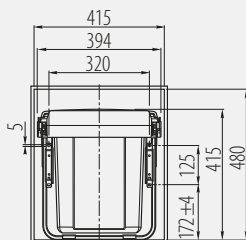

Mit Kugelführungen mit Dämpfung  
 Sur glissière avec fermeture amortie  
 Sobre guía con cierre silencioso



PB-45-450MF202X10-60A	450	20 L, 2 x 10 L	anthrazit, anthracite, antracita	Kunststoff / plastique / plástico
PB-45-MF2X20-60A		2 x 20 L		



Abfallsammler PRACTI ECO 600 hoch mit Frontenbefestigung  
 Poubelle de cuisine PRACTI ECO 600 haut avec fixation frontale  
 Cubo de basura con segregador PRACTI ECO 600 alto con fijación frontal



PB-45-MF342X17-60A



PB-45-MF2X34-60A

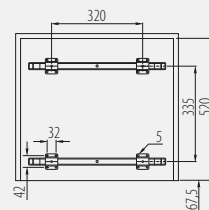
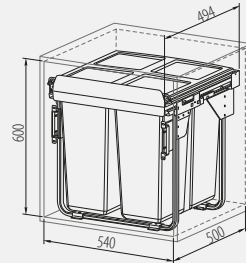
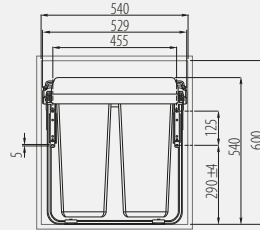

Mit Kugelführungen mit Dämpfung  
 Sur glissière avec fermeture amortie  
 Sobre guía con cierre silencioso



PB-45-MF342X17-60A	600	34 L, 2 x 17 L	anthrazit, anthracite, antracita	Kunststoff / plastique / plástico
PB-45-MF2X34-60A		2 x 34 L		



Abfallsammler PRACTI ECO 600  
 Poubelle recyclage PRACTI ECO 600  
 Cubo de basura con segregador PRACTI ECO 600

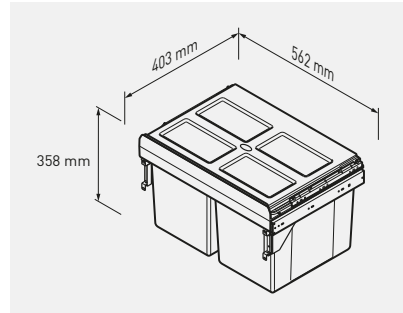

PB-45-600MF-2X27-60A	600	2 x 27 L	anthrazit, anthracite, antracita	Kunststoff / plastique / plástico
----------------------	-----	----------	--	-----------------------------------



Abfallsammler AXISPACE  
 Poubelle de cuisine AXISPACE  
 Cubo de basura con segregador AXISPACE



PB-AS-600-1X15L-2X7L	600	1 x 15 L, 2 x 7 L	anthrazit, anthracite, antracita	Kunststoff mit Graphenpartikeln* matière plastique avec particules de graphène* Plástico con partículas de grafeno*		
PB-AS-600-1X15L-3X7L		1 x 15 L, 3 x 7 L				
PB-AS-600-2X15L		2 x 15 L				
PB-AS-600-2X15L-2X7L		2 x 15 L, 2 x 7 L				
PB-AS-700-2X15L-2X7L	700	2 x 15 L, 2 x 7 L				
PB-AS-800-2X15L-2X7L	800	2 x 15 L, 2 x 7 L				
PB-AS-800-4X15L		4 x 15 L				
PB-AS-900-4X15L		900			4 x 15 L	



\*Graphen ist ein Nanomaterial aus Kohlenstoff mit antibakterieller und antimykotischer Wirkung. Er ist in der Lage, innerhalb von 120 Minuten bis zu 99 % der Mikroorganismen von seiner Oberfläche zu eliminieren.  
 Le graphène est un nanomatériau composé de carbone aux propriétés antibactériennes et antifongiques. Il est capable d'éliminer jusqu'à 99 % des micro-organismes de sa surface en 120 min.  
 El grafeno es un nanomaterial formado por carbono con propiedades antibacterianas y antifúngicas. Es capaz de eliminar hasta el 99% de los microorganismos de su superficie en 120 minutos.



## Abfallsammler MULTINO Poubelle de cuisine MULTINO Cubo de basura con segregador MULTINO

Für Schubladen Modern Box / Axis Pro  
Dédié aux tiroirs Modern Box / Axis Pro  
Diseñado para cajones Modern Box / Axis Pro

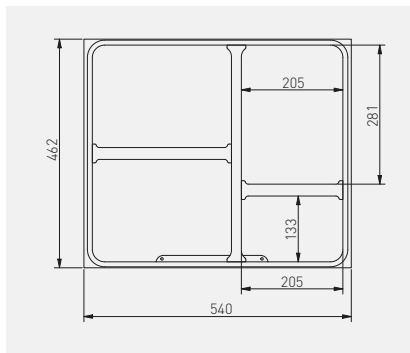

	 mm			
PB-93004162601	540	3 x 15 L, 1 x 7 L	anthrazit, anthracite, antracita	Kunststoff, plastique, plástico



## Eimer CIRCA Panier de déchets ségrégation CIRCA Cubo CIRCA

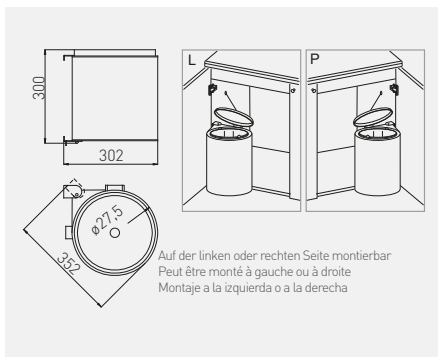





			
PB-91024160V	11 L	grau / gris / gris	Kunststoff / plastique / plástico

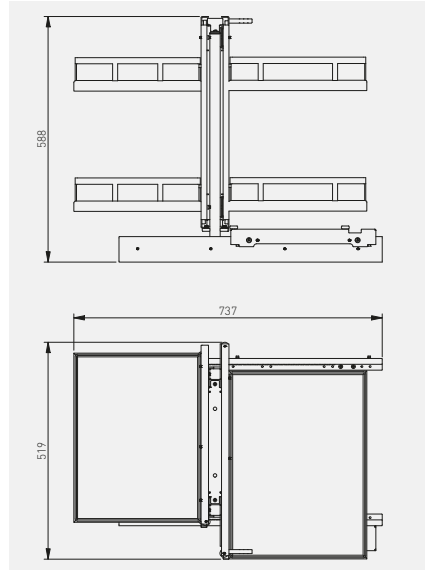

MovixPro Corner 450/500  
 Corner MovixPro 450/500  
 Esquinero MovixPro 450/500

NEW



		 mm		
KO-WMC450-60		450	anthrazit, anthracite, antracita	Stahl acier acero
KO-WMC450-01B			chrom + weiß matt, chrome + blanc mat, cromado + alfombrilla blanca	
KO-WMC450-01			chrom + anthrazit matt, chrome + anthracite mat, cromado + alfombrilla antracita	
KO-WMC500-60		500	anthrazit, anthracite, antracita	
KO-WMC500-01B			chrom + weiß matt, chrome + blanc mat, cromado + alfombrilla blanca	
KO-WMC500-01			chrom + anthrazit matt, chrome + anthracite mat, cromado + alfombrilla antracita	



MovixPro Corner 450  
 Corner MovixPro 450  
 Esquinero MovixPro 450

NEW

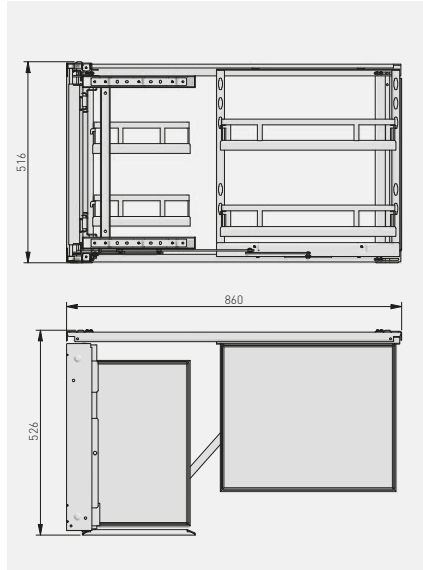







KO-UMC450-60	anthrazit, anthracite, antracita	Stahl acier acero
KO-UMC450-01B	chrom + weiß matt, chrome + blanc mat, cromado + alfombrilla blanca	
KO-UMC450-01	anthrazit, anthracite, antracita	

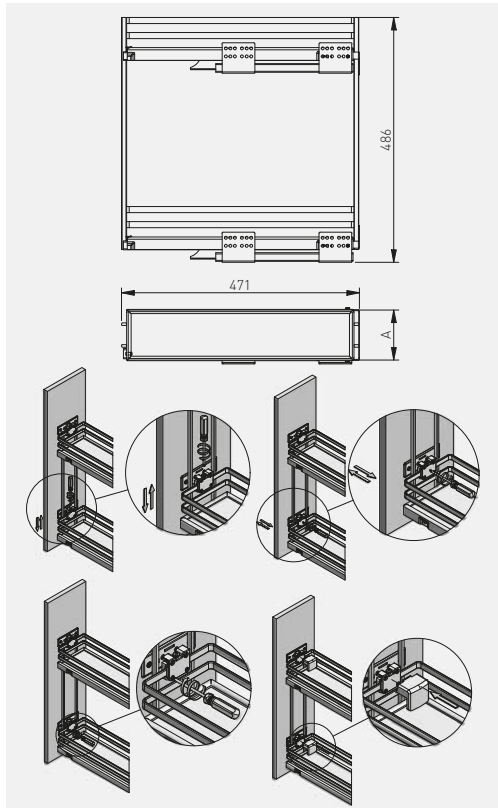

Ausziehbares Cargo-Regal, Organizer für Schrank MOVIX PRO  
 Panier latéral MOVIX PRO  
 Cestillo lateral sobre guías de montaje inferior MOVIX PRO

NEW



	 mm			
KO-150BO-60	150	verzinkt galvanisé galvanizado	anthrazit, anthracite, antracita	Stahl acier acero
KO-200BO-60	200			
KO-150BO-01	150			
KO-200BO-01	200		chrom + anthrazit matt, chrome + anthracite mat, cromado + alfombrilla antracita	
KO-150BO-01B	150		chrom + weiß matt, chrome + blanc mat, cromado + alfombrilla blanca	
KO-200BO-01B	200			



- \* Das Produkt enthält keine Führungen.  
Komplementäre Produkte: für die Schrankgrößen 150, 200 mm - Führungen mit Soft Close System: PB-K0450BO-L1, PB-K0450BO-R1.
- \* Le produit ne comprend pas de guides.
- \* Produits complémentaires: pour les tailles d'armoires 150, 200 mm - guides à fermeture silencieuse PB-K0450BO-L1, PB-K0450BO-R1.
- \* El producto no contiene guías.
- \* Productos complementarios: para armarios de 150, 200 mm - guías de cierre silencioso PB-K0450BO-L1, PB-K0450BO-R1.



Ausziehbares Cargo-Regal, Organizer für Schrank MOVIX PRO  
 Panier latéral MOVIX PRO  
 Cestillo lateral sobre guías de montaje inferior MOVIX PRO

NEW

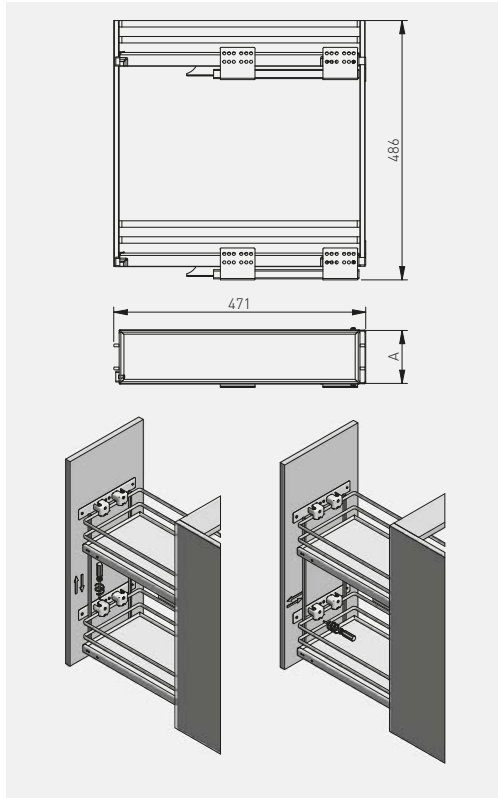

Code	Height (mm)	Material	Finish	Material
KO-300BO-60	300	verzinkt galvanisé galvanizado	anthrazit, anthracite, antracita	Stahl acier acero
KO-400BO-60	400			
KO-500BO-60	500			
KO-300BO-01	300		chrom + anthrazit matt, chrome + anthracite mat, cromado + alfombrilla antracita	
KO-400BO-01	400			
KO-500BO-01	500			
KO-300BO-01B	300		chrom + weiß matt, chrome + blanc mat, cromado + alfombrilla blanca	
KO-400BO-01B	400			
KO-500BO-01B	500			





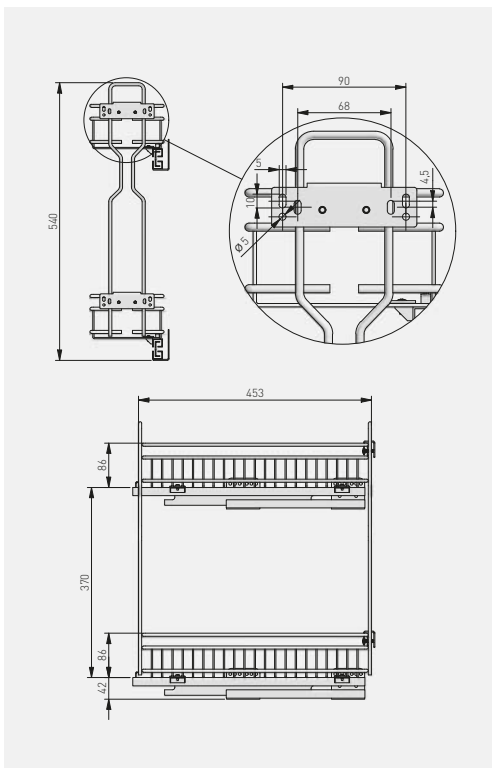
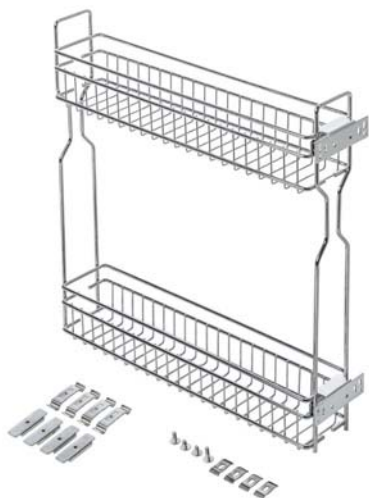

- \* Das Produkt enthält keine Führungen.  
Komplementäre Produkte: für die Schrankgrößen 300, 400, 500 mm - Führungen mit Soft Close System: PB-KO450BO.
- \* Le produit ne comprend pas de guides.  
Produits complémentaires: pour les tailles d'armoire 300, 400, 500 mm – guides à fermeture silencieuse PB-KO450BO.
- \* El producto no contiene guías.  
Productos complementarios: para armarios de 300, 400, 500 mm – guías de cierre silencioso PB-KO450BO.

Ausziehbares Cargo-Regal, Organizer für Schrank MOVIX  
 Panier latéral MOVIX  
 Cestillo lateral sobre guías de montaje inferior MOVIX

NEW







	 mm		
KO-150B0-E-01	150	Chrom chrome cromado	Stahl acier acero
KO-200B0-E-01	200		



- \* Das Produkt enthält keine Führungen.  
Komplementäre Produkte: Führungen mit Soft Close System: PB-K0450B0-E-L PB-K0450B0-E-R.
- \* Le produit ne comprend pas de guides.  
Produits complémentaires: guides à fermeture silencieuse PB-K0450B0-E-L PB-K0450B0-E-R.
- \* El producto no contiene guías.  
Productos complementarios: guías de cierre silencioso PB-K0450B0-E-L PB-K0450B0-E-R.

Führungen mit Soft Close System für Cargo Movix Pro 150 und 200  
 Coulisses Soft Close pour Cargo Movix Pro en 150 et 200 mm  
 Guías con cierre suave para cargos Movix Pro 150 y 200



			
PB-K0450B0-L1	x2	Chrom chrome cromado	Stahl acier acero
PB-K0450B0-R1	x2		

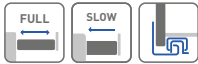

PB-K0450B0-L1

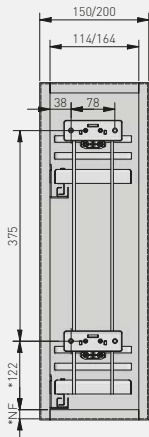



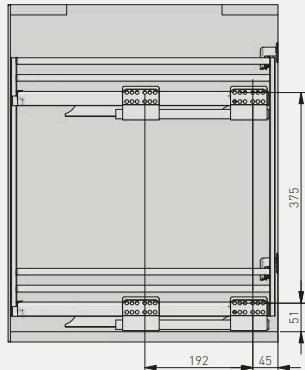
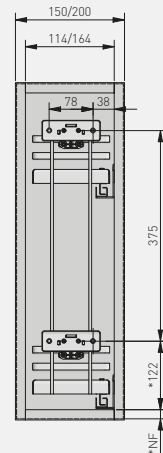

PB-K0450B0-R1





Führungen mit Soft Close System für Cargo Movix Pro 300, 400 und 500  
 Coulisses Soft Close pour Cargo Movix Pro en 300, 400 et 500 mm  
 Guías con cierre suave para cargos Movix Pro 300, 400 y 500





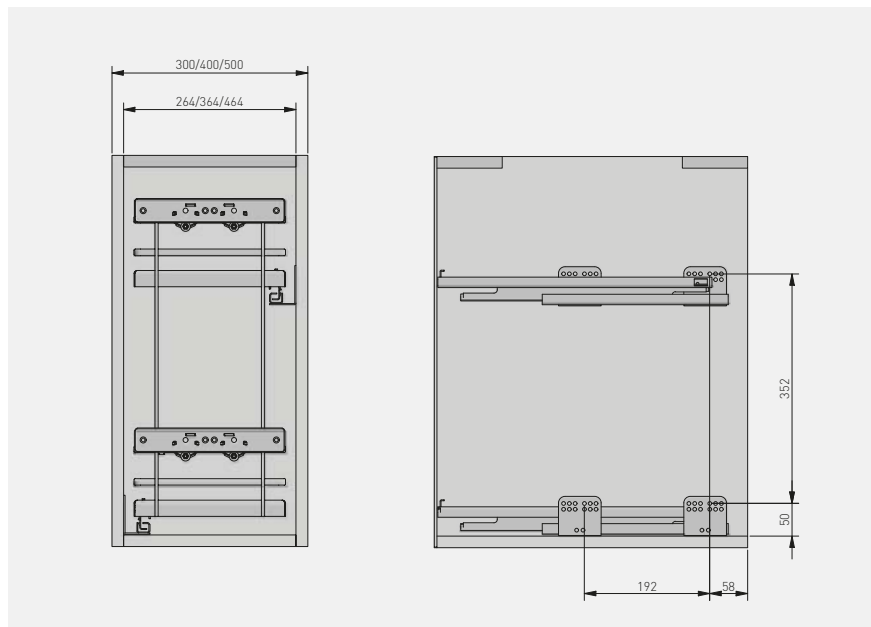

			
PB-K0450B0	x2	Chrom chrome cromado	Stahl acier acero



Führungen mit Soft Close System für Cargo Movix 150 und 200  
 Coulisses Soft Close pour Cargo Movix en 150 et 200 mm  
 Guías con cierre suave para cargos Movix 150 y 200



			
PB-KO450B0-E-L	x2	Chrom chrome cromado	Stahl acier acero
PB-KO450B0-E-R	x2		

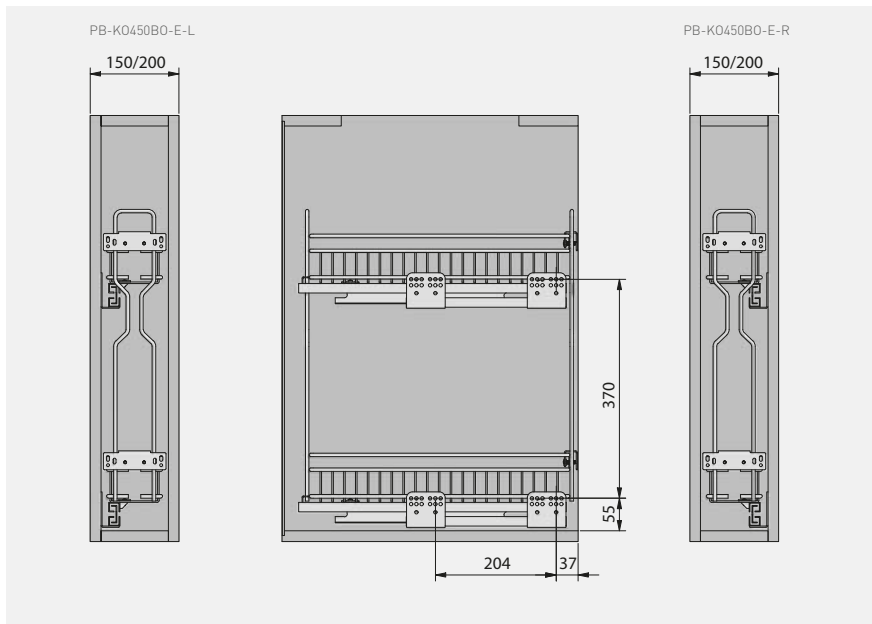

Geschirrtrockner, zwei Etagen, zur Montage im Schrank  
 Égouttoir à deux niveau pour l'assemblage  
 Escurridor de dos niveles para montar



OC-A0150-06	Edelstahl optik, acier brossé, acero pulido	Edelstahl acier inoxydable acero inoxidable
OC-A0160-06		
OC-A0170-06		
OC-A0180-06		
OC-A0190-06		

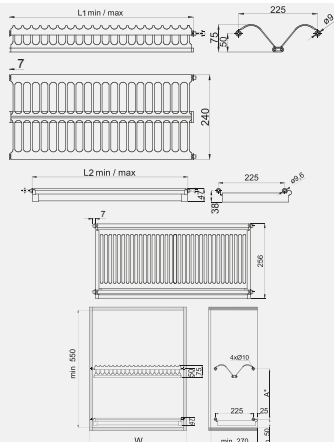

A\* Abmessung abhängig von Schrankhöhe und geplanter Ausstattung (z.B. A=275 mm)  
 La dimension A\* dépend de la hauteur de l'armoire et de l'utilisation prévue (par ex. A=275 mm)  
 La dimension A\* depende de la altura del mueble y del uso previsto (p. ej. A=275 mm)

L min./max.	W min./max.
430/480	450/475
530/580	550/575
630/680	650/675
730/780	750/775
830/880	850/875

Geschirrtrockner, eine Etage, zur Montage im Schrank  
 Égouttoir à un seul niveau pour assemblage  
 Escurridor de un nivel para montar



OC-A0660-06	Edelstahl optik, acier brossé, acero pulido	Edelstahl acier inoxydable acero inoxidable
OC-A0680-06		

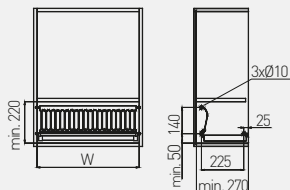
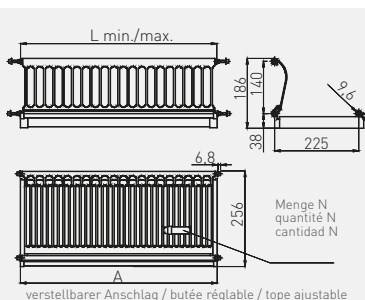

L min./max.	L min./max.	N
530/580	550/575	6
730/780	750/775	8

Geschirrtrockner, zwei Etagen, zur Montage im Schrank  
 Égouttoir à deux niveau pour assemblage  
 Escurridor de dos niveles para montar



		 LW mm	 mm		
OC-2PV340-02-18	für Platte 18 mm, pour plaque 18 mm, para placa de 18 mm	364	400	Chrom chrome cromado	Edelstahl + Kunststoff, acier inoxydable + plastique, acero inoxidable + plástico
OC-2PV345-02-18		414	450		
OC-2PV350-02-18		464	500		
OC-2PV360-02-18		564	600		
OC-2PV360-02-18A*		564	600		
OC-2PV370-02-18		664	700		
OC-2PV380-02-18		764	800		
OC-2PV380-02-18A*		764	800		
OC-2PV390-02-18	864	900			

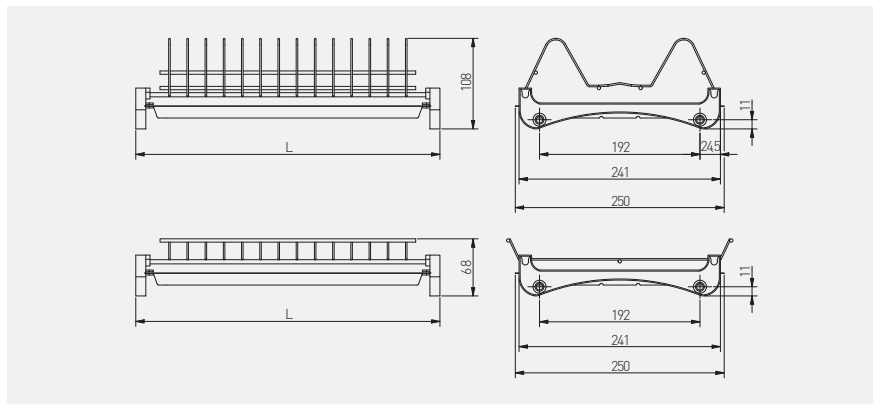



Geschirrtrockner A04, zwei Etagen, freistehend  
 Égouttoir à deux niveaux A04, autoportant  
 Escurridor de dos niveles A04, libre colocación

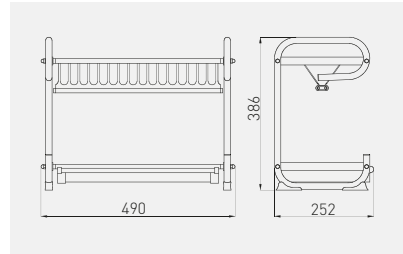

OC-A0450-06

Edelstahl optik,  
acier brossé,  
acero pulidoEdelstahl  
acier inoxydable  
acero inoxidable

Geschirrtrockner A03, zwei Etagen, freistehend  
 Égouttoir à deux niveaux A03, autoportant  
 Escurridor de dos niveles A03, libre colocación

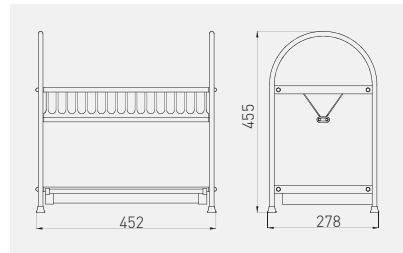

OC-A0350K-06

Edelstahl optik,  
acier brossé,  
acero pulidoEdelstahl  
acier inoxydable  
acero inoxidable

Geschirrtrockner mit Sortierer, zwei Etagen, freistehend  
 Égouttoir à deux niveaux avec organisateur, autoportant  
 Escurridor de dos niveles con cubertero, libre colocación

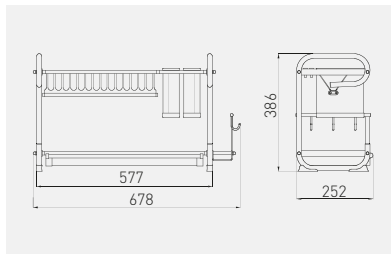

OC-A0460D-06

Edelstahl optik,  
acier brossé,  
acero pulidoEdelstahl  
acier inoxydable  
acero inoxidable

Geschirrtrockner, gerollt  
 Égouttoir enroulable  
 Escurridor enrollable

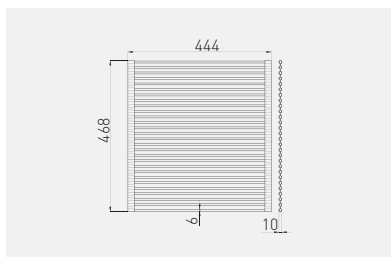
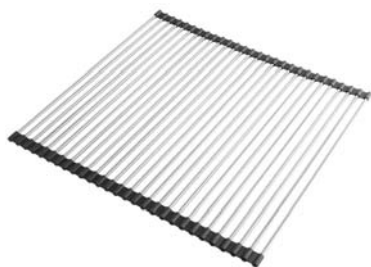

OC-E0707D-CZ

gebürsteter Stahl, schwarz  
acier brossé, noir  
acero pulido, negroEdelstahl  
acier inoxydable  
acero inoxidable

Tastaturablage mit Kugelführungen H27  
 Tablette coulissante pour clavier 27 mm  
 Bandeja para teclado con guía de bolas 27 mm

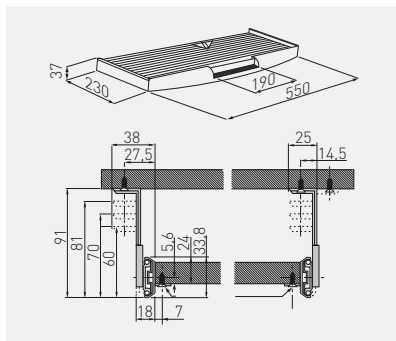

PU-KEY027-20	schwarz / noir / negro	Kunststoff plastique plástico
PU-KEY027-60	grau / gris / gris	



Tastaturablage mit Mousepad  
 Tablette de clavier avec tapis de souris  
 Bandeja para teclado con alfombrilla para ratón

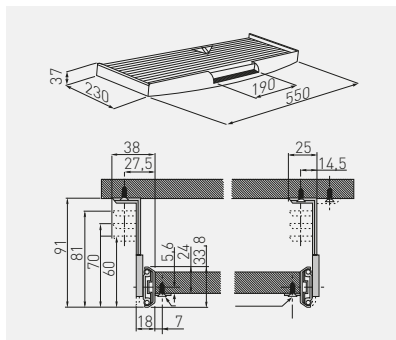

PU-KEYM27-20	schwarz / noir / negro	Kunststoff plastique plástico
PU-KEYM27-60	grau / gris / gris	





Computerwagen  
 Chariot d'ordinateur  
 Base para ordenador con ruedas

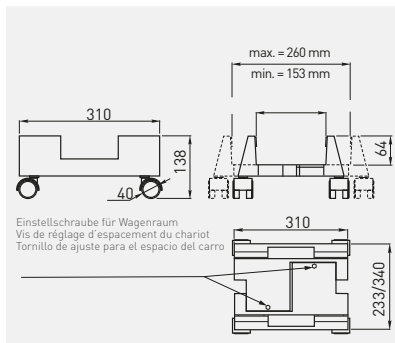

PU-PKO-00-20	schwarz / noir / negro	Kunststoff plástico
PU-PKO-00-60	grau / gris / gris	



USB-Hub mit 4 Anschlüssen  
 Hub - 4 ports USB  
 Hub -4 puertos USB

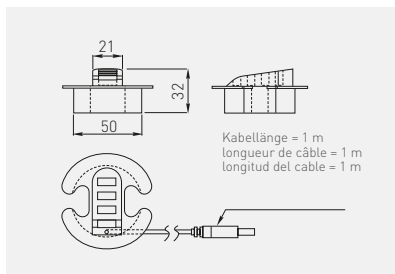

HB-USB-4X-60	silberfarben / argent / plata	Kunststoff plástico
--------------	-------------------------------	------------------------



Kabeldurchführung MERIDA 80  
 Passe câble MERIDA 80  
 Pasacables MERIDA 80

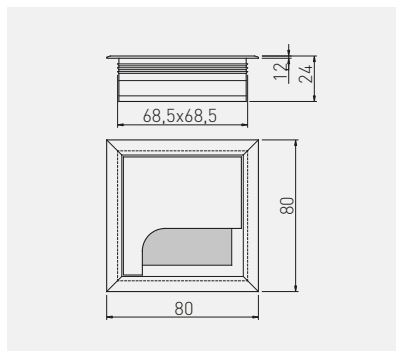

LB-K80X80-05	80 x 80	Aluminium / aluminium / aluminio	Aluminium aluminium aluminio
LB-K80X80-20		schwarz / noir / negro	



Kabeldurchführung MERIDA 100  
 Passage câble MERIDA 100  
 Pasacables MERIDA 100

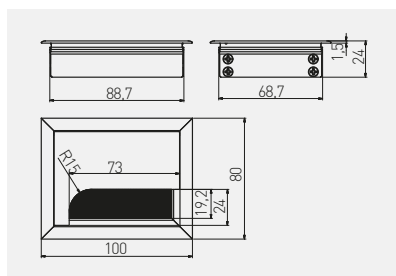

LB-80X100-05	80 x 100	Aluminium / aluminium / aluminio	Aluminium aluminium aluminio
LB-80X100-20		schwarz / noir / negro	



Kabeldurchführung MERIDA 160  
 Passe câble MERIDA 160  
 Pasacables MERIDA 160

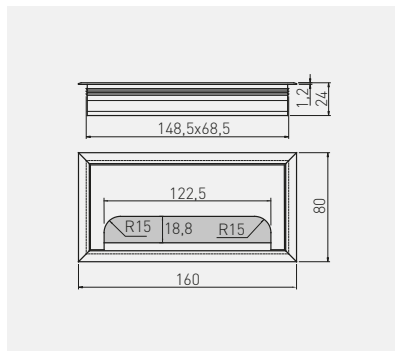

			
LB-80X160-05	80 x 160	Aluminium / aluminium / aluminio	Aluminium aluminium aluminio
LB-80X160-20		schwarz / noir / negro	



Kabeldurchführung MERIDA 280  
 Passage câble MERIDA 280  
 Pasacables MERIDA 280

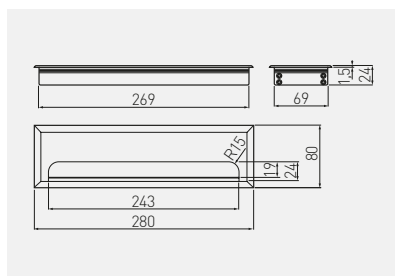

			
LB-80X280-05	80 x 280	Aluminium / aluminium / aluminio	Aluminium aluminium aluminio
LB-80X280-20		schwarz / noir / negro	



Kabeldurchführung MERIDA  
 Passe câble MERIDA  
 Pasacables MERIDA

NEW

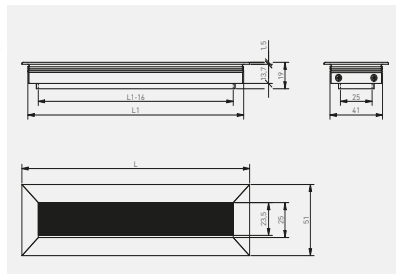
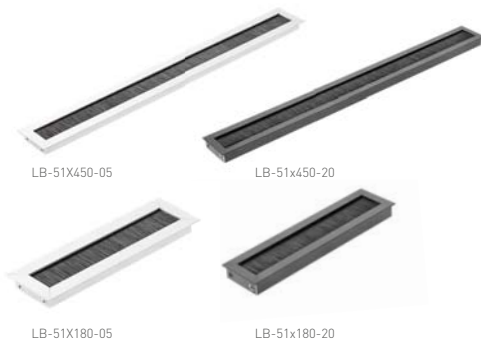

L mm	L1 mm	Aluminium aluminium aluminio	schwarz noir negro	
180	170	-	LB-51x180-20	Aluminium + Kunststoff aluminium + plastique aluminio + plástico
180	170	LB-51X180-05	-	
450	440	-	LB-51x450-20	
450	440	LB-51X450-05	-	



Kabeldurchführung MERIDA 500  
 Passe câble MERIDA 500  
 Pasacables MERIDA 500

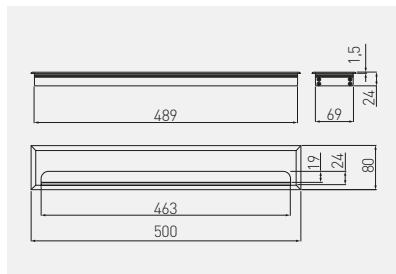





LB-80X500-05	80 x 500	Aluminium / aluminium / aluminio	Aluminium aluminium aluminio
LB-80X500-20		schwarz / noir / negro	

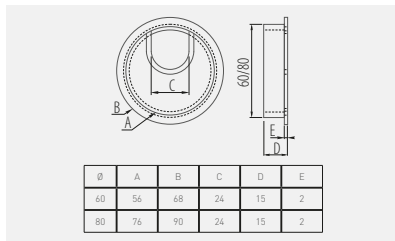

Metall-Kabeldurchführung  
Passage câble LBF  
Pasacables LBF



		 mm		
PM-LBF160-01		60	Chrom / chrome / cromado	ZnAl
PM-LBF160-02			Nickel matt / satiné / satinado	
PM-LBF160-05			Aluminium / aluminium / aluminio	
PM-LBF160-06			Edelstahl optik / acier brossé / acero pulido	
PM-LBF160-20M		schwarz matt / noir mat / negro mate		
PM-LBF180-01		80	Chrom / chrome / cromado	
PM-LBF180-02			Nickel matt / satiné / satinado	
PM-LBF180-05			Aluminium / aluminium / aluminio	
PM-LBF180-06			Edelstahl optik / acier brossé / acero pulido	
PM-LBF180-20M			schwarz matt / noir mat / negro mate	



Kunststoff-Kabeldurchführung  
Passe câble PLF  
Pasacables PLF

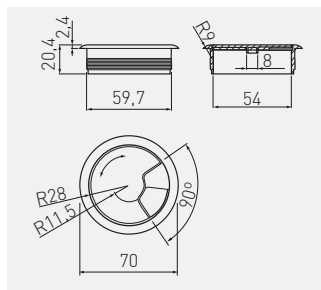

			
PM-PLF160-05		Aluminium / aluminium / aluminio	Kunststoff plastique plástico
PM-PLF160-10		weiß / blanc / blanco	
PM-PLF160-20		schwarz / noir / negro	
PM-PLF160-30		grau / gris / gris	
PM-PLF160-43		hellbraun / brun clair / marrón claro	
PM-PLF160-45		Nussbaum / noix / nogal	
PM-PLF160-47		Buche / hêtre / haya	
PM-PLF160-49		Ahorn / érable / křen j	
PM-PLF160-50		beige / beige / beige	
PM-PLF160-51		Calvados / calvados / calvados	



\*Produkt erhältlich auf individuelle Bestellung / Produit disponible sur demande / Producto disponible bajo demanda

Möbelschloss K-138  
Serrure K-138  
Cerradura K-138

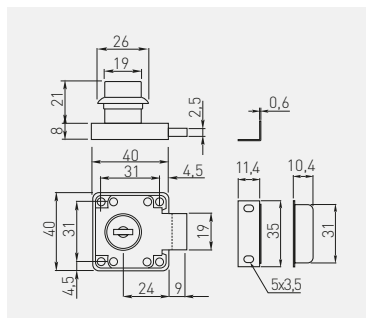

ZZ-KM-138-01-S



Chrom / chrome / cromado



ZnAl + Stahl / ZnAl + acier / ZnAl + acero

Möbelschloss Z-138 mit Klappschlüssel  
Serrure Z-138 avec clé pliante  
Cerradura Z-138 con llave plegable

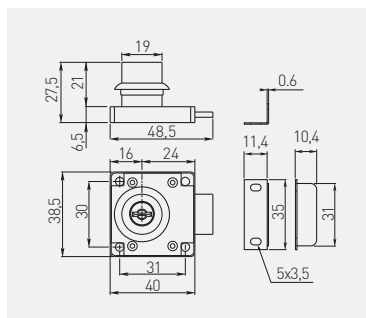

ZZ-ZN-138-01



Chrom / chrome / cromado



ZnAl + Stahl / ZnAl + acier / ZnAl + acero

Möbelschloss C-138 mit Digitalschlüssel  
 Serrure C-138 avec clé numérique  
 Cerradura C-138 con llave digital

Kompatibel mit dem Hauptschlüssel  
 Compatible avec la touche MASTER  
 Compatible con la llave MASTER

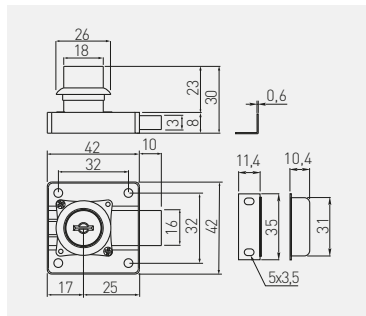

ZZ-CF-138-01



Chrom / chrome / cromado



ZnAl + Stahl / ZnAl + acier / ZnAl + acero

Hauptschlüssel für Möbelschloss C-138  
 Clé de fermeture MASTER C-138  
 Llave MASTER para la cerradura C-138



ZZ-KLMASTER



Chrom / chrome / cromado



ZnAl + Stahl / ZnAl + acier / ZnAl + acero

Fallenschloss Z-338  
 Serrure Z-338 avec boutons pression  
 Cerradura Z-338 a presión

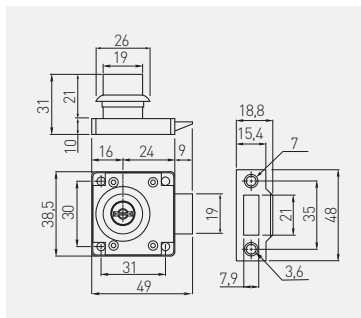

ZZ-ZN-338-01-S



Chrom / chrome / cromado



ZnAl + Stahl / ZnAl + acier / ZnAl + acero

Bolzenschloss B-105  
 Serrure de meuble B-105  
 Cerradura B-105 de bulón

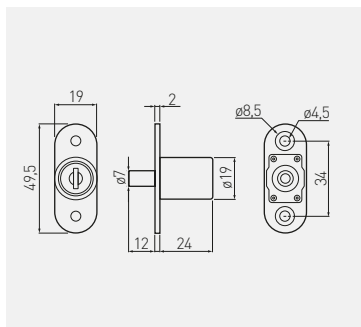

ZZ-B0-105-01-S



Chrom / chrome / cromado







ZnAl + Stahl / ZnAl + acier / ZnAl + acero

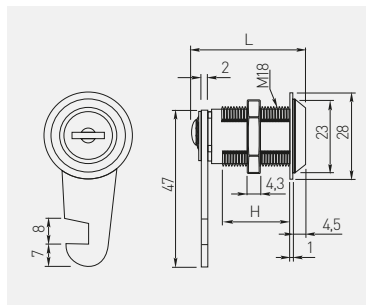

Kastenschloss Z-103  
 Serrure boîte Z-103  
 Cerradura Z-103 para mueble



		 L mm	 H mm		
ZZ-16-103-01-S		27	12	Chrom / chrome / cromado	ZnAl + Stahl / ZnAl + acier / ZnAl + acero
ZZ-20-103-01-S		30	16,5		
ZZ-30-103-01-S		40	26,5		

Glastürschloss S-409  
 Serrure S-409 pour vitres  
 Cerradura S-409 para vidrio

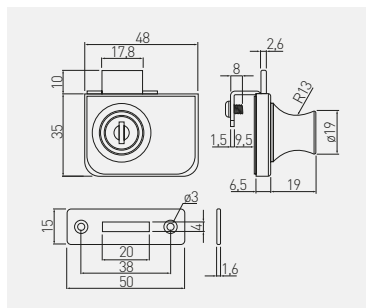

Bestimmt für 4 – 8 mm Glas  
 Utilisation pour verre de 4 – 8 mm  
 Compatible con vidrios de 4 – 8 mm

			
ZZ-SZ-409-01-S		Chrom / chrome / cromado	ZnAl + Stahl / ZnAl + acier / ZnAl + acero

Schloss M-201  
Serrure M-201  
Cerradura M-201

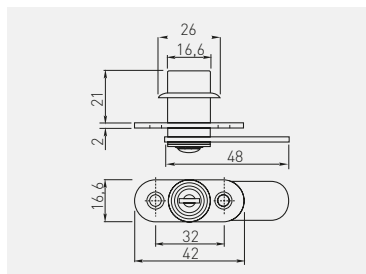

ZZ-M0-201-01-S



Chrom / chrome / cromado



Stahl + Kunststoff + ZnAl / acier + plastique + ZnAl / acero + plástico + ZnAl

Rollladen-Schloss Z-202  
Serrure Z-202 pour volets roulants  
Cerradura Z-202 pico de loro

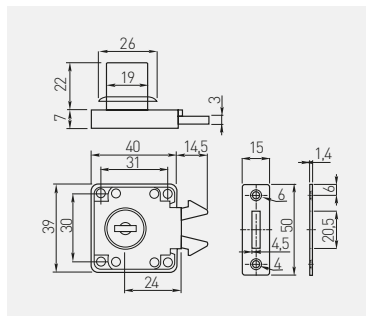

ZZ-Z0-202-01-S



Chrom / chrome / cromado



Stahl + Kunststoff + ZnAl / acier + plastique + ZnAl / acero + plástico + ZnAl

Vitrinenschloss G-328  
Serrure à crémaillère G-328  
Cerradura G-328 de barra para vitrina

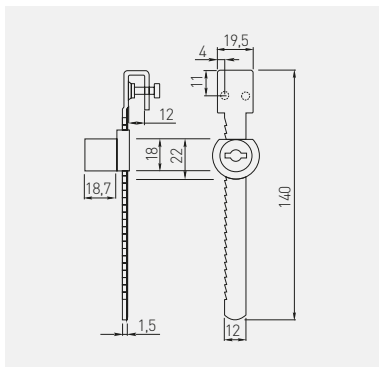

Bestimmt für 4 – 8 mm Glas  
Utilisation pour verre de 4 – 8 mm  
Compatible con vidrios de 4 – 8 mm



ZZ-G0-328-01



Chrom / chrome / cromado



ZnAl + Stahl / ZnAl + acier / ZnAl + acero

Treibstangenschloss  
Serrure à espagnolette  
Cerradura de varilla

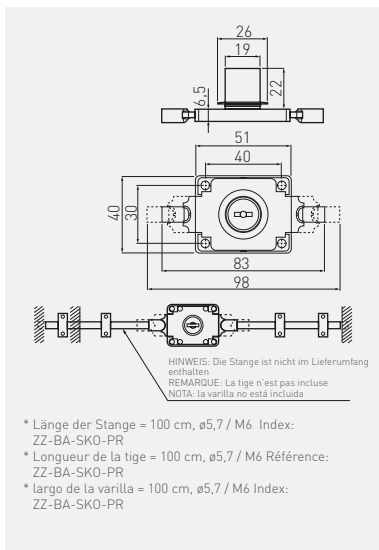

ZZ-BA-SKO-01-S

Chrom / chrome / cromado



ZZ-BA-SKO-PR

verzinkt / galvanisé / galvanizado



Stahl / acier / acero

Zentralschloss C-288  
Serrure centrale C-288  
Cerradura C-288 central

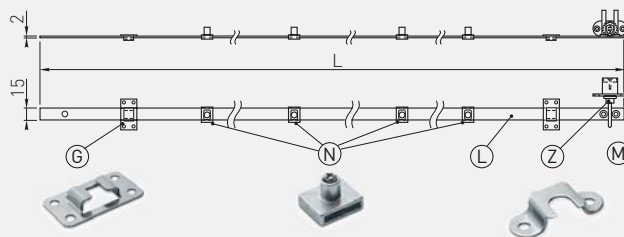
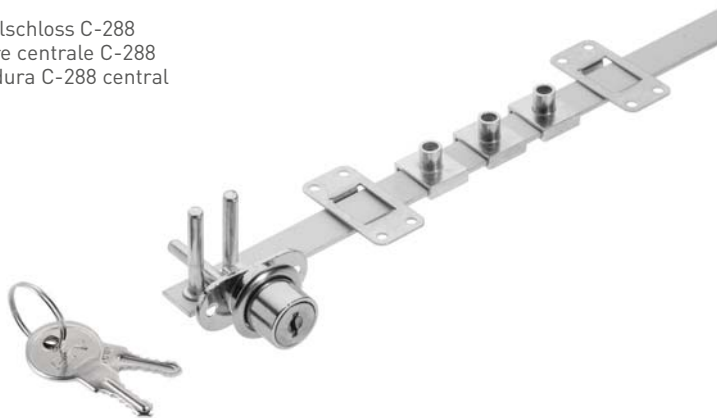

Bestandteile des Sets / Ensemble complet / Composición del conjunto

- Ⓒ Leistenbefestigung / Fixation de tringle / Fijación del rodapié
- Ⓓ Schubladenverriegelung / Serrures de tiroir / Bloqueos para cajones
- Ⓔ Schlossleiste / Tringle de verrouillage / Tiras de cierre
- Ⓕ Schloss / Serrure / Cerradura
- Ⓜ Zapfen / Gâche / Enganche

Model	C5	C6	C8	C1
L	500	600	800	1200
N	3	3	4	4
M	3	3	4	4
G	2	2	3	3

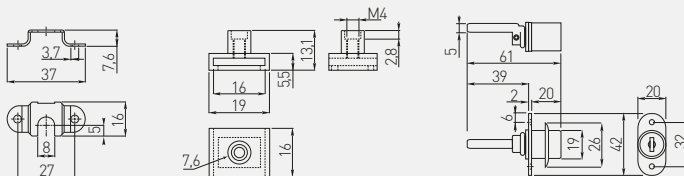

Icon	L mm	Material	Material
ZZ-C5-288-01-S	500	Chrom / chrome / cromado	ZnAl + Stahl / ZnAl + acier / ZnAl + acero
ZZ-C6-288-01-S	600		
ZZ-C8-288-01-S	800		
ZZ-C1-288-01-S	1200		
ZZ-SP-105-05	-	silberfarben / argent / plata	Stahl + Kunststoff / acier + plastique / acero + plástico
ZZ-SP-KLMASTER	-	Chrom / chrome / cromado	

Lüftungsgitter  
Grille de ventilation  
Rejilla de ventilación

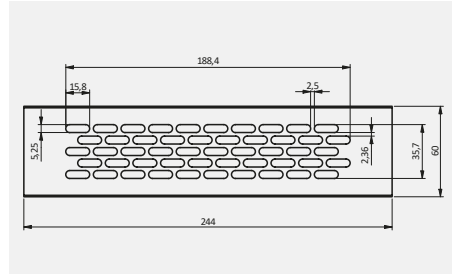



KK-W60245-M0	Luftdurchsatz – 40 cm <sup>2</sup> ouverture d'air – 40 cm <sup>2</sup> capacidad de aire – 40 cm <sup>2</sup>	Aluminium / aluminium / aluminio	Aluminium aluminium aluminio
KK-W60245-M1		weiß / blanc / blanco	
KK-W60245-M2		schwarz / noir / negro	
KK-W60245-M6		Edelstahloptik / acier brossé / acero pulido	
KK-W60245-24		anthrazit / anthracite / antracita	
KK-W60245-21		Gold / or / oro	

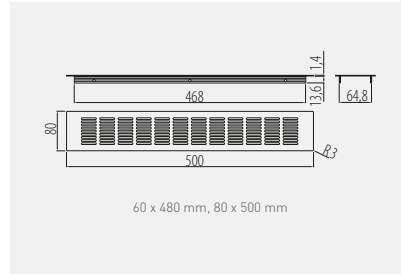

Lüftungsgitter D50-80  
Grille de ventilation D50-80  
Rejilla de ventilación D50-80



 KK-D50-80-06	 Luftdurchsatz – 108 cm <sup>2</sup> ouverture d'air – 108 cm <sup>2</sup> capacidad de aire – 108 cm <sup>2</sup>	 Edelstahloptik, acier brossé, acero pulido	 Aluminium aluminium aluminio
---	--	---	---



Lüftungsgitter D50-100  
Grille de ventilation D50-100  
Rejilla de ventilación D50-100

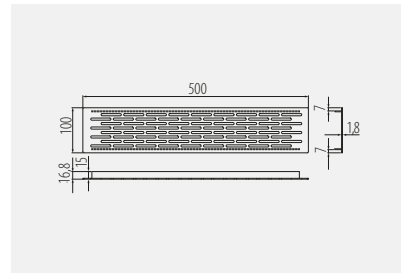

 KK-D50100-06	 Luftdurchsatz – 130 cm <sup>2</sup> ouverture d'air – 130 cm <sup>2</sup> capacidad de aire – 130 cm <sup>2</sup>	 Edelstahloptik, acier brossé, acero pulido	 Aluminium aluminium aluminio
---	--	---	---



## Lüftungsgitter W60

### Grille de ventilation W60

### Rejilla de ventilación W60

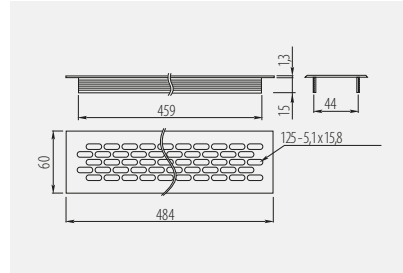

KK-W60800-M0	Luftdurchsatz – 94 cm <sup>2</sup> ouverture d'air – 94 cm <sup>2</sup> capacidad de aire – 94 cm <sup>2</sup>	grau / gris / gris	Aluminium aluminium aluminio
KK-W60800-M1		weiß / blanc / blanco	
KK-W60800-M2		schwarz / noir / negro	
KK-W60800-24		anthrazit / anthracite / antracita	
KK-W60800-06		Edelstahloptik / acier brossé / acero pulido	
KK-W60800-21		Gold / or / oro	



## Lüftungsgitter W80

### Grille de ventilation W80

### Rejilla de ventilación W80

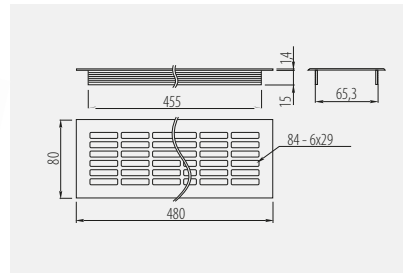

KK-W80800-D0	Luftdurchsatz – 146 cm <sup>2</sup> ouverture d'air – 146 cm <sup>2</sup> capacidad de aire – 146 cm <sup>2</sup>	grau / gris / gris	Aluminium aluminium aluminio
KK-W80800-D1		weiß / blanc / blanco	
KK-W80800-D2		schwarz / noir / negro	
KK-W80800-24		anthrazit / anthracite / antracita	
KK-W80800-06		Edelstahloptik / acier brossé / acero pulido	
KK-W80800-21		Gold / or / oro	



Lüftungsgitter W80  
Grille de ventilation W80  
Rejilla de ventilación W80

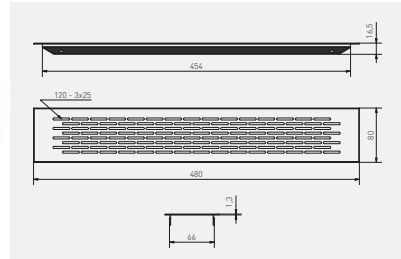

KK-W80480-05	Luftdurchsatz – 146 cm <sup>2</sup> ouverture d'air – 146 cm <sup>2</sup> capacidad de aire – 146 cm <sup>2</sup>	grau / gris / gris	Aluminium aluminium aluminio
KK-W80480-10		weiß / blanc / blanco	
KK-W80480-20M		schwarz / noir / negro	
KK-W80480-24		anthrazit / anthracite / antracita	
KK-W80480-06		Edelstahloptik / acier brossé / acero pulido	
KK-W80480-21		Gold / or / oro	



Drehgestell rund  
Plateau tournant rond  
Plataforma giratoria redonda

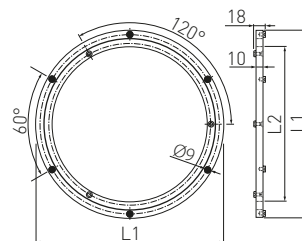





OM-OBO300-05	L1 300 mm	L2 248 mm	60	Aluminium aluminium aluminio	Aluminium aluminium aluminio
OM-OBO400-05	400	338	100		



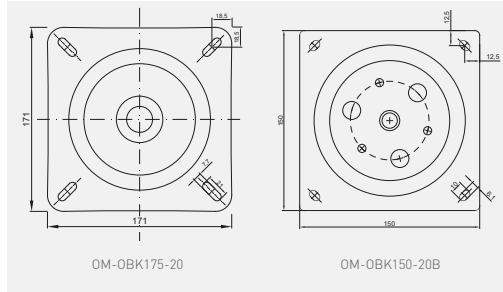

Drehgestell quadratisch  
 Plateau tournant carré  
 Plataforma giratoria cuadrada



			
OM-OBK150-20B	50	schwarz noir negro	Stahl acier acero
OM-OBK175-20*	100		



**DEKORATIVE BESCHLÄGE**  
**ACCESSOIRES DE DÉCORATION**  
**ACCESORIOS DECORATIVOS**

Möbelgriffe und -knöpfe

Poignées

Tiradore

340 – 447

Kleiderhaken

Suspensions

Perchas

448 – 455

Regalwinkel

Supports d'étagères

Soportes

456 – 463

Möbelfüße

Pieds de meubles

Patas de muebles

464 – 484

Tischbeine

Pieds de meubles

Patas de muebles

485 – 499

Möbelrollen

Roues pour meubles

Ruedas de muebles

500 – 505



Griff EXTEND  
Poignée EXTEND  
Tirador EXTEND

NEW

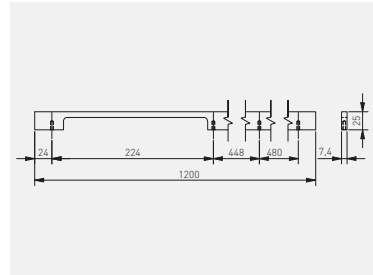

C  
mm

L  
mm



C mm	L mm	weiß, blanc, blanco	schwarz matt, noir mat, negro mate	Gold, or, oro	Aluminium, aluminium, aluminio
224/448/480	1200	UA-EXTEND-1200-10M	UA-EXTEND-1200-20M	UA-EXTEND-1200-22	



Griff HEXA LONG  
Poignée HEXA LONG  
Tirador HEXA LONG

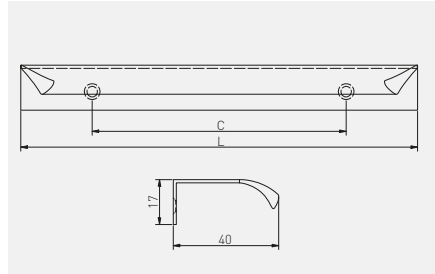

C mm	L mm			
		Aluminium, aluminium, aluminio	weiß matt, blanc mat, blanco mate	Aluminium, aluminium, aluminio
352	1200	UA-HEXA-1200-05	UA-HEXA-1200-10M	
C mm	L mm			
		schwarz matt, noir mat, negro mate	Gold, or, oro	Aluminium, aluminium, aluminio
352	1200	UA-HEXA-1200-20M	UA-HEXA-1200-22	



Griff OCTAVIO  
Poignée OCTAVIO  
Tirador OCTAVIO

NEW



C  
mm

L  
mm



C	L	Chrom, chrome, cromado	Messing, laiton, latón,	Edelstahl, acier brossé, acero pulido	Gold gebürstet, or brossé, oro cepillado	schwarz matt, noir mat, negro mate	
128	139	UZ-OCTAVIO-128-01	UZ-OCTAVIO-128-03	UZ-OCTAVIO-128-06	UZ-OCTAVIO-128-18	UZ-OCTAVIO-128-20M	ZnAl
160	171	UZ-OCTAVIO-160-01	UZ-OCTAVIO-160-03	UZ-OCTAVIO-160-06	UZ-OCTAVIO-160-18	UZ-OCTAVIO-160-20M	
192	203	UZ-OCTAVIO-192-01	UZ-OCTAVIO-192-03	UZ-OCTAVIO-192-06	UZ-OCTAVIO-192-18	UZ-OCTAVIO-192-20M	

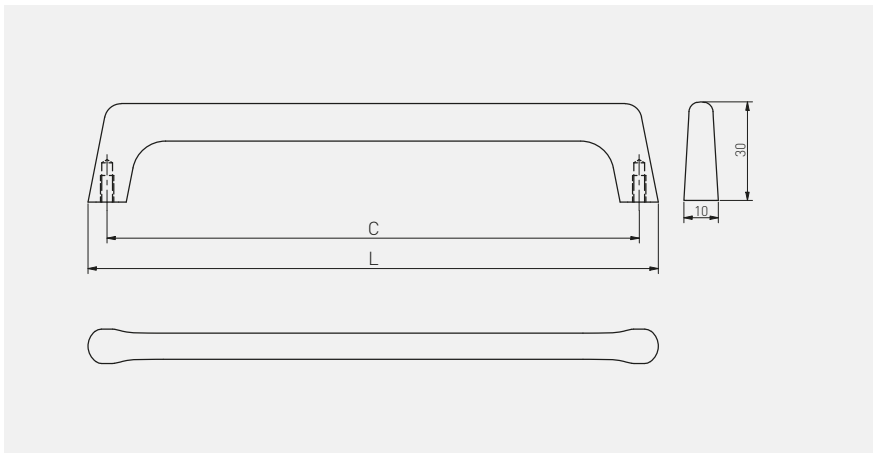



Griff CAPRI  
Poignée CAPRI  
Tirador CAPRI

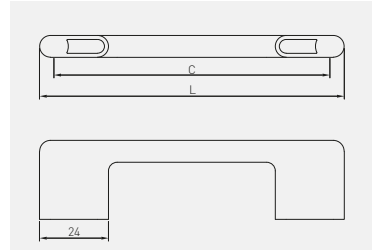

C	L	Chrom, chrome, cromado	Nickel matt satiné satinado	Aluminium, aluminium, aluminio	Edelstahl optik, acier brossé, acero pulido	schwarz matt, noir mat, negro mate	
96	106	UZ-CAPRI-96-01	UZ-CAPRI-96-02	UZ-CAPRI-96-05	UZ-CAPRI-96-06	-	
128	138	UZ-CAPRI-128-01	UZ-CAPRI-128-02	UZ-CAPRI-128-05	UZ-CAPRI-128-06	UZ-CAPRI-128-20M	ZnAl
160	170	UZ-CAPRI-160-01	UZ-CAPRI-160-02	UZ-CAPRI-160-05	UZ-CAPRI-160-06	UZ-CAPRI-160-20M	
192	202	UZ-CAPRI-192-01	UZ-CAPRI-192-02	UZ-CAPRI-192-05	UZ-CAPRI-192-06	UZ-CAPRI-192-20M	
256	266	UZ-CAPRI-256-01	UZ-CAPRI-256-02	UZ-CAPRI-256-05	UZ-CAPRI-256-06	UZ-CAPRI-256-20M	
320	330	UZ-CAPRI-320-01	UZ-CAPRI-320-02	UZ-CAPRI-320-05	UZ-CAPRI-320-06	-	





Knopf SPOT  
Bouton SPOT  
Pomo SPOT

NEW

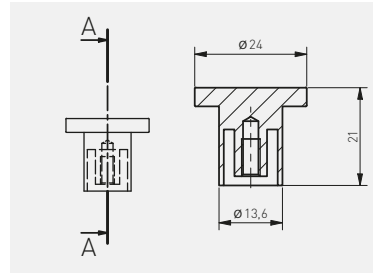

	Messing, laiton, latón,	Edelstahloptik, acier brossé, acero pulido	Gold gebürstet, or brossé, oro cepillado	schwarz matt, noir mat, negro mate	weiß, blanc, blanco	ZnAl
<b>Knopf bouton pomo</b>	GZ-SPOT-1-03	GZ-SPOT-1-06	GZ-SPOT-1-18	GZ-SPOT-1-20M	GZ-SPOT-1-10	

MODERN



Griff BAGIO  
Poignée BAGIO  
Tirador BAGIO

NEW

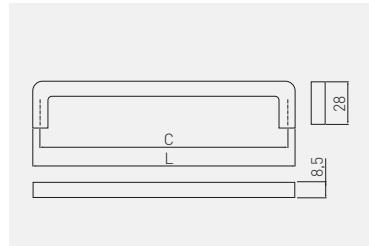

C mm	L mm					
		Chrom, chrome, cromado	Altmessing laiton ancien latón envejecido	Aluminium, aluminium, aluminio	Edelstahl optik, acier brossé, acero pulido	ZnAl
128	136	UZ-BAGIO-128-01	UZ-BAGIO-128-04	UZ-BAGIO-128-05	UZ-BAGIO-128-06	
160	168	UZ-BAGIO-160-01	UZ-BAGIO-160-04	UZ-BAGIO-160-05	UZ-BAGIO-160-06	
192	200	UZ-BAGIO-192-01	UZ-BAGIO-192-04	UZ-BAGIO-192-05	UZ-BAGIO-192-06	
320	328	UZ-BAGIO-320-01	UZ-BAGIO-320-04	UZ-BAGIO-320-05	UZ-BAGIO-320-06	

C mm	L mm						
		Altsilber argent ancien plata envejecida	gebürstetes Titan titane brossé titanio pulido	Kupfer cuivre cobre	Champagner champagne champaña	schwarz matt, noir mat, negro mate	ZnAl
128	136	UZ-BAGIO-128-07	UZ-BAGIO-128-11	UZ-BAGIO-128-15	UZ-BAGIO-128-90	UZ-BAGIO-128-20M	
160	168	UZ-BAGIO-160-07	UZ-BAGIO-160-11	UZ-BAGIO-160-15	UZ-BAGIO-160-90	UZ-BAGIO-160-20M	
192	200	UZ-BAGIO-192-07	UZ-BAGIO-192-11	UZ-BAGIO-192-15	UZ-BAGIO-192-90	UZ-BAGIO-192-20M	
320	328	UZ-BAGIO-320-07	UZ-BAGIO-320-11	UZ-BAGIO-320-15	UZ-BAGIO-320-90	UZ-BAGIO-320-20M	



Griff VITO  
Poignée VITO  
Tirador VITO

NEW

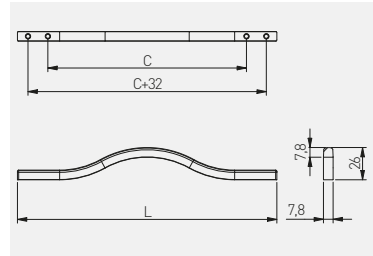

C mm	L mm				
		Chrom, chrome, cromado	Aluminium, aluminium, aluminio	Alt Silber argent ancien plata envejecida	ZnAl
160	210	UZ-VITO-160-01	UZ-VITO-160-05	UZ-VITO-160-07	
288	340	UZ-VITO-288-01	UZ-VITO-288-05	UZ-VITO-288-07	
C mm	L mm				
		schwarz, Chrom noir, chrome, negro, cromado	Gold Messing, laiton doré, latón dorado	schwarz matt, noir mat, negro mate	ZnAl
160	210	UZ-VITO-160-12	UZ-VITO-160-16	UZ-VITO-160-20M	
288	340	UZ-VITO-288-12	UZ-VITO-288-16	UZ-VITO-288-20M	



Knopf DUNE  
Bouton DUNE  
Pomo DUNE

NEW

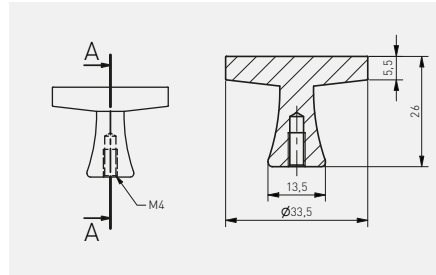

	Edelstahl optik, acier brossé, acero pulido	Gold Messing, laiton doré, latón dorado	schwarz matt, noir mat, negro mate	
<b>Knopf bouton pomo</b>	GZ-DUNE-1-06	GZ-DUNE-1-16	GZ-DUNE-1-20M	ZnAl



Knopf PIAZZA  
Bouton PIAZZA  
Pomo PIAZZA

NEW

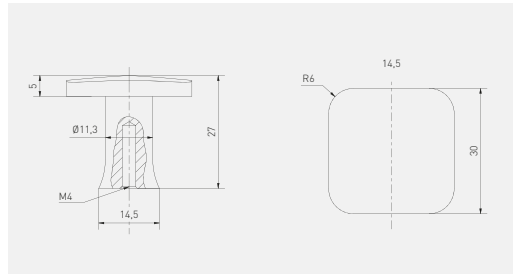

	Messing, laiton, latón,	Edelstahloptik, acier brossé, acero pulido	Gold gebürstet, or brossé, oro cepillado	schwarz matt, noir mat, negro mate	
<b>Knopf bouton pomo</b>	GZ-PIAZZA-1-03	GZ-PIAZZA-1-06	GZ-PIAZZA-1-18	GZ-PIAZZA-1-20M	ZnAl



Griff FLAVIO  
Poignée FLAVIO  
Tirador FLAVIO

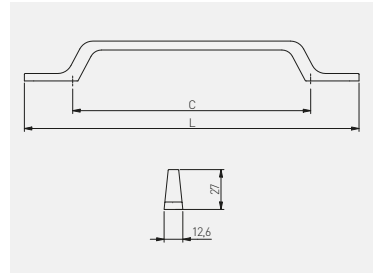

C  
mm

L  
mm



		Chrom, chrome, cromado	Messing, laiton, latón,	Edelstahloptik, acier brossé, acero pulido	Gold Messing, laiton doré, latón dorado	schwarz matt, noir mat, negro mate	
<b>96</b>	<b>161</b>	UZ-FLAVIO-96-01	UZ-FLAVIO-96-03	UZ-FLAVIO-96-06	UZ-FLAVIO-96-16	UZ-FLAVIO-96-20M	ZnAl
<b>128</b>	<b>193</b>	UZ-FLAVIO-128-01	UZ-FLAVIO-128-03	UZ-FLAVIO-128-06	UZ-FLAVIO-128-16	UZ-FLAVIO-128-20M	
<b>160</b>	<b>225</b>	UZ-FLAVIO-160-01	UZ-FLAVIO-160-03	UZ-FLAVIO-160-06	UZ-FLAVIO-160-16	UZ-FLAVIO-160-20M	
<b>192</b>	<b>200</b>	-	UZ-FLAVIO-192-03	UZ-FLAVIO-192-06	UZ-FLAVIO-192-16	UZ-FLAVIO-192-20M	
<b>320</b>	<b>328</b>	-	UZ-FLAVIO-320-03	UZ-FLAVIO-320-06	UZ-FLAVIO-320-16	UZ-FLAVIO-320-20M	



Griff MONZA  
Poignée MONZA  
Tirador MONZA

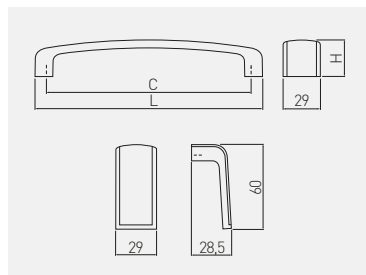

C mm	L mm	H mm				
			Edelstahloptik, Chrom, acier brossé, chrome acero pulido, cromado	weiß, Chrom blanc, chrome blanco, cromado	schwarz, Chrom noir, chrome, negro, cromado	Aluminium + ZnAl aluminium + ZnAl aluminio + ZnAl
160	178	29	UZ-MONZA160-06	UZ-MONZA160-10	UZ-MONZA160-20	
256	274	33	UZ-MONZA256-06	UZ-MONZA256-10	UZ-MONZA256-20	
384	402	34	UZ-MONZA384-06	UZ-MONZA384-10	UZ-MONZA384-20	

Griff MONA  
Poignée MONA  
Tirador MONA

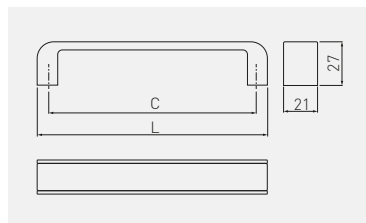



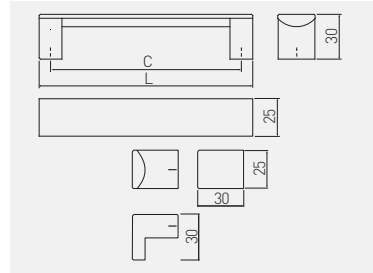

C mm	L mm			
			weiß, Chrom blanc, chrome blanco, cromado	schwarz, Chrom noir, chrome, negro, cromado
128	142		UZ-MONA-128-01-10	UZ-MONA-128-01-20
192	206		UZ-MONA-192-01-10	UZ-MONA-192-01-20
256	270		UZ-MONA-256-01-10	UZ-MONA-256-01-20

ZnAl

Griff ARES  
Poignée ARES  
Tirador ARES



C mm	L mm		
		schwarz, noir, negro	Aluminium, aluminium, aluminio
96	111	UA-ARS096-20	
128	143	UA-ARS128-20	
160	175	UA-ARS160-20	
192	207	UA-ARS192-20	
224	239	UA-ARS224-20	

C mm	L mm		
		schwarz, noir, negro	Aluminium, aluminium, aluminio
256	271	UA-ARS256-20	
320	335	UA-ARS320-20	
<b>Knopf bouton pomo</b>		UA-ARSG30-20	





Griff UZ-G2  
Poignée UZ-G2  
Tirador UZ-G2

NEW

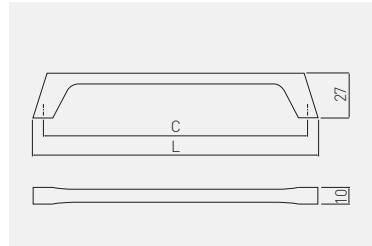

C mm	L mm				
		Chrom, chrome, cromado	Edelstahloptik, acier brossé, acero pulido	schwarz matt, noir mat, negro mate	ZnAl
160	172	UZ-G2-160-01	UZ-G2-160-06	UZ-G2-160-20M	
224	236	UZ-G2-224-01	UZ-G2-224-06	UZ-G2-224-20M	

MODERN



Griff MILANO  
Poignée MILANO  
Tirador MILANO

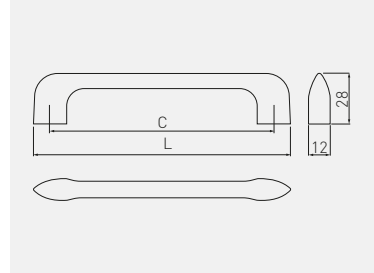

MODERN

C mm	L mm					
C	L	Chrom, chrome, cromado	Aluminium, aluminium, aluminio	Edelstahloptik, acier brossée, acero pulido	schwarz matt, noir mat, negro mate	ZnAl
128	146	UZ-MILAN-128-01	UZ-MILAN-128-05	UZ-MILAN-128-06	UZ-MILAN-128-20M	
256	274	UZ-MILAN-256-01	UZ-MILAN-256-05	UZ-MILAN-256-06	UZ-MILAN-256-20M	
Knopf bouton pomo		-	-	-	GZ-MILAN-32-20M	



Griff UZ-133  
Poignée UZ-133  
Tirador UZ-133

NEW

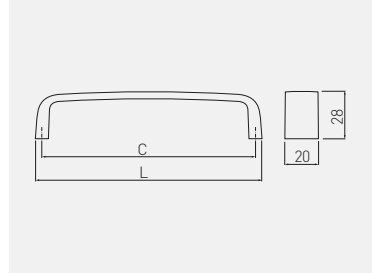

		Chrom, chrome, cromado	Nickel matt satiné satinado	Aluminium, aluminium, aluminio	Edelstahl optik, acier brossé, acero pulido	schwarz matt, noir mat, negro mate	ZnAl
128	135	UZ-133128-01	UZ-133128-02	UZ-133128-05	UZ-133128-06	UZ-133128-20M	

Griff MODENA  
Poignée MODENA  
Tirador MODENA

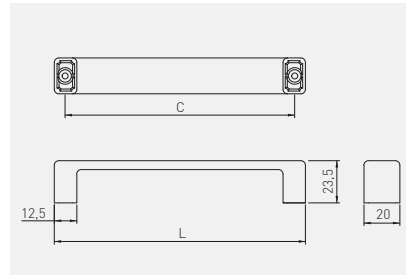

C  
mm

L  
mm



C	L	Chrom, chrome, cromado	Aluminium, aluminium, aluminio	Edelstahl optik, acier brossé, acero pulido	schwarz matt, noir mat, negro mate	ZnAl
128	140	UZ-MODEN-128-01	UZ-MODEN-128-05	UZ-MODEN-128-06	UZ-MODEN-128-20M	
160	172	UZ-MODEN-160-01	UZ-MODEN-160-05	UZ-MODEN-160-06	UZ-MODEN-160-20M	
192	204	UZ-MODEN-192-01	UZ-MODEN-192-05	UZ-MODEN-192-06	UZ-MODEN-192-20M	



Griff UZ-40  
Poignée UZ-40  
Tirador UZ-40

NEW

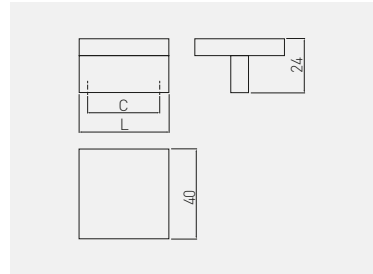

MODERN



C mm		L mm					
		Chrom, chrome, cromado	Nickel matt satiné satinado	Aluminium, aluminium, aluminio	Edelstahl optik, acier brossé, acero pulido	schwarz matt, noir mat, negro mate	ZnAl
32	40	UZ-40-032-01	UZ-40-032-02	UZ-40-032-05	UZ-40-032-06	UZ-40-032-20M	



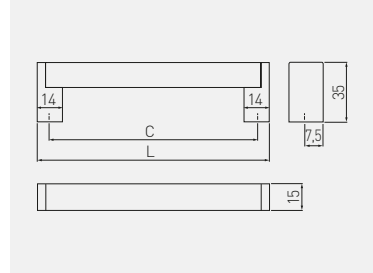

Griff UZ-334  
Poignée UZ-334  
Tirador UZ-334



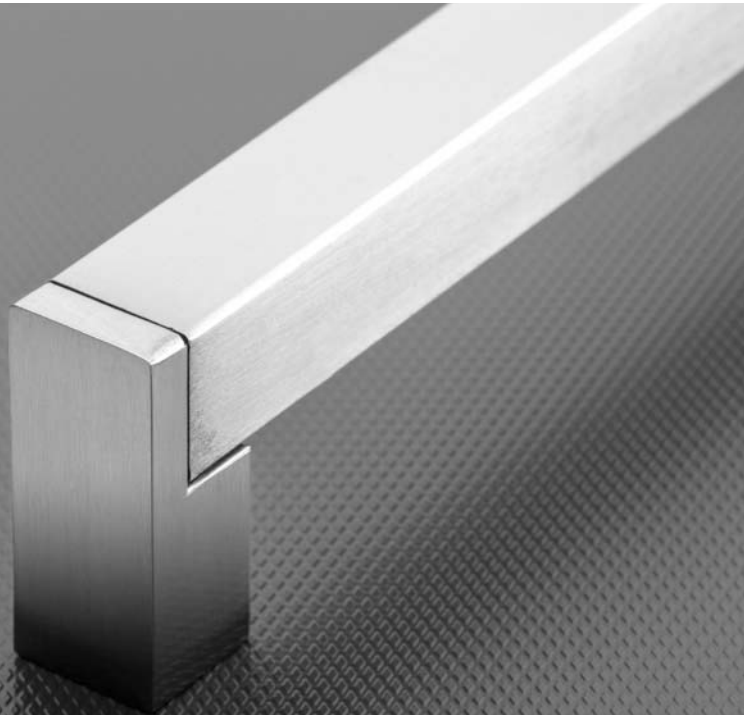

C mm	L mm		
		Edelstahloptik, acier brossé, acero pulido	ZnAl + Stahl ZnAl + acier ZnAl + acero
128	144	UZ-334128-06	
160	175	UZ-334160-06	
192	206	UZ-334192-06	
256	272	UZ-334256-06	
320	335	UZ-334320-06	



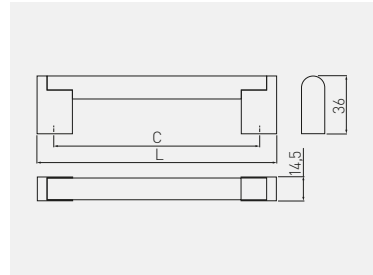



Griff UZ-336  
Poignée UZ-336  
Tirador UZ-336

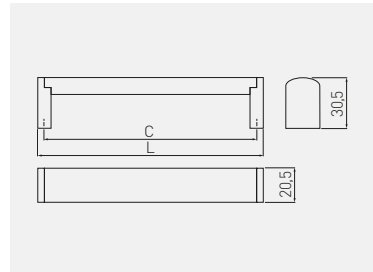

C mm	L mm			
				Edelstahloptik, acier brossé, acero pulido
128	148			UZ-336128-06
160	182			UZ-336160-06
192	213			UZ-336192-06
256	276			UZ-336256-06
320	340			UZ-336320-06
416	436			UZ-336416-06
480	500			UZ-336480-06
				ZnAl + Stahl ZnAl + acier ZnAl + acero

Griff UZ-682  
Poignée UZ-682  
Tirador UZ-682



C mm	L mm				C mm	L mm			
				Edelstahloptik, acier brossé, acero pulido					Edelstahloptik, acier brossé, acero pulido
128	136			UZ-682128-06	256	266			UZ-682256-06
160	170			UZ-682160-06	320	329			UZ-682320-06
192	209			UZ-682192-06	416	425			UZ-682416-06
224	232			UZ-682224-06	480	489			UZ-682480-06
				ZnAl + Stahl ZnAl + acier ZnAl + acero					ZnAl + Stahl ZnAl + acier ZnAl + acero

Griff UA-B311  
Poignée UA-B311  
Tirador UA-B311

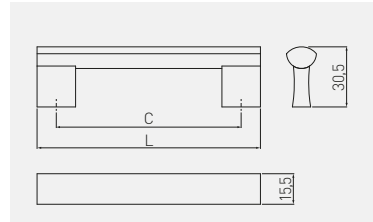

C  
mm

L  
mm



		Aluminium, aluminium, aluminio	schwarz, noir, negro	Aluminium, aluminium, aluminio
96	116	UA-B0-311096	UA-B0-311096-20M	
128	148	UA-B0-311128	UA-B0-311128-20M	
160	180	UA-B0-311160	UA-B0-311160-20M	
192	212	UA-B0-311192	UA-B0-311192-20M	
224	244	UA-B0-311224	UA-B0-311224-20M	
256	276	UA-B0-311256	UA-B0-311256-20M	
288	307	UA-B0-311288	UA-B0-311288-20M*	
320	340	UA-B0-311320	UA-B0-311320-20M	
480	500	UA-B0-311480	UA-B0-311480-20M*	

\*Produkt erhältlich auf individuelle Bestellung / Produit disponible sur demande / Producto disponible bajo demanda

Griff UA-319  
Poignée UA-319  
Tirador UA-319

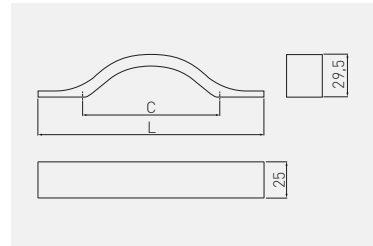

C  
mm

L  
mm







		Aluminium, aluminium, aluminio	Aluminium, aluminium, aluminio
96	158	UA-00-319096	
128	189	UA-00-319128	
160	231	UA-00-319160	

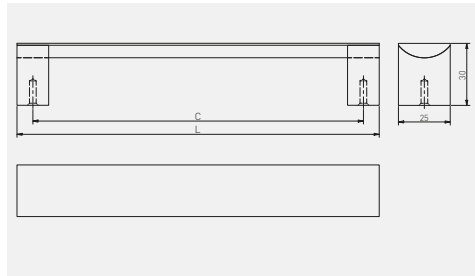





Griff UA-B337  
Poignée UA-B337  
Tirador UA-B337

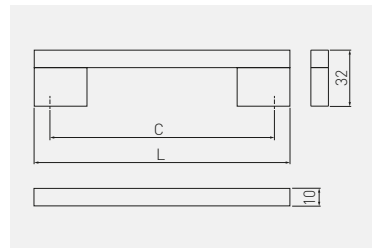

 C mm	 L mm		
		Aluminium, aluminium, aluminio	Aluminium, aluminium, aluminio
128	143	UA-B0-337128	
160	175	UA-B0-337160	
192	207	UA-B0-337192	
224	239	UA-B0-337224	
256	271	UA-B0-337256	
320	335	UA-B0-337320	





Griff UA-18  
Poignée UA-18  
Tirador UA-18

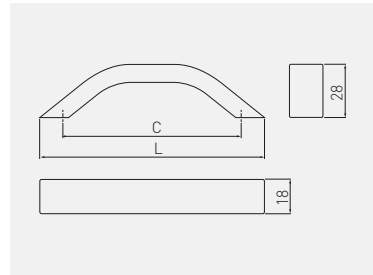

 C mm	 L mm		
		Aluminium, aluminium, aluminio	Aluminium, aluminium, aluminio
128	146	UA-18-128146	
160	178	UA-18-160178	
192	210	UA-18-192210	
224	242	UA-18-224242	
256	274	UA-18-256274	
320	338	UA-18-320338	







Griff UA-313  
Poignée UA-313  
Tirador UA-313

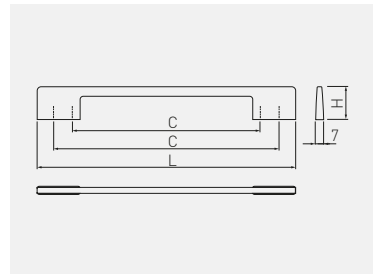

 C mm	 L mm		
		Aluminium, aluminium, aluminio	Aluminium, aluminium, aluminio
128	150	UA-00-313128	
160	182	UA-00-313160	
192	214	UA-00-313192	

Griff THIN  
Poignée THIN  
Tirador THIN



 C mm	 L mm	 H mm				
			Chrom, chrome, cromado	Aluminium, aluminium, aluminio	Edelstahloptik, acier brossé, acero pulido	ZnAl
96/128	156	24	UZ-TH096128-01	UZ-TH096128-05	UZ-TH096128-06	
160/192	220	28	UZ-TH160192-01	UZ-TH160192-05	UZ-TH160192-06	
288/320	348	28	UZ-TH288320-01	-	UZ-TH288320-06	

Griff TIVOLI  
Poignée TIVOLI  
Tirador TIVOLI

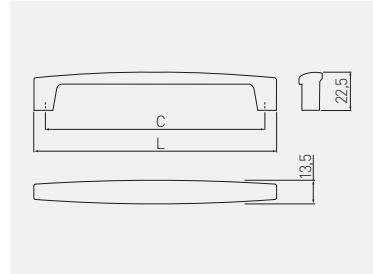

C mm	L mm				
		Chrom, chrome, cromado	schwarz Chrom noir chrome, negro cromado	Titan titan titánico	ZnAl
192	206	UZ-TIVOL-192-01	UZ-TIVOL-192-12	UZ-TIVOL-192-13	
320	334	UZ-TIVOL-320-01	UZ-TIVOL-320-12	UZ-TIVOL-320-13	

Griff ANCONA  
Poignée ANCONA  
Tirador ANCONA

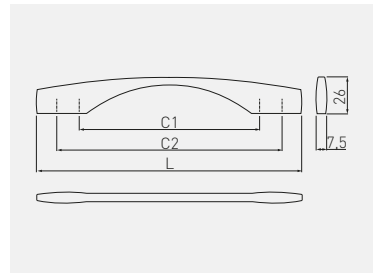

C1 mm	C2 mm	L mm			
			Chrom, chrome, cromado	Aluminium, aluminium, aluminio	Edelstahloptik, acier brossé, acero pulido
128	160	190	UZ-ANCON-128-01	UZ-ANCON-128-05	UZ-ANCON-128-06
192	224	254	UZ-ANCON-192-01	UZ-ANCON-192-05	UZ-ANCON-192-06
256	288	318	UZ-ANCON-256-01	UZ-ANCON-256-05	UZ-ANCON-256-06

Griff CLEO  
Poignée CLEO  
Tirador CLEO

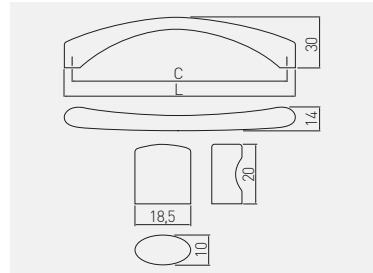

C  
mm

L  
mm



C	L	Chrom, chrome, cromado	Aluminium, aluminium, aluminio	Edelstahloptik, acier brossé, acero pulido	ZnAl
128	137	UZ-CLEO-128-01	UZ-CLEO-128-05	UZ-CLEO-128-06	ZnAl
160	169	UZ-CLEO-160-01	UZ-CLEO-160-05	UZ-CLEO-160-06	
192	201	UZ-CLEO-192-01	UZ-CLEO-192-05	UZ-CLEO-192-06	

Griff NORD  
Poignée NORD  
Tirador NORD

NEW

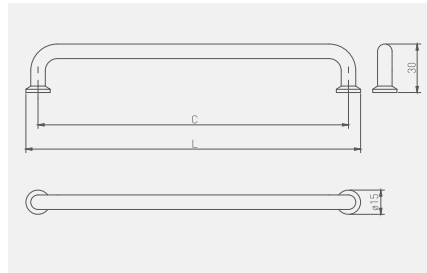

C  
mm

L  
mm



C	L	Messing, laiton, latón,	Gold gebürstet, or brossé, oro cepillado	schwarz matt, noir mat, negro mate	ZnAl
128	146	UZ-NORD-128-03	UZ-NORD-128-18	UZ-NORD-128-20M	ZnAl
160	174,5	UZ-NORD-160-03	UZ-NORD-160-18	UZ-NORD-160-20M	
192	212	UZ-NORD-192-03	UZ-NORD-192-18	UZ-NORD-192-20M	
320	334	UZ-NORD-320-03	UZ-NORD-320-18	UZ-NORD-320-20M	
Knopf bouton pomo		GZ-NORD-1-03	GZ-NORD-1-18	GZ-NORD-1-20M	



Griff VENICE  
Poignée VENICE  
Tirador VENICE

NEW

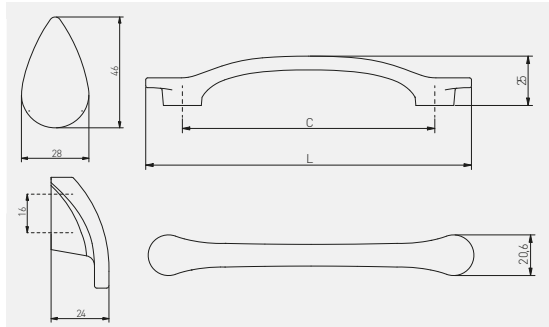

C  
mm

L  
mm



		Champagner champagne champaña	schwarz matt, noir mat, negro mate	
128	165	UZ-VENICE-128-90	UZ-VENICE-128-20M	ZnAl
Knopf bouton pomo		GZ-VENICE-1-90	GZ-VENICE-1-20M	



Griff FABRICIO  
Poignée FABRICIO  
Tirador FABRICIO

NEW

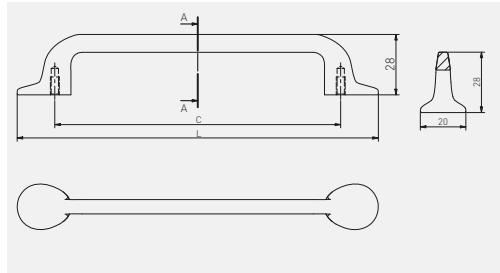

C	L				
mm	mm				
		Messing, laiton, latón,	Gold gebürstet, or brossé, oro cepillado	schwarz matt, noir mat, negro mate	ZnAl
128	161	UZ-FABRICIO-128-03	UZ-FABRICIO-128-18	UZ-FABRICIO-128-20M	
192	225	UZ-FABRICIO-192-03	UZ-FABRICIO-192-18	UZ-FABRICIO-192-20M	
320	353	UZ-FABRICIO-320-03	UZ-FABRICIO-320-18	UZ-FABRICIO-320-20M	



Knopf RING  
Bouton RING  
Pomo RING

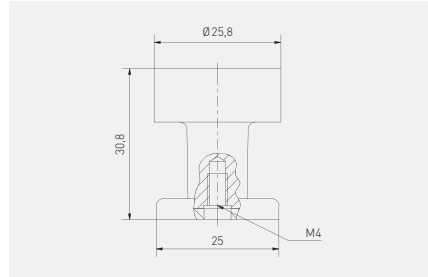

C  
mm



	Edelstahl optik, acier brossé, acero pulido	Gold gebürstet, or brossé, oro cepillado	schwarz matt, noir mat, negro mate	ZnAl
<b>Knopf bouton pomo</b>	GZ-RING-1-06	GZ-RING-1-18	GZ-RING-1-20M	





Griff FLOW  
Poignée FLOW  
Tirador FLOW

NEW

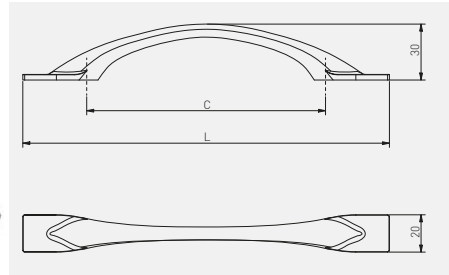

C mm	L mm				
		Edelstahloptik, acier brossé, acero pulido	Champagner champagne champaña	schwarz matt, noir mat, negro mate	ZnAl
128	200	UZ-FLOW-128-06	UZ-FLOW-128-90	UZ-FLOW-128-20M	
192	270	UZ-FLOW-192-06	UZ-FLOW-192-90	UZ-FLOW-192-20M	



Griff OTTO  
Poignée OTTO  
Tirador OTTO

NEW

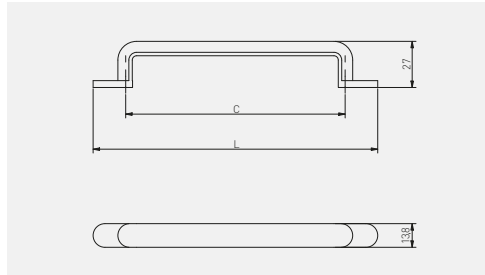

C mm	L mm				
		Edelstahl optik, acier brossé, acero pulido	Champagner champagne champana	schwarz matt, noir mat, negro mate	ZnAl
128	166	UZ-OTTO-128-06	UZ-OTTO-128-90	UZ-OTTO-128-20M	
160	198	UZ-OTTO-160-06	UZ-OTTO-160-90	UZ-OTTO-160-20M	



Griff EVER  
Poignée EVER  
Tirador EVER

NEW

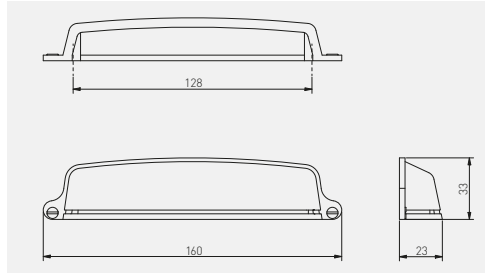

C mm	L mm			
		Champagner champagne champaña	schwarz matt, noir mat, negro mate	ZnAl
128	160	UZ-EVER-128-90	UZ-EVER-128-20M	



Griff POINT  
Bouton POINT  
Pomo POINT

NEW

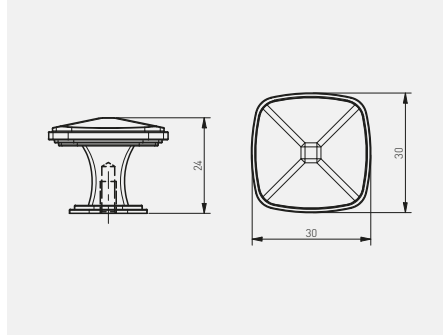

	Edelstahloptik, acier brossé, acero pulido	Gold gebürstet, or brossé, oro cepillado	schwarz matt, noir mat, negro mate	
<b>Knopf bouton pomo</b>	GZ-POINT-1-06	GZ-POINT-1-18	GZ-POINT-1-20M	ZnAl



Griff LORENA  
Bouton LORENA  
Pomo LORENA

NEW

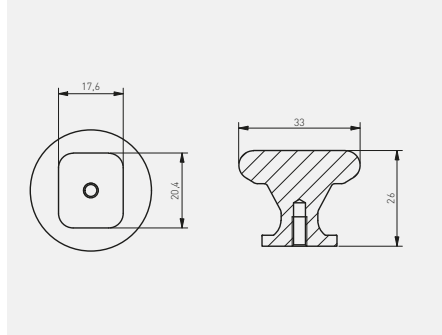

	Messing, laiton, latón,	Gold gebürstet, or brossé, oro cepillado	schwarz matt, noir mat, negro mate	gebürstet anthrazit, anthracile brossé, antracita envejecido	
<b>Knopf bouton pomo</b>	GZ-LORENA-1-03	GZ-LORENA-1-18	GZ-LORENA-1-20M	GZ-LORENA-1-21	ZnAl

CLASSIC





Griff STEP  
Poignée STEP  
Tirador STEP

NEW

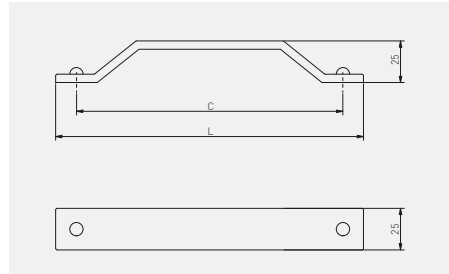

C mm	L mm		
		Altsilber argent ancien plata envejecida	schwarz matt, noir mat, negro mate
160	185	UZ-STEP-160-07	UZ-STEP-160-20M
		ZnAl	



Griff STILO  
Poignée STILO  
Tirador STILO

NEW

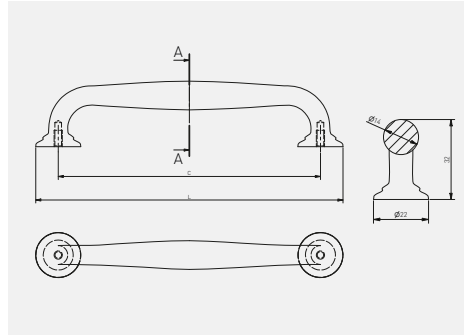

C mm	L mm			
		Gold gebürstet, or brossé, oro cepillado	schwarz matt, noir mat, negro mate	
128	147	UZ-STILO-128-18	UZ-STILO-128-20M	ZnAl
160	179	UZ-STILO-160-18	UZ-STILO-160-20M	
Knopf bouton pomo		GZ-STILO-1-18	GZ-STILO-1-20M	

CLASSIC



Griff CAMAIO  
Poignée CAMAIO  
Tirador CAMAIO

NEW

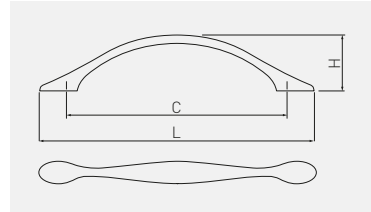

	C mm	L mm	H mm	Chrom, chrome, cromado	Nickel matt satiné satinado	Edelstahl optik, acier brossé, acero pulido	gebürstetes Altmessing, laiton antique brossé, latón envejecido pulido,
96	126	23		UZ-CAMAI-96-01	UZ-CAMAI-96-02	UZ-CAMAI-96-06	UZ-CAMAI-96-09
128	160	32,5		UZ-CAMAI-128-01	UZ-CAMAI-128-02	UZ-CAMAI-128-06	UZ-CAMAI-128-09



	C mm	L mm	H mm	weiß matt, blanc mat, blanco mate	schwarz matt, noir mat, negro mate	Champagner champagne champaña	schwarz, Chrom noir, chrome, negro, cromado	ZnAl
96	126	23		UZ-CAMAI-96-10M	UZ-CAMAI-96-20M	UZ-CAMAI-96-90	UZ-CAMAI-96-12	
128	160	32,5		UZ-CAMAI-128-10M	UZ-CAMAI-128-20M	UZ-CAMAI-128-90	UZ-CAMAI-128-12	





Knopf BERGAMO  
Bouton BERGAMO  
Pomo BERGAMO

NEW

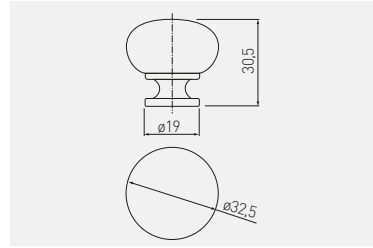

	Chrom, chrome, cromado	Nickel matt satiné satinado	Aluminium, aluminium, aluminio	Edelstahlloptik, acier brossé, acero pulido	Stahl, acier, acero,
<b>Knopf bouton pomo</b>	GS-BERGA-1-01	GS-BERGA-1-02	GS-BERGA-1-05	GS-BERGA-1-06	



	weiß, blanc, blanco	schwarz matt, noir mat, negro mate	schwarz, Chrom noir, chrome, negro, cromado	Champagner champagne champaña	Stahl, acier, acero,
<b>Knopf bouton pomo</b>	GS-BERGA-1-10	GS-BERGA-1-20M	GS-BERGA-1-12	GS-BERGA-1-90	



Knopf UDINE  
Bouton UDINE  
Pomo UDINE

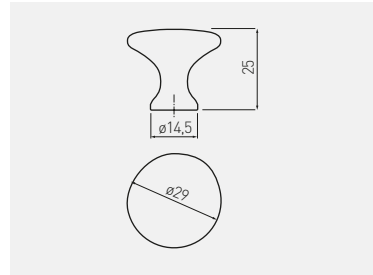

	Chrom, chrome, cromado	Nickel matt satiné satinado	Aluminium, aluminium, aluminio	Edelstahl optik, acier brossé, acero pulido	ZnAl
<b>Knopf bouton pomo</b>	GZ-UDINE-1-01	GZ-UDINE-1-02	GZ-UDINE-1-05	GZ-UDINE-1-06	



	weiß matt, blanc mat, blanco mate	schwarz Chrom noir chrome, negro cromado	schwarz matt, noir mat, negro mate	ZnAl
<b>Knopf bouton pomo</b>	GZ-UDINE-1-10M	GZ-UDINE-1-12N	GZ-UDINE-1-20M	

Griff TERNI  
Bouton TERNI  
Pomo TERNI

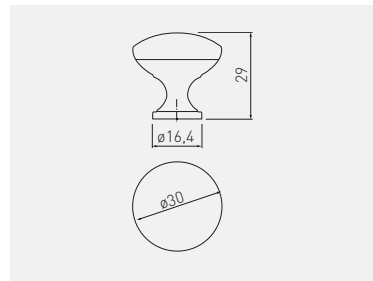

	Chrom, chrome, cromado	Nickel matt satiné satinado	Aluminium, aluminium, aluminio	Edelstahl optik, acier brossé, acero pulido	gebürstetes Altmessing, laiton antique brossé, latón envejecido pulido,
<b>Knopf bouton pomo</b>	GZ-TERNI-1-01	GZ-TERNI-1-02	GZ-TERNI-1-05	GZ-TERNI-1-06	GZ-TERNI-1-09



	weiß, blanc, blanco	schwarz Chrom noir chrome, negro cromado	Kupfer cuivre cobre	Gold Messing, laiton doré, latón dorado	schwarz matt, noir mat, negro mate	ZnAl
<b>Knopf bouton pomo</b>	GZ-TERNI-1-10	GZ-TERNI-1-12	GZ-TERNI-1-15	GZ-TERNI-1-16	GZ-TERNI-1-20M	

Griff STRUCTURE  
Poignée STRUCTURE  
Tirador STRUCTURE

NEW

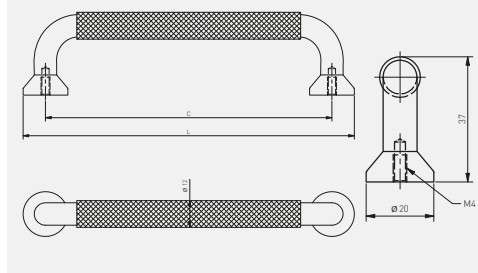

C	L		
mm	mm		
		schwarz matt, noir mat, negro mate	Aluminium, aluminium, aluminio
128	147	UA-STRUCTURE-128-20M	
192	212	UA-STRUCTURE-192-20M	
Knopf bouton pomo		GA-STRUCTURE-1-20M	

CLASSIC



Griff G0  
Poignée G0  
Tirador G0

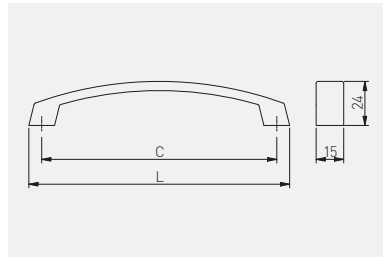

C mm	L mm				
		Chrom, chrome, cromado	Aluminium, aluminium, aluminio	Edelstahloptik, acier brossé, acero pulido	ZnAl
128	142	UZ-G0-128-01	UZ-G0-128-05	UZ-G0-128-06	
160	174	UZ-G0-160-01	UZ-G0-160-05	UZ-G0-160-06	
192	206	UZ-G0-192-01	UZ-G0-192-05	UZ-G0-192-06	
256	270	UZ-G0-256-01	UZ-G0-256-05	UZ-G0-256-06	

Griff UZ-G1  
Poignée UZ-G1  
Tirador UZ-G1

NEW

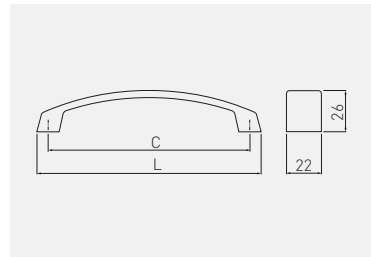

C mm	L mm					
		Chrom, chrome, cromado	Aluminium, aluminium, aluminio	Edelstahloptik, acier brossé, acero pulido	Titan titan titánico	schwarz matt, noir mat, negro mate
128	142	UZ-G1-128-01	UZ-G1-128-05	UZ-G1-128-06	UZ-G1-128-13	UZ-G1-128-20M
160	174	UZ-G1-160-01	UZ-G1-160-05	UZ-G1-160-06	UZ-G1-160-13	UZ-G1-160-20M
192	206	UZ-G1-192-01	UZ-G1-192-05	UZ-G1-192-06	UZ-G1-192-13	UZ-G1-192-20M
256	270	UZ-G1-256-01	UZ-G1-256-05	UZ-G1-256-06	UZ-G1-256-13	UZ-G1-256-20M
320	334	UZ-G1-320-01	UZ-G1-320-05	UZ-G1-320-06	UZ-G1-320-13	UZ-G1-320-20M
416	430	UZ-G1-416-01	UZ-G1-416-05	UZ-G1-416-06	-	-

Griff UA-337  
Poignée UA-337  
Tirador UA-337

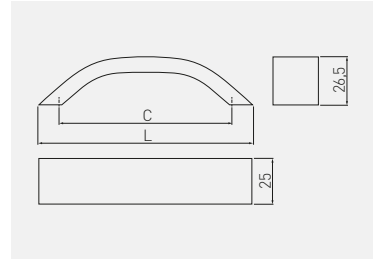

C mm	L mm			
		Aluminium, aluminium, aluminio	schwarz, noir, negro	Aluminium, aluminium, aluminio
96	116	UA-00-337096	UA-00-337096-20M	
128	146	UA-00-337128	UA-00-337128-20M	
160	180	UA-00-337160	UA-00-337160-20M	
192	212	UA-00-337192	UA-00-337192-20M	
224	244	UA-00-337224	UA-00-337224-20M	
256	275	UA-00-337256	UA-00-337256-20M	
320	340	UA-00-337320	UA-00-337320-20M	

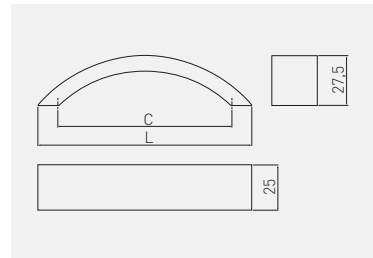

Griff UA-338  
Poignée UA-338  
Tirador UA-338



C mm	L mm			
		Aluminium, aluminium, aluminio		Aluminium, aluminium, aluminio
128	137	UA-00-338128		
160	169	UA-00-338160		

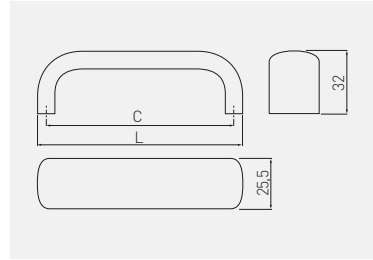

Griff UA-340  
Poignée UA-340  
Tirador UA-340



C mm	L mm		
		Aluminium, aluminium, aluminio	Aluminium, aluminium, aluminio
128	137	UA-00-340128	
160	169	UA-00-340160	
192	201	UA-00-340192	
224	233	UA-00-340224	
320	329	UA-00-340320	

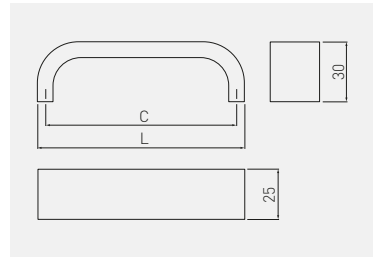

Griff UA-347  
Poignée UA-347  
Tirador UA-347

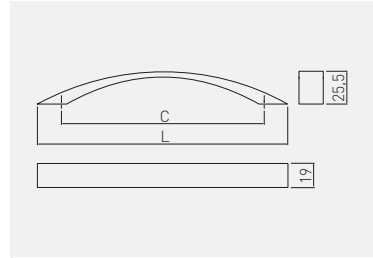

C mm	L mm		
		Aluminium, aluminium, aluminio	Aluminium, aluminium, aluminio
128	136	UA-00-347128	
160	168	UA-00-347160	
192	200	UA-00-347192	
224	232	UA-00-347224	
256	264	UA-00-347256	
320	328	UA-00-347320	

Griff CALABRIA  
Poignée CALABRIA  
Tirador CALABRIA





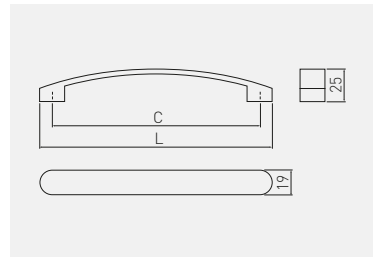

C mm	L mm			
160	195	Chrom, chrome, cromado	Edelstahlloptik, acier brossé, acero pulido	ZnAl
192	224	UZ-CALABRIA192-01	UZ-CALABRIA192-06	
224	258	UZ-CALABRIA224-01	UZ-CALABRIA224-06	

Griff GENUA  
Poignée GENUA  
Tirador GENUA



NEW



C mm	L mm				
128	148	Chrom, chrome, cromado	Nickel matt satiné satinado	Aluminium, aluminium, aluminio	ZnAl
160	180	UZ-GENUA128-01	UZ-GENUA128-02	UZ-GENUA128-05	
		UZ-GENUA160-01	UZ-GENUA160-02	UZ-GENUA160-05	UZ-GENUA160-20M

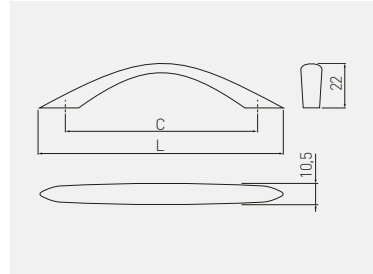

Griff UZ-01  
Poignée UZ-01  
Tirador UZ-01

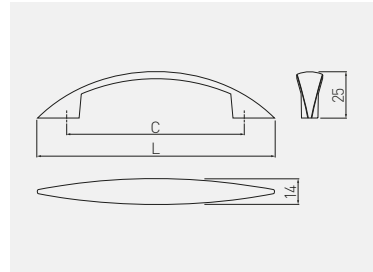

C mm	L mm				
96	121	Chrom, chrome, cromado	Nickel matt satiné satinado	Aluminium, aluminium, aluminio	ZnAl
128	158	UZ-01-096-01	UZ-01-096-02	UZ-01-096-05	
		UZ-01-128-01	UZ-01-128-02	UZ-01-128-05	

Griff UZ-05  
Poignée UZ-05  
Tirador UZ-05



C mm	L mm				
96	132	Chrom, chrome, cromado	Nickel matt satiné satinado	Aluminium, aluminium, aluminio	ZnAl
128	164	UZ-05-096-01	UZ-05-096-02	UZ-05-096-05	
		UZ-05-128-01	UZ-05-128-02	UZ-05-128-05	





Griff UZ-06  
Poignée UZ-06  
Tirador UZ-06

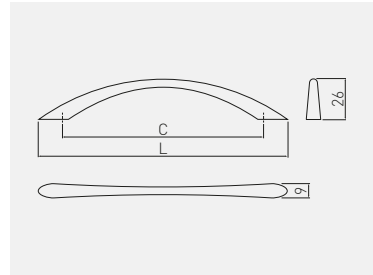

C mm	L mm				
128	164	Chrom, chrome, cromado	Nickel matt satiné satinado	Aluminium, aluminium, aluminio	ZnAl
		UZ-06-128-01	UZ-06-128-02	UZ-06-128-05	

Griff UZ-07  
Poignée UZ-07  
Tirador UZ-07

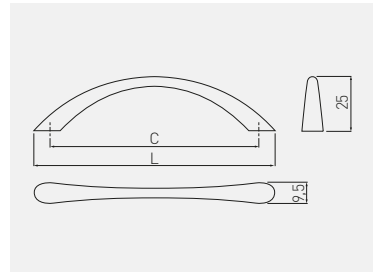

C mm	L mm				
96	111	Chrom, chrome, cromado	Nickel matt satiné satinado	Aluminium, aluminium, aluminio	ZnAl
		UZ-07-096-01	UZ-07-096-02	UZ-07-096-05	

Griff UZ-Z10  
Poignée UZ-Z10  
Tirador UZ-Z10

NEW

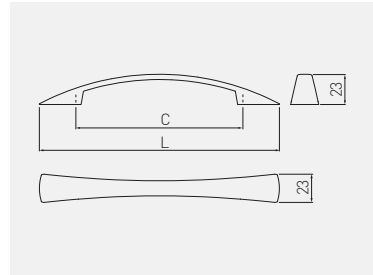

C mm	L mm					
		Chrom, chrome, cromado	Nickel matt satiné satinado	Aluminium, aluminium, aluminio	schwarz matt, noir mat, negro mate	ZnAl
96	138	UZ-Z10096-01	UZ-Z10096-02	UZ-Z10096-05	UZ-Z10096-20M	
128	184	UZ-Z10128-01	UZ-Z10128-02	UZ-Z10128-05	UZ-Z10128-20M	

Griff UZ-13  
Poignée UZ-13  
Tirador UZ-13

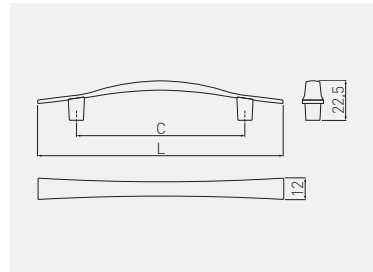

C mm	L mm					
		Chrom, chrome, cromado	Nickel matt satiné satinado	Aluminium, aluminium, aluminio		ZnAl
96	140	UZ-13-096-01	UZ-13-096-02	UZ-13-096-05		

Griff GZ-1155  
 Bouton GZ-1155  
 Pomo GZ-1155

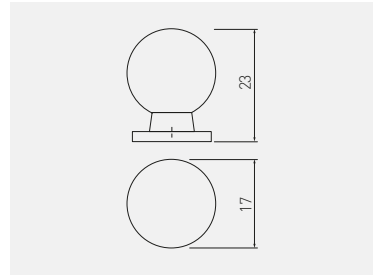

	Chrom, chrome, cromado	ZnAl
<b>Knopf bouton pomo</b>	GZ-WP1155-01	

Griff GZ-ZH  
 Bouton GZ-ZH  
 Pomo GZ-ZH

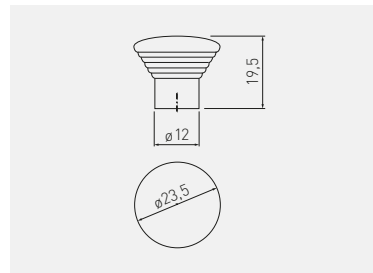

	Aluminium, aluminium, aluminio	ZnAl
<b>Knopf bouton pomo</b>	GZ-ZH-011-05A	



Griff RELING RS  
Poignée RELING RS  
Tirador RELING RS

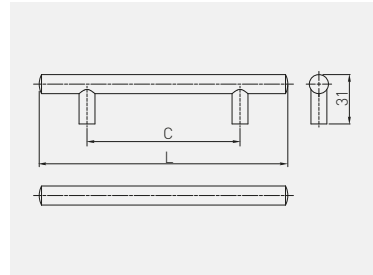

C mm	L mm	Chrom, chrome, cromado	Nickel matt satiné satinado	Aluminium, aluminium, aluminio	Edelstahl optik, acier brossé, acero pulido	Altkupfer, cuivre ancien, cobre envejecido	
96	156	RS-156096-01	RS-156096-02	RS-156096-05	RS-156096-06	RS-156096-14	Stahl, acier, acero,
128	188	RS-188128-01	RS-188128-02	RS-188128-05	RS-188128-06	RS-188128-14	
160	220	RS-220160-01	RS-220160-02	RS-220160-05	RS-220160-06	RS-220160-14	
192	272	RS-272192-01	RS-272192-02	RS-272192-05	RS-272192-06	RS-272192-14	
224	304	RS-304224-01	RS-304224-02	RS-304224-05	RS-304224-06	RS-304224-14	
256	336	RS-336256-01	RS-336256-02	RS-336256-05	RS-336256-06	RS-336256-14	
288	368	RS-368288-01	RS-368288-02	RS-368288-05	RS-368288-06	RS-368288-14*	
320	400	RS-400320-01	RS-400320-02	RS-400320-05	RS-400320-06	RS-400320-14	

C mm	L mm	Edelstahl optik, acier brossé, acero pulido	schwarz matt, noir mat, negro mate	
96	156	-	ID-RS-E-15696-20M*	Stahl, acier, acero,
128	188	-	ID-RS-E-188128-20M*	
160	220	ID-RS-E-220160-06*	ID-RS-E-220160-20M*	
192	272	ID-RS-E-272192-06*	ID-RS-E-272192-20M*	
224	304	ID-RS-E-304224-06*	ID-RS-E-304224-20M*	
256	336	ID-RS-E-336256-06*	ID-RS-E-336256-20M*	
288	368	ID-RS-E-368288-06*	ID-RS-E-368288-20M*	
320	400	ID-RS-E-400320-06*	ID-RS-E-400320-20M*	

Auf Wunsch folgende Bohrlochabstände erhältlich:  
352, 384, 416, 480, 512, 544, 576, 608, 640, 672, 704, 736, 768,  
800 (mm).

Disponible sur demande et également pour les espacements:  
352, 384, 416, 480, 512, 544, 576, 608, 640, 672, 704, 736, 768,  
800 (mm).

Los espaciadores también están disponibles para pedidos  
individuales: 352, 384, 416, 480, 512, 544, 576, 608, 640, 672,  
704, 736, 768, 800 (mm).

Altkupfer,  
cuivre ancien,  
cobre envejecido







\*Produkt erhältlich auf individuelle Bestellung / Produit disponible sur demande / Producto disponible bajo demanda

Es besteht eine Möglichkeit, zusätzliche Größen und Farben individuell zu bestellen. / Tailles et couleurs supplémentaires peuvent être achetées sur une commande individuelle. / Opción de comprar otras distancias y acabados bajo pedido individual

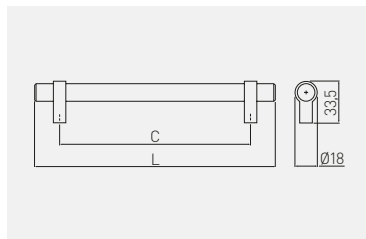

Griff TRIEST  
Poignée TRIEST  
Tirador TRIEST





 C mm	 L mm		
		Edelstahlloptik, acier brossé, acero pulido	
96	136	RS-TRIES-96-06	ZnAl + Stahl ZnAl + acier ZnAl + acero
128	168	RS-TRIES-128-06	
160	200	RS-TRIES-160-06	
192	232	RS-TRIES-192-06	
256	296	RS-TRIES-256-06	
320	360	RS-TRIES-320-06	



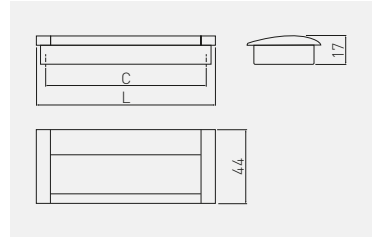

Griff UA-326  
Poignée UA-326  
Tirador UA-326



C mm	L mm				
		Aluminium, Chrom aluminium, chrome aluminio, cromado	Aluminium, aluminium, aluminio	schwarz, noir, negro	Aluminium, aluminium, aluminio
96	108	UA-01-326096-V1	UA-00-326096-05	UA-00-326096-20M	
128	140	UA-01-326128-V1	UA-00-326128-05	UA-00-326128-20M	
160	172	UA-01-326160	UA-00-326160	UA-00-326160-20M	



Griff UZ-E6  
Poignée UZ-E6  
Tirador UZ-E6

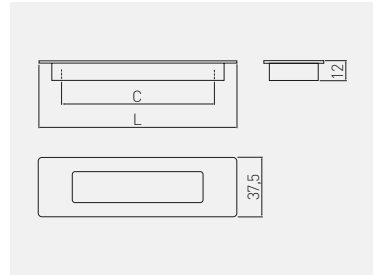



C mm	L mm				
96	124	Chrom, chrome, cromado	Aluminium, aluminium, aluminio	Edelstahlloptik, acier brossé, acero pulido	ZnAl
128	155	UZ-E6-096-01	UZ-E6-096-05	UZ-E6-096-06	
160	186	UZ-E6-128-01	UZ-E6-128-05	UZ-E6-128-06	
		UZ-E6-160-01	UZ-E6-160-05	UZ-E6-160-06	

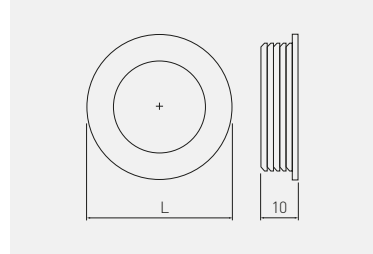

Griff B224  
Poignée B224  
Tirador B224



 L mm						
40,5	Chrom, chrome, cromado	Nickel matt satiné satinado	Aluminium, aluminium, aluminio	weiß, blanc, blanco	schwarz, noir, negro	ZnAl
	UZ-00B224-01	UZ-00B224-02	UZ-00B224-05	UZ-00B224-10	UZ-00B224-20	



Griff B226  
Poignée B226  
Tirador B226

RECESSED

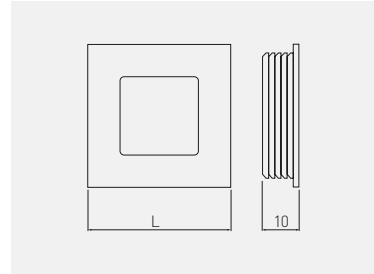

	Chrom, chrome, cromado	Nickel matt satiné satinado	Aluminium, aluminium, aluminio	weiß, blanc, blanco	schwarz, noir, negro	ZnAl
40	UZ-00B226-01	UZ-00B226-02	UZ-00B226-05	UZ-00B226-10	UZ-00B226-20	

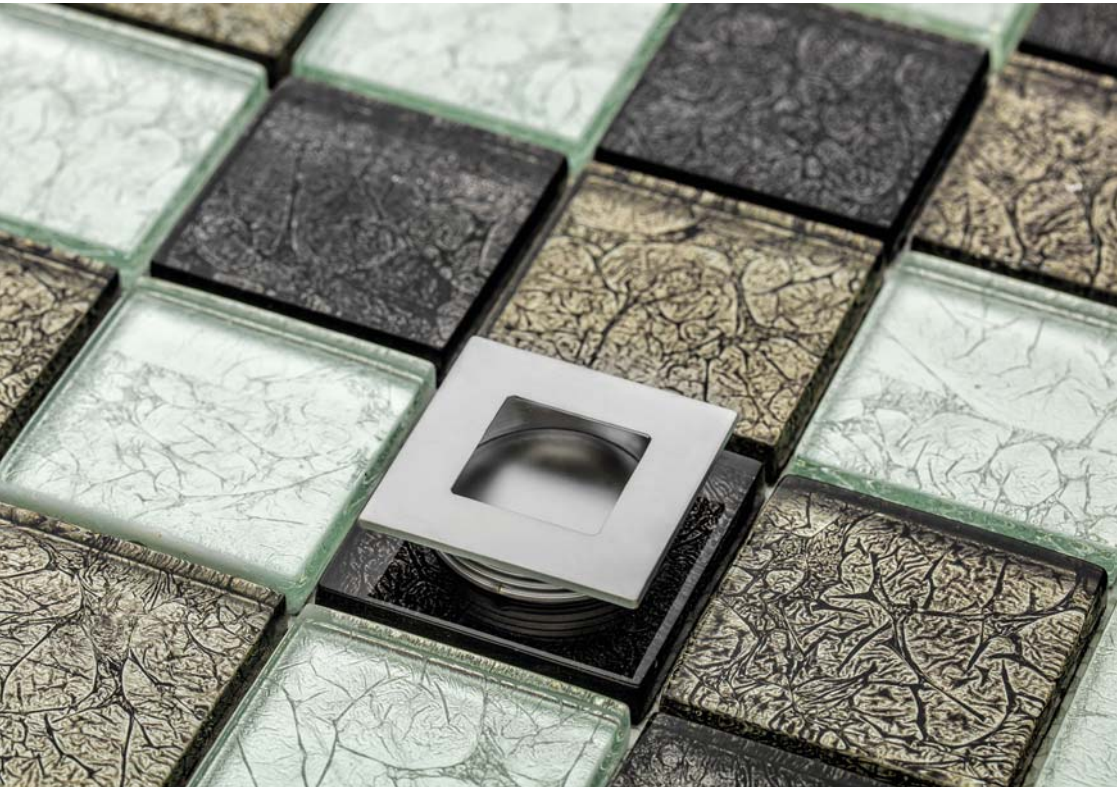



Griff LIND  
Poignée LIND  
Tirador LIND

NEW

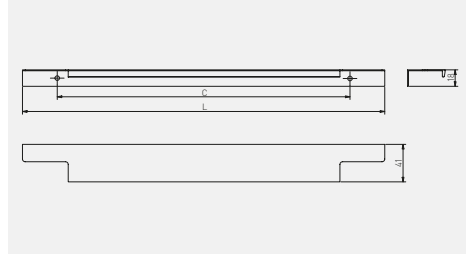

EDGE MOUNTED

C  
mm

L  
mm



		Chrom, chrome, cromado	Aluminium, aluminium, aluminio	Gold gebürstet, or brossé, oro cepillado	schwarz matt, noir mat, negro mate	
128	150	UA-LIND-150-128-01	UA-LIND-150-128-05	UA-LIND-150-128-18	UA-LIND-150-128-20M	Aluminium, aluminium, aluminio
256	296	UA-LIND-256-296-01	UA-LIND-256-296-05	UA-LIND-256-296-18	UA-LIND-256-296-20M	
320	396	UA-LIND-320-396-01	UA-LIND-320-396-05	UA-LIND-320-396-18	UA-LIND-320-396-20M	
2 x 224*	496	UA-LIND-224-496-01	UA-LIND-224-496-05	UA-LIND-224-496-18	UA-LIND-224-496-20M	
2 x 256*	596	UA-LIND-256-596-01	UA-LIND-256-596-05	UA-LIND-256-596-18	UA-LIND-256-596-20M	
2 x 352*	796	UA-LIND-352-796-01	UA-LIND-352-796-05	UA-LIND-352-796-18	UA-LIND-352-796-20M	





\*Befestigung mit 3 Schrauben / Fixation à 3 vis / Fijación de 3 tornillos



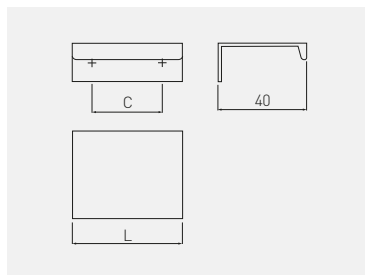



Griff HEXI  
Poignée HEXI  
Tirador HEXI

NEW



 C mm	 L mm					
		Chrom, chrome, cromado	Aluminium, aluminium, aluminio	weiß matt, blanc mat, blanco mate	schwarz matt, noir mat, negro mate	Aluminium, aluminium, aluminio
32	50	UA-HEXI-01	UA-HEXI-05	UA-HEXI-10M	UA-HEXI-20M	
96	150	UA-HEXI96-01	UA-HEXI96-05	UA-HEXI96-10M	UA-HEXI96-20M	
128	150	UA-HEXI-128-01	UA-HEXI-128-05	UA-HEXI-128-10M	UA-HEXI-128-20M	
160	190	UA-HEXI-160-01	UA-HEXI-160-05	UA-HEXI-160-10M	UA-HEXI-160-20M	
192	225	UA-HEXI192-01	UA-HEXI192-05	UA-HEXI192-10M	UA-HEXI192-20M	
256	290	UA-HEXI-256-01	UA-HEXI-256-05	UA-HEXI-256-10M	UA-HEXI-256-20M	
320	360	UA-HEXI-320-01	UA-HEXI-320-05	UA-HEXI-320-10M	UA-HEXI-320-20M	
zum Zuschneiden pour la découpe para cortar	3500	-	UA-HEXI-3500-05	-	UA-HEXI-3500-20M	





 C mm	 L mm			
		anthrazit, anthracite, antracita	Gold gebürstet, or brossé, oro cepillado	Aluminium, aluminium, aluminio
32	50	UA-HEXI-60	UA-HEXI-18	
96	150	UA-HEXI96-60	UA-HEXI96-18	
160	190	UA-HEXI-160-60	UA-HEXI-160-18	
192	225	UA-HEXI192-60	UA-HEXI192-18	
256	290	UA-HEXI-290-60	UA-HEXI-290-18	
320	360	UA-HEXI-360-60	UA-HEXI-360-18	



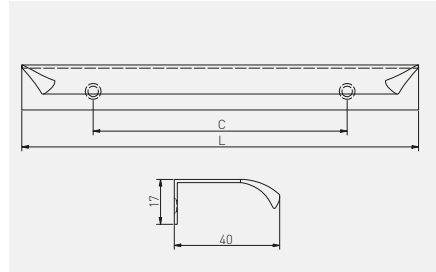



Griff HEXA  
Poignée HEXA  
Tirador HEXA

NEW



 C mm	 L mm				
		Chrom, chrome, cromado	Aluminium, aluminium, aluminio	weiß matt, blanco mat, blanco mate	 Aluminium, aluminium, aluminio
32	50	UA-HEXA-32-01	UA-HEXA-32-05	UA-HEXA-32-10M	
96	150	UA-HEXA-96-01	UA-HEXA-96-05	UA-HEXA-96-10M	
160	193	UA-HEXA-160-01	UA-HEXA-160-05	UA-HEXA-160-10M	
192	225	UA-HEXA-192-01	UA-HEXA-192-05	UA-HEXA-192-10M	
256	266	UA-HEXA-256-01	UA-HEXA-256-05	UA-HEXA-256-10M	
320	353	UA-HEXA-320-01	UA-HEXA-320-05	UA-HEXA-320-10M	

 C mm	 L mm				
		Gold gebürstet, or brossé, oro cepillado	schwarz matt, noir mat, negro mate	Gold, or, oro	 Aluminium, aluminium, aluminio
32	50	UA-HEXA-32-18	UA-HEXA-32-20M	UA-HEXA-32-22	
96	150	UA-HEXA-96-18	UA-HEXA-96-20M	UA-HEXA-96-22	
160	193	-	UA-HEXA-160-20M	UA-HEXA-160-22	
192	225	UA-HEXA-192-18	UA-HEXA-192-20M	UA-HEXA-192-22	
256	266	-	UA-HEXA-256-20M	UA-HEXA-256-22	
320	353	-	UA-HEXA-320-20M	UA-HEXA-320-22	





Griff PICADO  
Poignée PICADO  
Tirador PICADO

NEW

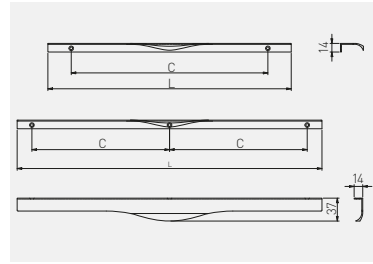

C  
mm

L  
mm



C	L	Chrom, chrome, cromado	Aluminium, aluminium, aluminio	Aluminium, aluminium, aluminio
256	296	UA-PICADO-256-296-01	UA-PICADO-256-296-05	
320	396	UA-PICADO-320-396-01	UA-PICADO-320-396-05	
2 x 224*	496	UA-PICADO-224-496-01	UA-PICADO-224-496-05	
2 x 256*	596	UA-PICADO-256-596-01	UA-PICADO-256-596-05	
2 x 352*	796	UA-PICADO-352-796-01	UA-PICADO-352-796-05	

C  
mm

L  
mm



C	L	Gold gebürstet, or brossé, oro cepillado	schwarz matt, noir mat, negro mate	Aluminium, aluminium, aluminio
256	296	UA-PICADO-256-296-18	UA-PICADO-256-296-20M	
320	396	UA-PICADO-320-396-18	UA-PICADO-320-396-20M	
2 x 224*	496	UA-PICADO-224-496-18	UA-PICADO-224-496-20M	
2 x 256*	596	UA-PICADO-256-596-18	UA-PICADO-256-596-20M	
2 x 352*	796	UA-PICADO-352-796-18	UA-PICADO-352-796-20M	

\*Befestigung mit 3 Schrauben / Fixation à 3 vis / Fijación de 3 tornillos



Griff FIORD  
Poignée FIORD  
Tirador FIORD

NEW

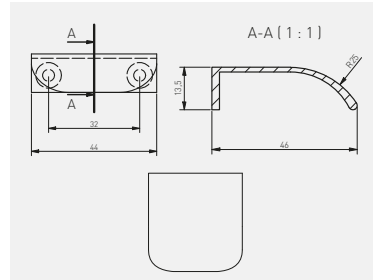

	Messing, laiton, latón,	Aluminium, aluminium, aluminio	Edelstahloptik, acier brossé, acero pulido	Gold Messing, laiton doré, latón dorado	
<b>Knopf bouton pomo</b>	UZ-FIORD-32-03	UZ-FIORD-32-05	UZ-FIORD-32-06	UZ-FIORD-32-16	ZnAl



	Gold gebürstet, or brossé, oro cepillado	Edelstahloptik, acier brossé, acero pulido	weiß, blanc, blanco	schwarz matt, noir mat, negro mate	
<b>Knopf bouton pomo</b>	UZ-FIORD-32-18	UZ-FIORD-32-06	UZ-FIORD-32-10	UZ-FIORD-32-20M	ZnAl

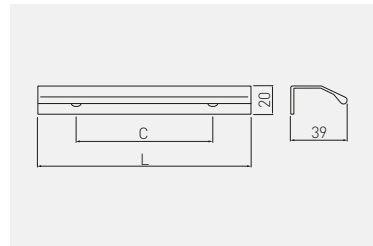

Griff TREX  
Poignée TREX  
Tirador TREX

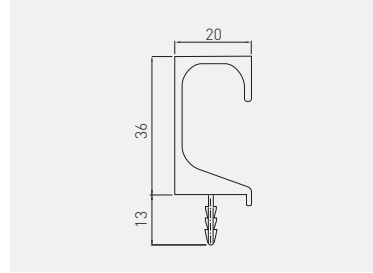

<b>C</b> mm	<b>L</b> mm	Aluminium, aluminium, aluminio	schwarz matt, noir mat, negro mate	Aluminium, aluminium, aluminio
32	50	UA-TREX-32-50-05	UA-TREX-32-50-20M	
96	150	UA-TREX-96-150-05	UA-TREX-96-150-20M	
224	250	UA-TREX-224-250-05	UA-TREX-224-250-20M	
320	350	UA-TREX-320-350-05	UA-TREX-320-350-20M	
zum Zuschneiden pour la découpe para cortar	3500	UA-TREX-3500-05	UA-TREX-3500-20M	

Griff PROFIL C  
Poignée PROFIL C  
Tirador PROFIL C



 C mm	 L mm		
		Aluminium, aluminium, aluminio	Edelstahloptik, acier brossé, acero pulido
			schwarz matt, noir mat, negro mate
zum Zuschneiden pour la découpe para cortar	3500	PA-0242-35-50	PA-0242-35-50-20M
			Aluminium, aluminium, aluminio



Griff PROFIL L  
Poignée PROFIL L  
Tirador PROFIL L

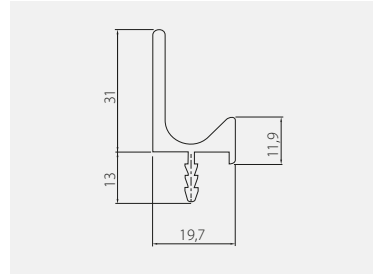

C mm	L mm				
zum Zuschneiden pour la découpe para cortar	3500	Aluminium, aluminium, aluminio	Edelstahloptik, acier brossé, acero pulido	schwarz matt, noir mat, negro mate	Aluminium, aluminium, aluminio
		PA-0243-35-50	PA-0243-35-50-06	PA-0243-35-50-20M	



## Griffloses System VELLO

### Système d'ouverture sans poignée VELLO

### Sistema sin tirador VELLO

NEW

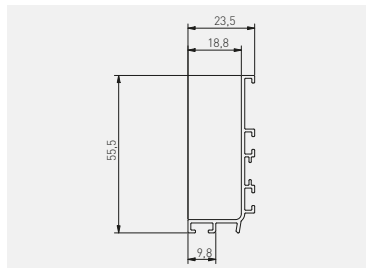

	C mm	L mm			
zum Zuschneiden pour la découpe para cortar	3000	PA-VELLO-L3M-05	Edelstahl optik, acier brossé, acero pulido	weiß, blanc, blanco	Aluminium, aluminium, aluminio
	4100	PA-VELLO-L4M-05	PA-VELLO-L3M-06	PA-VELLO-L3M-10	
		PA-VELLO-L4M-06	PA-VELLO-L4M-06	PA-VELLO-L4M-10	

	C mm	L mm			
zum Zuschneiden pour la découpe para cortar	3000	PA-VELLO-L3M-20M	schwarz matt, noir mat, negro mate	Gold, or, oro	Aluminium, aluminium, aluminio
	4100	PA-VELLO-L4M-20M	PA-VELLO-L3M-20M	–	
		PA-VELLO-L4M-21	PA-VELLO-L4M-21		

Zubehör / Accessoires / Accesorios



Abdeckungen / Capots de rail / Difusores



PA-ZASVELLO-LNL-20M

PA-ZASVELLO-LNP-20M

PA-ZASVELLO-LPL-20M

PA-ZASVELLO-LPP-20M

PA-OSMLGLAXMIC3M-00N

Aluminium, aluminium, aluminio	Edelstahl optik, acier brossé, acero pulido	weiß, blanc, blanco	Kunststoff, plastique, plástico	
PA-ZASVELLO-LNL-05	PA-ZASVELLO-LNL-06	PA-ZASVELLO-LNL-10		
PA-ZASVELLO-LNP-05	PA-ZASVELLO-LNP-06	PA-ZASVELLO-LNP-10		
PA-ZASVELLO-LPL-05	PA-ZASVELLO-LPL-06	PA-ZASVELLO-LPL-10		
PA-ZASVELLO-LPP-05	PA-ZASVELLO-LPP-06	PA-ZASVELLO-LPP-10		

schwarz matt, noir mat, negro mate	Gold, or, oro	Kunststoff, plastique, plástico	
PA-ZASVELLO-LNL-20M	PA-ZASVELLO-LNL-21		
PA-ZASVELLO-LNP-20M	PA-ZASVELLO-LNP-21		
PA-ZASVELLO-LPL-20M	PA-ZASVELLO-LPL-21		
PA-ZASVELLO-LPP-20M	PA-ZASVELLO-LPP-21		



PA-MOUNT-GL-00

Möglichkeit des Einsatzes der LED-Beleuchtung. Empfohlen wird die Abdeckung PA-OSMLGLAXMIC3M-00N.  
Possibilité d'utiliser un éclairage LED. Recommandé PA-OSMLGLAXMIC3M-00N cover.  
Posibilidad de instalar iluminación LED. Difusor recomendado PA-OSMLGLAXMIC3M-00N





## Griffloses System VELLO

### Système d'ouverture sans poignée VELLO

### Sistema sin tirador VELLO

NEW

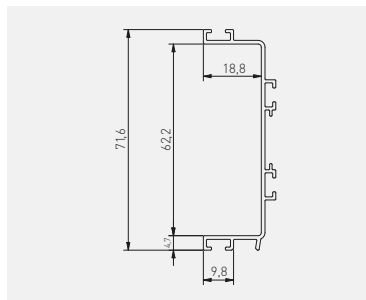

	C mm	L mm			
zum Zuschneiden pour la découpe para cortar	3000		Aluminium, aluminium, aluminio	Edelstahloptik, acier brossé, acero pulido	weiß, blanc, blanco
	4100				Aluminium, aluminium, aluminio

	C mm	L mm			
zum Zuschneiden pour la découpe para cortar	3000		schwarz matt, noir mat, negro mate	Gold, or, oro	Aluminium, aluminium, aluminio
	4100			-	

## Zubehör / Accessoires / Accesorios



## Abdeckungen / Capots de rail / Difusores



Aluminium, aluminium, aluminio	Edelstahloptik, acier brossé, acero pulido	weiß, blanc, blanco	Kunststoff, plastique, plástico
PA-ZASVELLO-CN-05	PA-ZASVELLO-CN-06	PA-ZASVELLO-CN-10	
PA-ZASVELLO-CP-05	PA-ZASVELLO-CP-06	PA-ZASVELO-CP-10	

schwarz matt, noir mat, negro mate	Gold, or, oro	Kunststoff, plastique, plástico	
PA-ZASVELLO-CN-20M	PA-ZASVELLO-CN-21		
PA-ZASVELO-CP-20M	PA-ZASVELLO-CP-21		

Möglichkeit des Einsatzes der LED-Beleuchtung. Empfohlen wird die Abdeckung PA-OSMLGLAXMIC3M-00N.

Possibilité d'utiliser un éclairage LED. Recommandé PA-OSMLGLAXMIC3M-00N cover.

Posibilidad de instalar iluminación LED. Difusor recomendado PA-OSMLGLAXMIC3M-00N









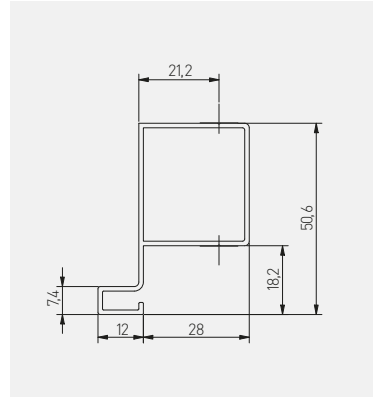



Griffloses System VELLO  
 Système d'ouverture sans poignée VELLO  
 Sistema sin tirador VELLO

NEW



	 C mm	 L mm				
zum Zuschneiden pour la découpe para cortar	3000		Aluminium, aluminium, aluminio	Edelstahl optik, acier brossé, acero pulido	weiß, blanc, blanco	Aluminium, aluminium, aluminio
			PA-VELLO-TJ3M-05	PA-VELLO-TJ3M-06	PA-VELLO-TJ3M-10	

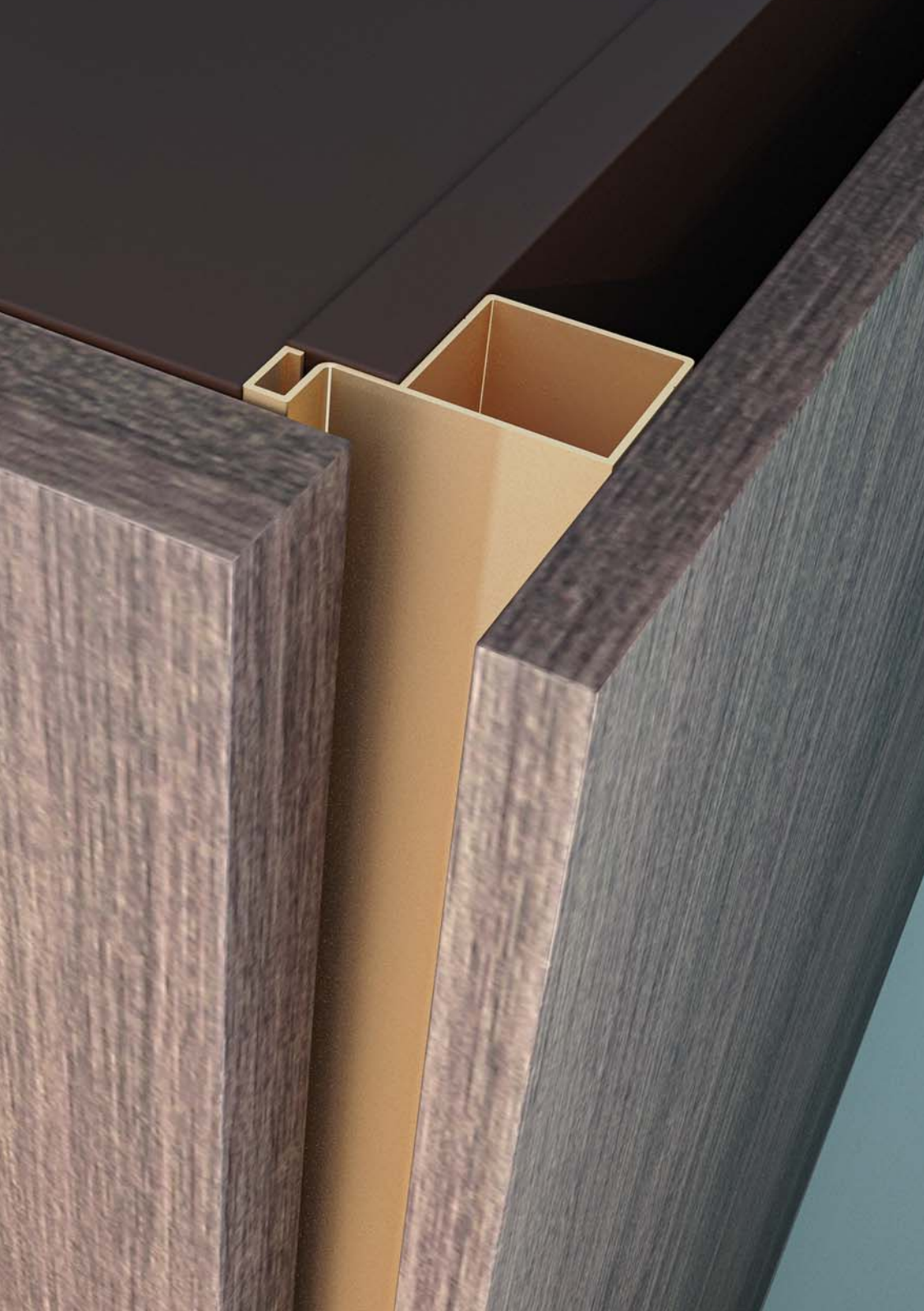

	 C mm	 L mm			
zum Zuschneiden pour la découpe para cortar	3000		schwarz matt, noir mat, negro mate	Gold, or, oro	Aluminium, aluminium, aluminio
			PA-VELLO-TJ3M-20M	PA-VELLO-TJ3M-21	





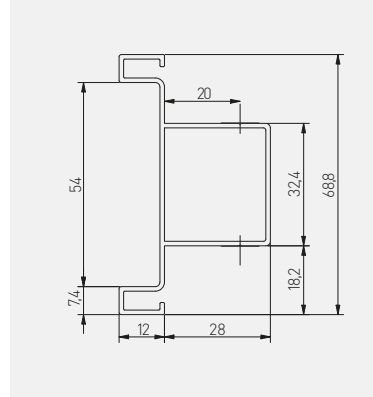

Griffloses System VELLO  
 Système d'ouverture sans poignée VELLO  
 Sistema sin tirador VELLO

NEW



 C mm	 L mm				
		Aluminium, aluminium, aluminio	Edelstahl optik, acier brossé, acero pulido	weiß, blanc, blanco	
zum Zuschneiden pour la découpe para cortar	3000	PA-VELLO-TD3M-05	PA-VELLO-TD3M-06	PA-VELLO-TD3M-10	Aluminium, aluminium, aluminio

 C mm	 L mm			
		schwarz matt, noir mat, negro mate	Gold, or, oro	
zum Zuschneiden pour la découpe para cortar	3000	PA-VELLO-TD3M-20M	PA-VELLO-TD3M-21	Aluminium, aluminium, aluminio

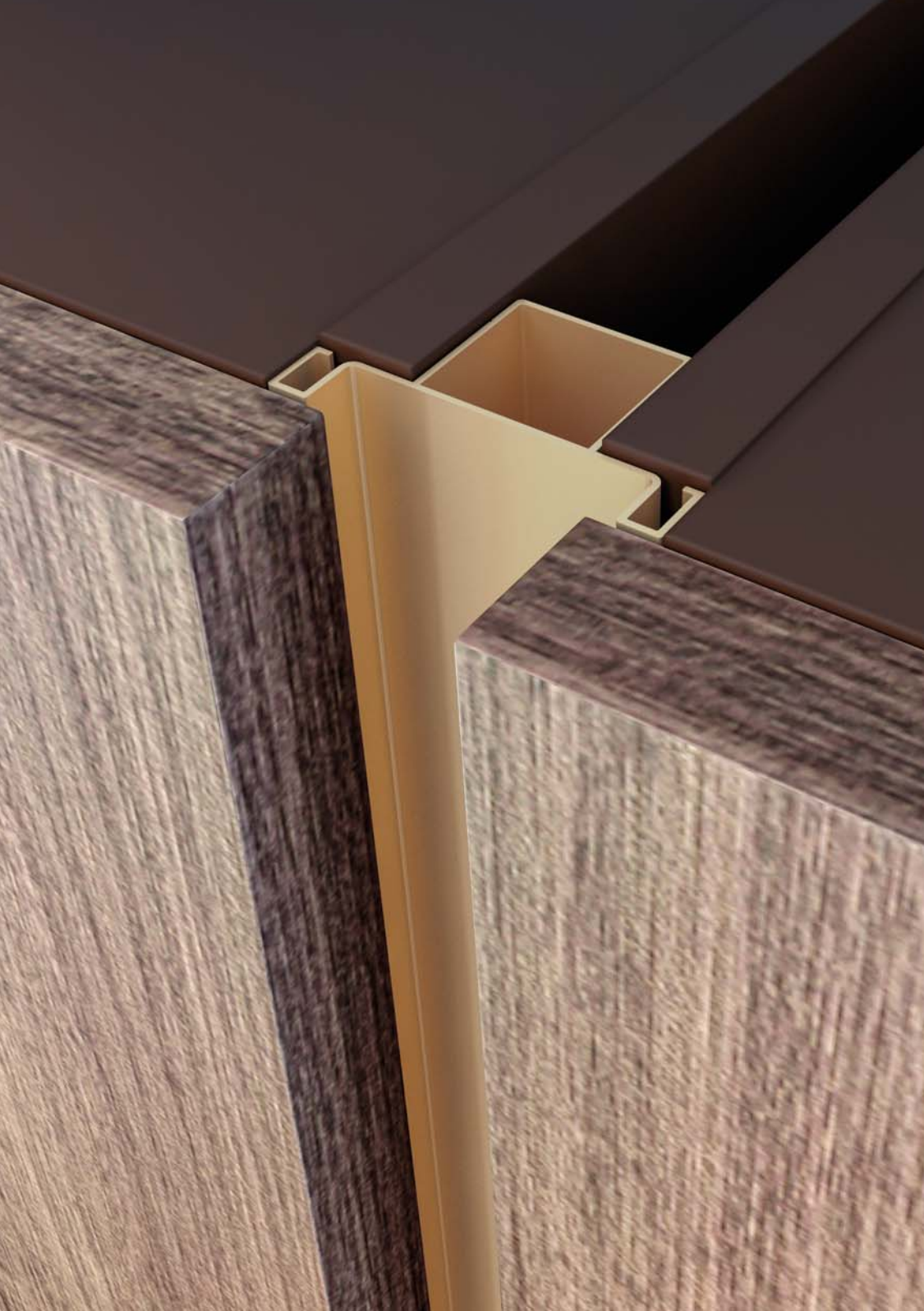

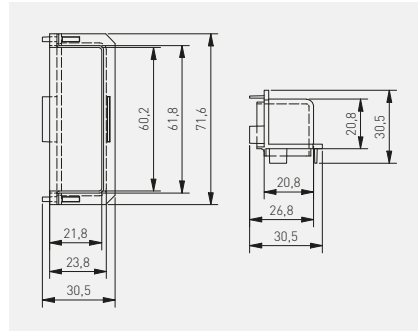

Griffloses System VELLO  
Système d'ouverture sans poignée VELLO  
Sistema sin tirador VELLO

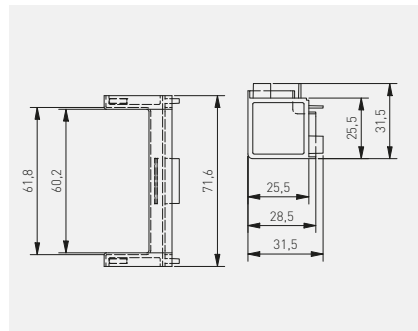

			
Aluminium, aluminium, aluminio	inox inox inox	weiß, blanc, blanco	Kunststoff, plastique, plástico
PA-LACZVELLO-CIN-05	PA-LACZVELLO-CIN-06	PA-LACZVELLO-CIN-10M	
			
schwarz matt, noir mat, negro mate	Gold, or, oro	Kunststoff, plastique, plástico	
PA-LACZVELLO-CIN-20M	PA-LACZVELLO-CIN-21		

Griffloses System VELLO  
Système d'ouverture sans poignée VELLO  
Sistema sin tirador VELLO



			
Aluminium, aluminium, aluminio	inox inox inox	weiß, blanc, blanco	Kunststoff, plastique, plástico
PA-LACZVELLO-COUT-05	PA-LACZVELLO-COUT-06	PA-LACZVELLO-COUT-10M	
			
schwarz matt, noir mat, negro mate	Gold, or, oro	Kunststoff, plastique, plástico	
PA-LACZVELLO-COUT-20M	PA-LACZVELLO-COUT-21		

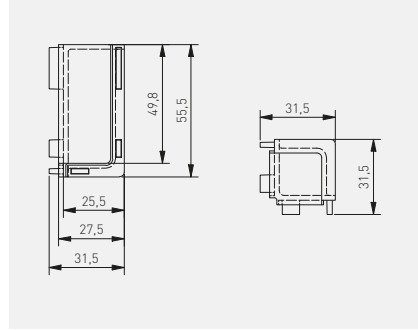

Griffloses System VELLO  
Système d'ouverture sans poignée VELLO  
Sistema sin tirador VELLO

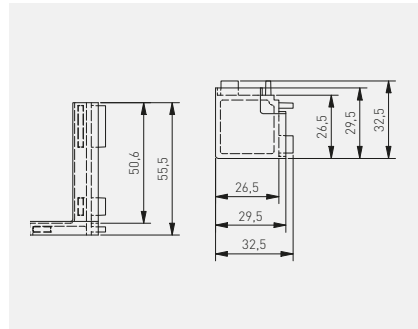

			
Aluminium, aluminium, aluminio	inox inox inox	weiß, blanc, blanco	Kunststoff, plastique, plástico
PA-LACZVELLO-LIN-05	PA-LACZVELLO-LIN-06	PA-LACZVELLO-LIN-10M	
			
schwarz matt, noir mat, negro mate	Gold, or, oro	Kunststoff, plastique, plástico	
PA-LACZVELLO-LIN-20M	PA-LACZVELLO-LIN-21		

Griffloses System VELLO  
Système d'ouverture sans poignée VELLO  
Sistema sin tirador VELLO



			
Aluminium, aluminium, aluminio	inox inox inox	weiß, blanc, blanco	Kunststoff, plastique, plástico
PA-LACZVELLO-LOUT-05	PA-LACZVELLO-LOUT-06	PA-LACZVELLO-LOUT-10M	
			
schwarz matt, noir mat, negro mate	Gold, or, oro	Kunststoff, plastique, plástico	
PA-LACZVELLO-LOUT-20M	PA-LACZVELLO-LOUT-21		

Knopf J4  
Bouton J4  
Pomo J4

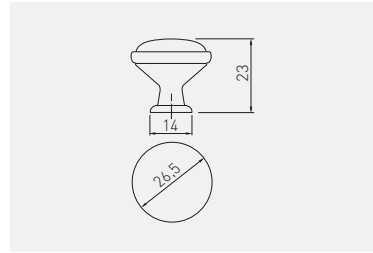

Motiv motif motivo	Altmessing laiton ancien latón envejecido	Altsilber argent ancien plata envejecida	ZnAl + Porzellan ZnAl + porcelaine ZnAl + porcelana
autumn rose	GP-0728-J4-B	-	
spring flower	GP-0728-J4-R	-	
blue rose	GP-0728-J4-A-04	GP-0728-J4-A-07	
orient gold	GP-0728-J4-C-04	-	



autumn rose



spring flower



blue rose



orient gold

Griff 728B  
Poignée 728B  
Tirador 728B

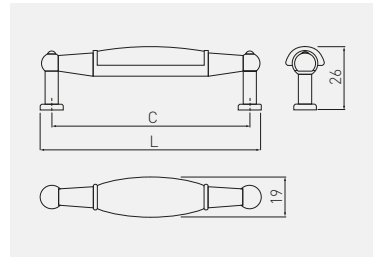

Motiv motif motivo	C mm	L mm	Altmessing laiton ancien latón envejecido	ZnAl + Porzellan ZnAl + porcelaine ZnAl + porcelana
spring flower	96	106	UP-WP0728-BR	
country	96	106	UP-WP0728-BK	
ornament	96	106	UP-WP0728-BX	
autumn rose	96	106	UP-WP0728-BB	



spring flower



country



ornament



autumn rose



Griff 728P  
Poignée 728P  
Tirador 728P

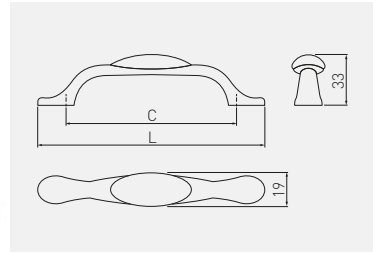

Motiv motif motivo	C mm	L mm	Altmessing laiton ancien latón envejecido	Altsilber argent ancien plata envejecida	ZnAl + Porzellan ZnAl + porcelaine ZnAl + porcelana
blue rose	96	125	UP-WP0728-PA-04	UP-WP0728-PA-07	
orient gold	96	125	UP-WP0728-PC-04	-	
ornament	96	125	UP-WP0728-PX	-	
autumn rose	96	125	UP-WP0728-PB	-	
spring flower	96	125	UP-WP0728-PR	-	
country	96	125	UP-WP0728-PK	-	
milky	96	125	UP-WP0728-P0	-	



blue rose



orient gold



ornament



autumn rose



spring flower



country



milky

Griff ALATRI  
Poignée ALATRI  
Tirador ALATRI

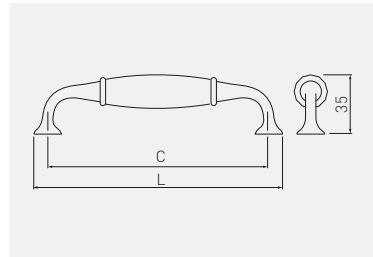

C mm	L mm	Altmessing laiton ancien latón envejecido	ZnAl + Porzellan ZnAl + porcelaine ZnAl + porcelana
128	144	UZ-ALATR-128-04	

Griff RETRIS  
Poignée RETRIS  
Tirador RETRIS

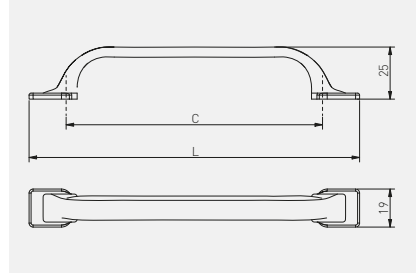

 C mm	 L mm				
		Altmessing laiton ancien latón envejecido	Altsilber argent ancien plata envejecida	schwarz matt, noir mat, negro mate	 ZnAl
128	165	UZ-RETRIS-128-04	UZ-RETRIS-128-07	UZ-RETRIS-128-20M	



Griff MARSALA  
Poignée MARSALA  
Tirador MARSALA

NEW

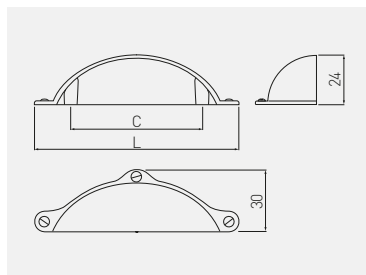

C mm	L mm				
64	99,5	Altsilber argent ancien plata envejecida	gebürstetes Altmessing, laiton antique brossé, latón envejecido pulido,	weiß matt, blanco mat, blanco mate	ZnAl
		UZ-MARSA-64-07	UZ-MARSA-64-09	UZ-MARSA-64-10M	

C mm	L mm				
64	99,5	gebürstetes Titan titane brossé titanio pulido	Kupfer cuivre cobre	Gold gebürstet, or brossé, oro cepillado	schwarz matt, noir mat, negro mate
		UZ-MARSA-64-11	UZ-MARSA-64-15	UZ-MARSA-64-18	UZ-MARSA-64-20M



Griff UZ-12  
Poignée UZ-12  
Tirador UZ-12

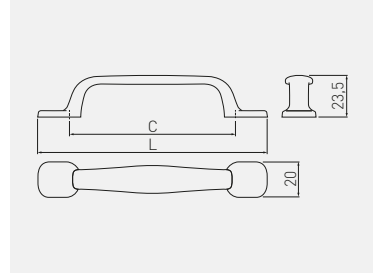

C mm	L mm				
96	131	Altmessing laiton ancien latón envejecido	Altsilber argent ancien plata envejecida	schwarz matt, noir mat, negro mate	ZnAl
		UZ-12-096-04N	UZ-12-096-07	UZ-12-096-20M	



Knopf CENTO  
Bouton CENTO  
Tirador CENTO

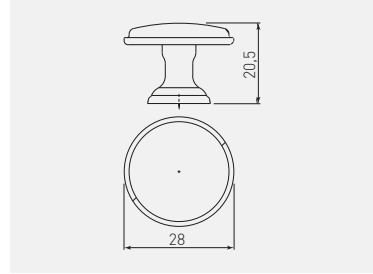

SHAPE ART

	Altmessing laiton ancien latón envejecido	Altsilber argent ancien plata envejecida	Altkupfer, cuivre ancien, cobre envejecido	schwarz matt, noir mat, negro mate	ZnAl
<b>Knopf bouton pomo</b>	GZ-CENTO-1-04	GZ-CENTO-1-07	GZ-CENTO-1-14	GZ-CENTO-1-20M	



Knopf IMPERIA  
Bouton IMPERIA  
Tirador IMPERIA

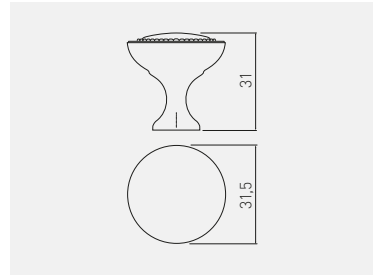

	Nickel matt satiné satinado	gebürstetes Titan titane brossé titanio pulido	schwarz matt, noir mat, negro mate	Aluminium, aluminium, aluminio
<b>Knopf bouton pomo</b>	GA-IMPER-1-02B	GA-IMPER-1-11	GA-IMPER-1-20M	

Griff VASTO  
Poignée VASTO  
Tirador VASTO

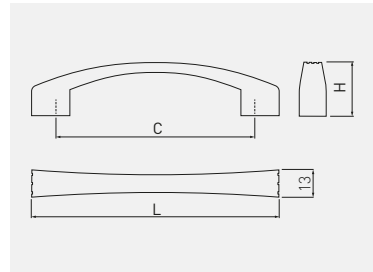

C  
mm

L  
mm

H  
mm



			gebürstetes Altmessing, laiton antique brossé, latón envejecido pulido,	ZnAl
96	120	26	UZ-VASTO-96-09	
128	151	27	UZ-VASTO-128-09	

Griff SONET  
Bouton SONET  
Pomo SONET

NEW

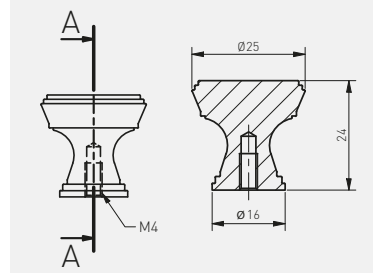





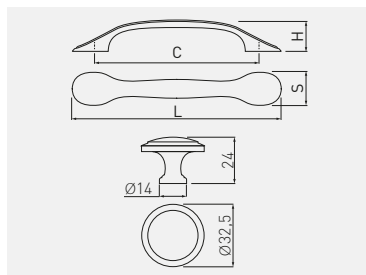

	Altsilber argent ancien plata envejecida	Gold gebürstet, or brossé, oro cepillado	schwarz matt, noir mat, negro mate	ZnAl
<b>Knopf bouton pomo</b>	GZ-SONET-1-07	GZ-SONET-1-18	GZ-SONET-1-20M	

RETRO









Griff PALERMO  
Poignée PALERMO  
Tirador PALERMO

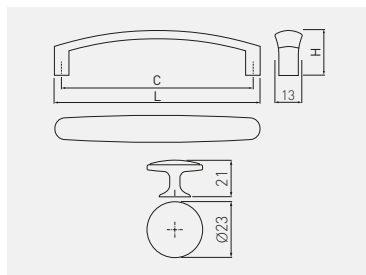

 C mm	 L mm	 H mm	 S mm		
				Altsilber argent ancien plata envejecida	ZnAl
96	127	22,5	23	UZ-PALER-96-07	
128	159	23	25	UZ-PALER-128-07	
Knopf bouton pomo	-	-	-	GZ-PALER-1-07	

Griff OLBIA  
Poignée OLBIA  
Tirador OLBIA



 C mm	 L mm	 H mm		
			Altmessing laiton ancien latón envejecido	ZnAl
96	103	22	UZ-OLBIA-96-04	
128	136	24	UZ-OLBIA-128-04	
Knopf bouton pomo	-	-	GZ-OLBIA-1-04	



Griff ARDEA  
Bouton ARDEA  
Pomo ARDEA

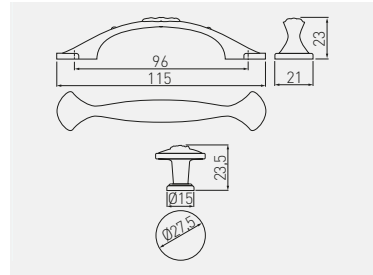

C mm	L mm		
96	115	Altmetting laiton ancien latón envejecido	ZnAl
Knopf bouton pomo	-	GZ-ARDEA-1-09	

Griff WERONA  
Poignée WERONA  
Tirador WERONA

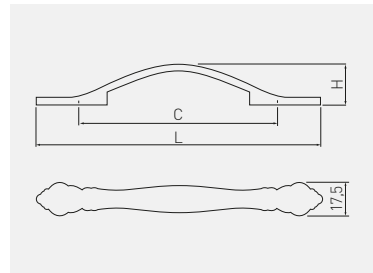

C mm	L mm	H mm				
96	148	24,5	Altmetting laiton ancien latón envejecido	gebürstetes Altmetting, laiton antique brossé, latón envejecido pulido,	schwarz, Chrom noir, chrome, negro, cromado	ZnAl
128	183	26,5	UZ-WERON-128-04	UZ-WERON-128-09	UZ-WERON-128-12	

Griff ARCHE\*  
Poignée ARCHE\*  
Tirador ARCHE\*

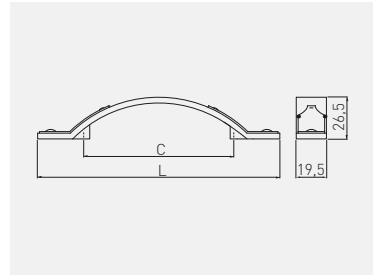

 C mm	 L mm		
		gebürstetes Altmessing, laiton antique brossé, latón envejecido pulido,	ZnAl
96	155	UZ-ARCH096-AEB	

\*Produkt erhältlich auf individuelle Bestellung / Produit disponible sur demande / Producto disponible bajo demanda

Griff AREZO  
Poignée AREZO  
Tirador AREZO

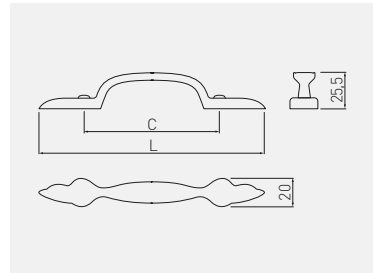

 C mm	 L mm		
		Altmessing laiton ancien latón envejecido	ZnAl
96	160	UZ-AREZO-96-04	

Griff ABIATE  
Poignée ABIATE  
Tirador ABIATE

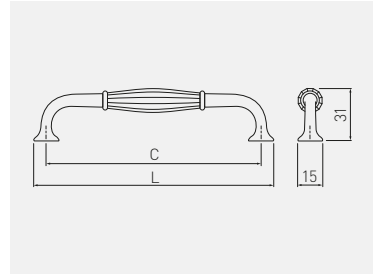

 C mm	 L mm		
128	143	Altmessing laiton ancien latón envejecido	ZnAl
UZ-ABIAT-128-04			

Griff ADRIN  
Poignée ADRIN  
Tirador ADRIN

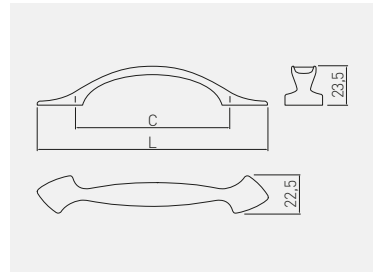

 C mm	 L mm		
96	139	Altmessing laiton ancien latón envejecido	ZnAl
UZ-ADRIN-96-04			

Griff ACERA  
Poignée ACERA  
Tirador ACERA

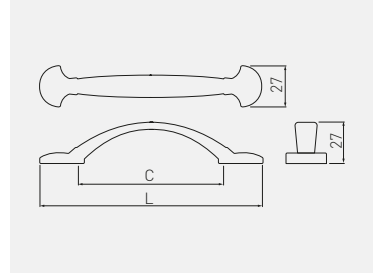

C mm	L mm		
96	147	Altmessing laiton ancien latón envejecido	ZnAl
		UZ-ACERA-96-04	

Griff RENNES  
Poignée RENNES  
Tirador RENNES

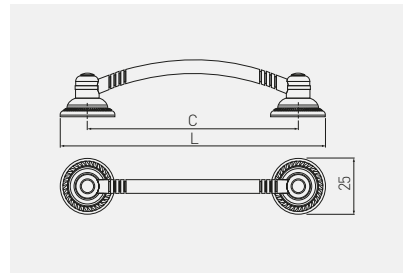

C mm	L mm		
96	121	Altmessing laiton ancien latón envejecido	ZnAl
		UZ-REN096-04A	

Griff ROYAL  
Poignée ROYAL  
Tirador ROYAL

GZ-ROYAL3-1-10-03



UZ-ROYAL4-96-03



UZ-ROYAL1-96-10-03



UZ-ROYAL2-96-10-03







UZ-ROYAL3-96-10-03

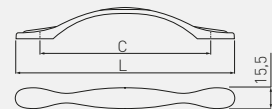
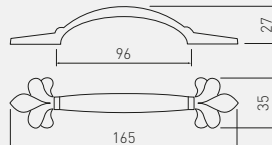
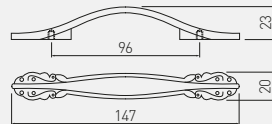
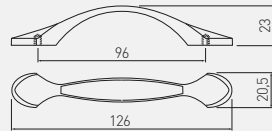
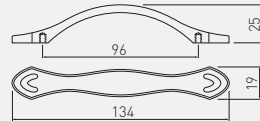
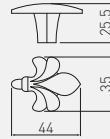



UZ-ROYAL5-128-10-03



	 i	 C mm	 L mm		
Motiv motif motivo				weiß, Gold blanc, or blanco, zlato	ZnAl
latina		96	126	UZ-ROYAL1-96-10-03	
werona		96	147	UZ-ROYAL2-96-10-03	
genova		96	165	UZ-ROYAL3-96-10-03	
reggio		96	134	UZ-ROYAL4-96-03	
piano		96	131	UZ-ROYAL5-96-10-03	
		128	164	UZ-ROYAL5-128-10-03	
genova		Knopf bouton pomo	35	GZ-ROYAL3-1-10-03	

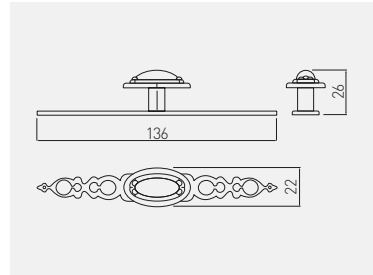

Knopf UZ-WP146  
Bouton UZ-WP146  
Tirador UZ-WP146

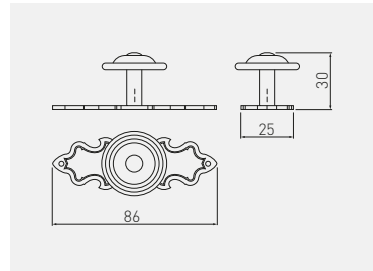

		
	Altmetting laiton ancien latón envejecido	ZnAl
<b>Knopf bouton pomo</b>	UZ-WP1146-04	

Knopf GZ-1136  
Bouton GZ-1136  
Tirador GZ-1136



		
	Altmetting laiton ancien latón envejecido	ZnAl
<b>Knopf bouton pomo</b>	GZ-WP1136-04	

Knopf GZ-1148  
 Bouton GZ-1148  
 Tirador GZ-1148

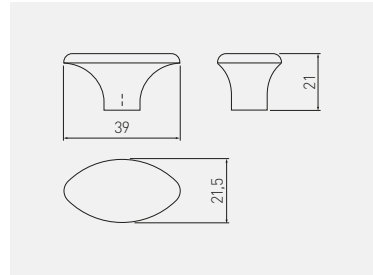

	Altmetzing laiton ancien latón envejecido	ZnAl
<b>Knopf bouton pomo</b>	GZ-WP1148-04	

Knopf GZ-1152\*  
 Bouton GZ-1152\*  
 Tirador GZ-1152\*

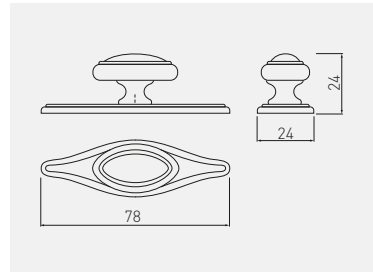

	Altmetzing laiton ancien latón envejecido	ZnAl
<b>Knopf bouton pomo</b>	GZ-WP1152-04	



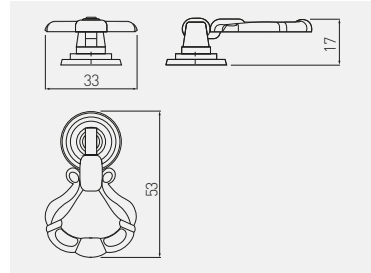

Türklopfert KT-1147  
Knocker KT-1147  
Tirador KT-1147

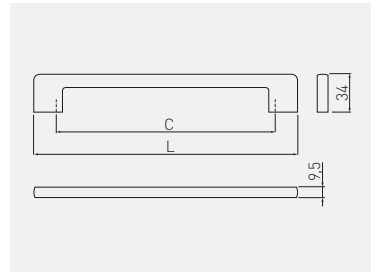

		
	Altmessing laiton ancien latón envejecido	ZnAl
<b>Türklopfert heurtoir pomo</b>	KT-WP1147-04	

Griff UZ-CRA14\*  
Poignée UZ-CRA14\*  
Tirador UZ-CRA14\*







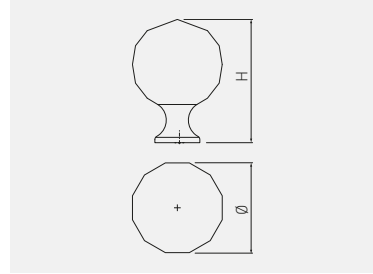

			
mm	mm	Chrom, chrome, cromado	ZnAl
<b>128</b>	<b>166</b>	UZ-CRA14-128	
<b>192</b>	<b>230</b>	UZ-CRA14-192	
<b>320</b>	<b>358</b>	UZ-CRA14-320	

\*Produkt erhältlich auf individuelle Bestellung / Produit disponible sur demande / Producto disponible bajo demanda









Knopf GZ-CRPA  
Bouton GZ-CRPA  
Tirador GZ-CRPA

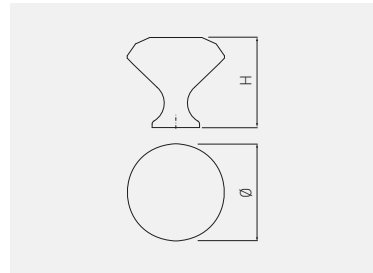

 mm	 mm				
20	33	Chrom, weißer Kristall chrome, blanc cristal cromado, cristal blanco	Chrom, schwarzer Kristall chrome, noir cristal cromado, cristal negro	Messing, weißer Kristall laiton, blanc cristal latón, cristal blanco	ZnAl + Glas ZnAl + verre ZnAl + vidrio
25	37	GZ-CRPA20-01	-	-	
30	44	GZ-CRPA30-01	GZ-CRPA30-A1	GZ-CRPA30-03	
40	55	GZ-CRPA40-01	-	-	





Knopf GZ-CRPB  
Bouton GZ-CRPB  
Tirador GZ-CRPB

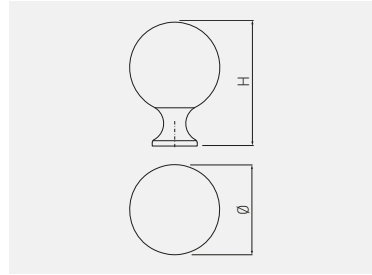

 mm	 mm				
20	26	Chrom, weißer Kristall chrome, blanc cristal cromado, cristal blanco	Chrom, schwarzer Kristall chrome, noir cristal cromado, cristal negro	Messing, weißer Kristall laiton, blanc cristal latón, cristal blanco	ZnAl + Glas ZnAl + verre ZnAl + vidrio
25	28	GZ-CRPB20-01	-	-	
30	30	GZ-CRPB30-01	GZ-CRPB30-A1	GZ-CRPB30-03	
40	38	GZ-CRPB40-01	GZ-CRPB40-A1	-	





Knopf GZ-CRPC  
Bouton GZ-CRPC  
Tirador GZ-CRPC

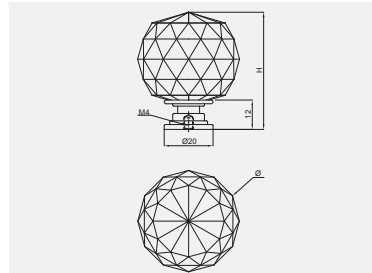

 mm	 mm		
		Chrom, weißer Kristall chrome, blanc cristal cromado, cristal blanco	ZnAl + Glas ZnAl + verre ZnAl + vidrio
30	43	GZ-CRPC30-01	

Knopf GZ-CRPJ  
Bouton GZ-CRPJ  
Tirador GZ-CRPJ



 mm	 mm		
		Chrom, weißer Kristall chrome, blanc cristal cromado, cristal blanco	ZnAl + Glas ZnAl + verre ZnAl + vidrio
30	43	ID-GZ-CRPJ30-01	
40	49	ID-GZ-CRPJ40-01	



Griff KID  
Poignée KID  
Tirador KID



BLOCK



CLOUD



STAR



BUTTON



FLAMING



HEART



CROWN



TWITT

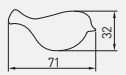
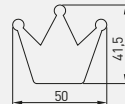
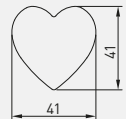
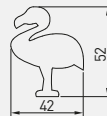
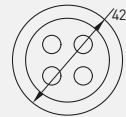
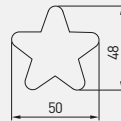
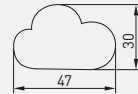
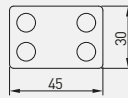

	grün vert verde	blau bleu azul	rot rouge rojo	grau, gris, gris	gelb jaune amarillo	pink rose rosa	
<b>block</b>	UM-BLOCK-ZL	UM-BLOCK-NB	UM-BLOCK-CZ	-	-	-	Gummi + ZnAl rubber + ZnAl goma + ZnAl
<b>cloud</b>	-	UM-CLOUD-NB	-	UM-CLOUD-SZ	-	-	
<b>star</b>	-	UM-STAR-NB	-	-	UM-STAR-ZT	UM-STAR-RZ	
<b>button</b>	-	UM-BUTTON-NB	-	UM-BUTTON-SZ	-	-	
<b>flaming</b>	-	-	-	UM-FLAMING-SZ	-	UM-FLAMING-RZ	
<b>heart</b>	-	-	-	-	-	UM-HEART-RZ	
<b>crown</b>	-	-	-	-	-	UM-CROWN-RZ	
<b>twitt</b>	UM-TWITT-ZL	-	-	UM-TWITT-SZ	-	-	



Griff KID WILD  
Poignée KID WILD  
Tirador KID WILD



UM-KID-P-001



UM-KID-Q-001



UM-KID-U-001

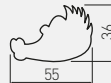

Elefant / éléphant / elefante	UM-KID-P-001	Gummi + ZnAl rubber + ZnAl goma + ZnAl
Krokodil / crocodile / cocodrilo	UM-KID-Q-001	
Panda / panda / Panda	UM-KID-U-001	

Griff KID PLAY  
Poignée KID PLAY  
Tirador KID PLAY



UM-KID-C-001



UM-KID-D-001



UM-KID-E-001



Blume / fleur / flor	UM-KID-C-001	Gummi + ZnAl rubber + ZnAl goma + ZnAl
Auto / automobile / coche	UM-KID-D-001	
Ball / ballon de football / balón	UM-KID-E-001	

Griff KID FARM  
Poignée KID FARM  
Tirador KID FARM



UM-KID-W-001



UM-KID-X-001



UM-KID-Z-001



UM-UNICORN-RZ



Pferd / cheval / caballito	UM-KID-W-001	Gummi + ZnAl rubber + ZnAl goma + ZnAl
Kaninchen / lapin / conejo	UM-KID-X-001	
Hündchen / chien / perrito	UM-KID-Z-001	
Einhorn / Licorne / Unicornio	UM-UNICORN-RZ	

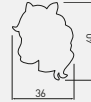

Kleiderhaken TOLEDO A0  
 Crochet de suspension TOLEDO A0  
 Percha TOLEDO A0

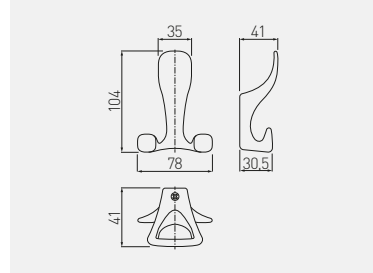

WZ-TOLED-A0-01	Chrom / chrome / cromado	ZnAl
WZ-TOLED-A0-02	Nickel matt / satiné / satinado	
WZ-TOLED-A0-05	Aluminium / aluminium / aluminio	
WZ-TOLED-A0-06	Edelstahloptik / acier brossé / acero pulido	
WZ-TOLED-A0-20M	schwarz matt / noir mat / negro mate	

Kleiderhaken TOLEDO B0  
 Crochet de suspension TOLEDO B0  
 Percha TOLEDO B0

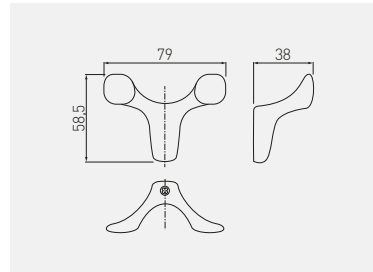

WZ-TOLED-B0-01	Chrom / chrome / cromado	ZnAl
WZ-TOLED-B0-02	Nickel matt / satiné / satinado	
WZ-TOLED-B0-05	Aluminium / aluminium / aluminio	
WZ-TOLED-B0-06	Edelstahloptik / acier brossé / acero pulido	
WZ-TOLED-B0-20M	schwarz matt / noir mat / negro mate	



Kleiderhaken TOLEDO C0  
 Crochet de suspension TOLEDO C0  
 Percha TOLEDO C0

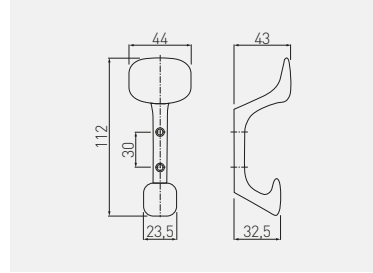

WZ-TOLED-C0-01	Chrom / chrome / cromado	ZnAl
WZ-TOLED-C0-02	Nickel matt / satiné / satinado	
WZ-TOLED-C0-05	Aluminium / aluminium / aluminio	
WZ-TOLED-C0-06	Edelstahloptik / acier brossé / acero pulido	
WZ-TOLED-C0-20M	schwarz matt / noir mat / negro mate	



Kleiderhaken WALENCIA  
 Crochet de suspension WALENCIA  
 Percha WALENCIA

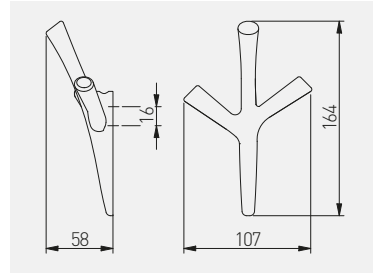

WZ-WALENCIA-01	Chrom / chrome / cromado	ZnAl
WZ-WALENCIA-06	Edelstahloptik / acier brossé / acero pulido	
WZ-WALENCIA-20M	schwarz matt / noir mat / negro mate	

Kleiderhaken CORDOBA  
 Crochet de suspension CORDOBA  
 Percha CORDOBA

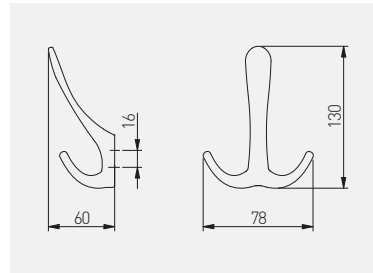

WZ-CORDOBA-01	Chrom / chrome / cromado	ZnAl
WZ-CORDOBA-06	Edelstahloptik / acier brossé / acero pulido	
WZ-CORDOBA-20M	schwarz matt / noir mat / negro mate	

Kleiderhaken K2201  
Crochet de suspension K2201  
Percha K2201

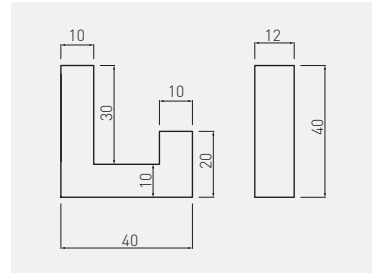

WZ-K2201-01	Chrom / chrome / cromado	ZnAl
WZ-K2201-06	Edelstahloptik / acier brossé / acero pulido	
WZ-K2201-CZ	schwarz / noir / negro	

Kleiderhaken K2202  
Crochet de suspension K2202  
Percha K2202

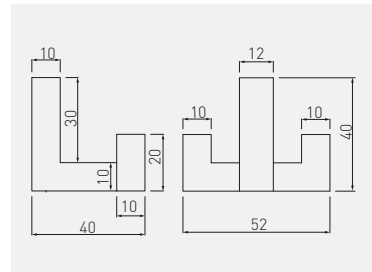

WZ-K2202-01	Chrom / chrome / cromado	ZnAl
WZ-K2202-06	Edelstahloptik / acier brossé / acero pulido	
WZ-K2202-CZ	schwarz / noir / negro	

Kleiderhaken CAPITAL  
 Crochet de suspension CAPITAL  
 Percha CAPITAL

NEW

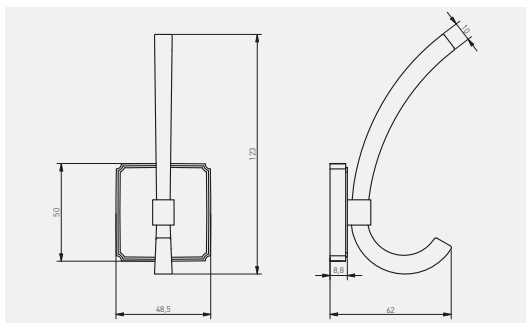

WZ-CAPITAL-18	Gold gebürstet / or brossé / oro cepillado	ZnAl
WZ-CAPITAL-20M	schwarz matt / noir mat / negro mate	

Kleiderhaken 804  
 Crochet de suspension 804  
 Percha 804

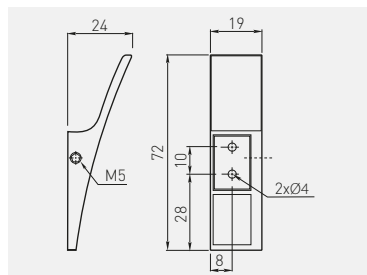

WZ-804-20-01	Chrom / chrome / cromado	ZnAl
WZ-804-20-05	Aluminium / aluminium / aluminio	
WZ-804-20-06	Edelstahl optik / acier brossé / acero pulido	



## Kleiderhaken K23-A0

### Crochet de suspension K23-A0

### Percha K23-A0

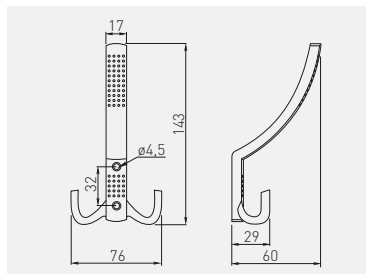

WZ-A0-K23-01	Chrom / chrome / cromado	ZnAl
WZ-A0-K23-02	Nickel matt / satiné / satinado	
WZ-A0-K23-03	Messing / laiton / latón	
WZ-A0-K23-04	Altmessing / laiton ancien / latón envejecido	
WZ-A0-K23-05	Aluminium / aluminium / aluminio	
WZ-A0-K23-06*	Edelstahlloptik / acier brossé / acero pulido	
WZ-A0-K23-07	Altsilber / argent ancien / plata envejecida	
WZ-A0-K23-20	schwarz matt / noir mat / negro mate	

\*Produkt erhältlich auf individuelle Bestellung / Produit disponible sur demande / Producto disponible bajo demanda

## Kleiderhaken K23-B0

### Crochet de suspension K23-B0

### Percha K23-B0

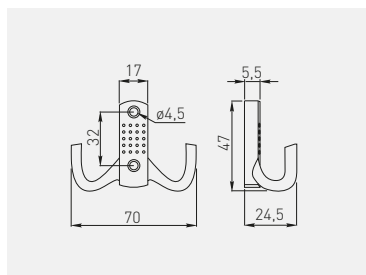

WZ-B0-K23-01	Chrom / chrome / cromado	ZnAl
WZ-B0-K23-02	Nickel matt / satiné / satinado	
WZ-B0-K23-03	Messing / laiton / latón	
WZ-B0-K23-04	Altmessing / laiton ancien / latón envejecido	
WZ-B0-K23-05	Aluminium / aluminium / aluminio	
WZ-B0-K23-06*	Edelstahlloptik / acier brossé / acero pulido	
WZ-B0-K23-07	Altsilber / argent ancien / plata envejecida	
WZ-B0-K23-20	schwarz matt / noir mat / negro mate	

\*Produkt erhältlich auf individuelle Bestellung / Produit disponible sur demande / Producto disponible bajo demanda

Kleiderhaken K24-A0  
Crochet de suspension K24-A0  
Percha K24-A0

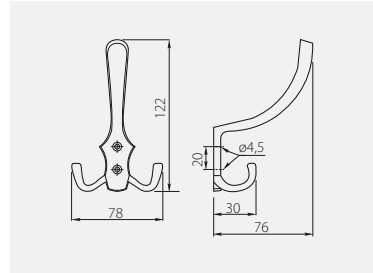

WZ-A0-K24-01	Chrom / chrome / cromado	ZnAl
WZ-A0-K24-02	Nickel matt / satiné / satinado	
WZ-A0-K24-03	Messing / laiton / latón	
WZ-A0-K24-04	Altmessing / laiton ancien / latón envejecido	
WZ-A0-K24-05	Aluminium / aluminium / aluminio	
WZ-A0-K24-07	Altsilber / argent ancien / plata envejecida	
WZ-A0-K24-20	schwarz matt / noir mat / negro mate	

Kleiderhaken K24-B0  
Crochet de suspension K24-B0  
Percha K24-B0

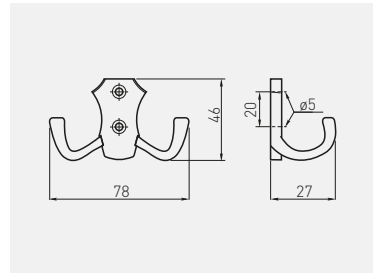

WZ-B0-K24-01	Chrom / chrome / cromado	ZnAl
WZ-B0-K24-02	Nickel matt / satiné / satinado	
WZ-B0-K24-03	Messing / laiton / latón	
WZ-B0-K24-04	Altmessing / laiton ancien / latón envejecido	
WZ-B0-K24-05	Aluminium / aluminium / aluminio	
WZ-B0-K24-07	Altsilber / argent ancien / plata envejecida	
WZ-B0-K24-20	schwarz matt / noir mat / negro mate	

Kleiderhaken K24-C0  
 Crochet de suspension K24-C0  
 Percha K24-C0

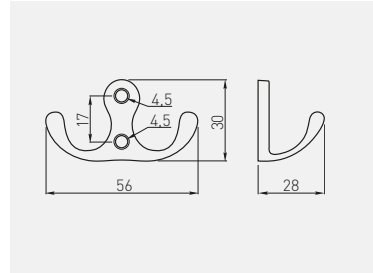

WZ-C0-K24-01	Chrom / chrome / cromado	ZnAl
WZ-C0-K24-02	Nickel matt / satiné / satinado	
WZ-C0-K24-03	Messing / laiton / latón	
WZ-C0-K24-04	Altmessing / laiton ancien / latón envejecido	
WZ-C0-K24-05	Aluminium / aluminium / aluminio	
WZ-C0-K24-20	schwarz matt / noir mat / negro mate	

Kleiderhaken MALAGA A0  
 Crochet de suspension MALAGA A0  
 Percha MALAGA A0

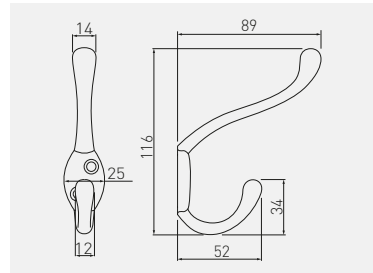

WA-MALAG-A0-01	Chrom / chrome / cromado	Aluminium / aluminium / aluminio
WA-MALAG-A0-02	Nickel matt / satiné / satinado	
WA-MALAG-A0-05	Aluminium / aluminium / aluminio	
WA-MALAG-A0-20	schwarz / noir / negro	



Kleiderhaken MALAGA B0  
 Crochet de suspension MALAGA B0  
 Percha MALAGA B0

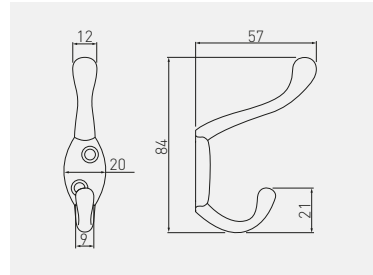

WA-MALAG-B0-01	Chrom / chrome / cromado	Aluminium, aluminium, aluminio
WA-MALAG-B0-02	Nickel matt / satiné / satinado	
WA-MALAG-B0-05	Aluminium / aluminium / aluminio	
WA-MALAG-B0-20	schwarz / noir / negro	

Kleiderhaken MALAGA C0  
 Crochet de suspension MALAGA C0  
 Percha MALAGA C0

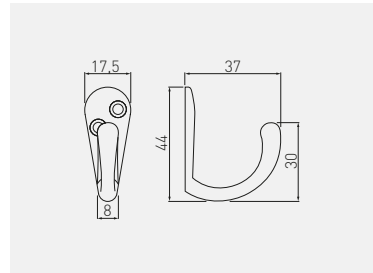

WZ-MALAG-C0-01	Chrom / chrome / cromado	ZnAl
WZ-MALAG-C0-02	Nickel matt / satiné / satinado	
WZ-MALAG-C0-05	Aluminium / aluminium / aluminio	
WZ-MALAG-C0-20	schwarz / noir / negro	

Kleiderhaken E18  
Crochet de suspension E18  
Percha E18

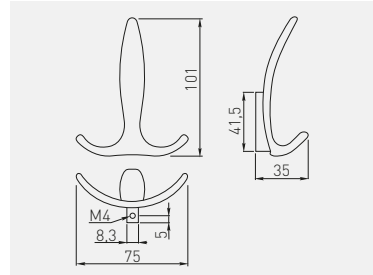

WZ-E-018-01	Chrom / chrome / cromado	ZnAl
WZ-E-018-02	Nickel matt / satiné / satinado	
WZ-E-018-05	Aluminium / aluminium / aluminio	
WZ-E-018-06	Edelstahloptik / acier brossé / acero pulido	
WZ-E-018-20M	schwarz matt / noir mat / negro mate	

Kleiderhaken Coruna-D  
Crochet de suspension Coruna-D  
Percha Coruna-D

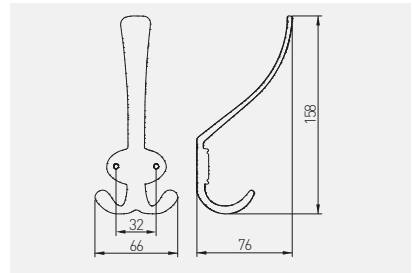

WZ-CORUNA-D-04	Altmessing / laiton ancien / latón envejecido	ZnAl
WZ-CORUNA-D-07	Altsilber / argent ancien / plata envejecida	
WZ-CORUNA-D-17	braun / bronze / marrón	
WZ-CORUNA-D-20M	schwarz matt / noir mat / negro mate	

Kleiderhaken Coruna-M  
 Crochet de suspension Coruna-M  
 Percha Coruna-M

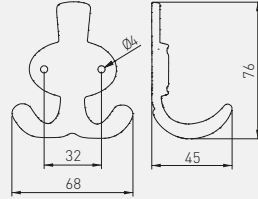

WZ-CORUNA-M-04	Altmessing / laiton ancien / latón envejecido	ZnAl
WZ-CORUNA-M-07	Altsilber / argent ancien / plata envejecida	
WZ-CORUNA-M-17	braun / bronze / marrón	
WZ-CORUNA-M-20M	schwarz matt / noir mat / negro mate	

Kleiderhaken MADRYT  
 Crochet de suspension MADRYT  
 Percha MADRYT

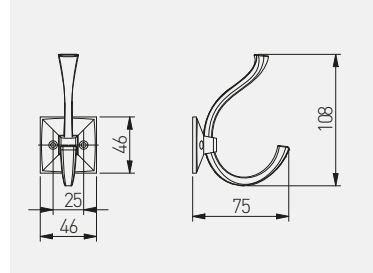

WZ-MADRYT-04	Altmessing / laiton ancien / latón envejecido	ZnAl
WZ-MADRYT-07	Altsilber / argent ancien / plata envejecida	
WZ-MADRYT-15	Altkupfer / cuivre ancien / cobre envejecido	
WZ-MADRYT-20M	schwarz matt / noir mat / negro mate	



Kleiderhaken CRAFT  
 Crochet de suspension CRAFT  
 Percha CRAFT

NEW

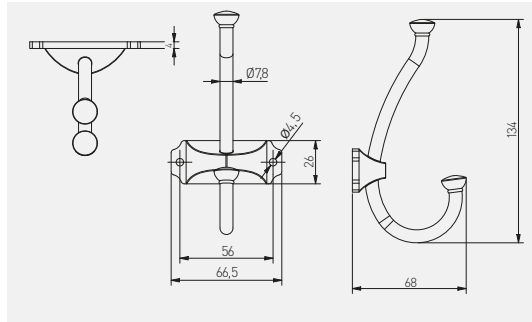

WZ-CRAFT-04	Altmessing / laiton ancien / latón envejecido	ZnAl
WZ-CRAFT-07	Altsilber / argent ancien / plata envejecida	
WZ-CRAFT-15	Altkupfer / cuivre ancien / cobre envejecido	
WZ-CRAFT-20M	schwarz matt / noir mat / negro mate	

Kleiderhaken ORVIETO A0  
 Crochet de suspension ORVIETO A0  
 Percha ORVIETO A0

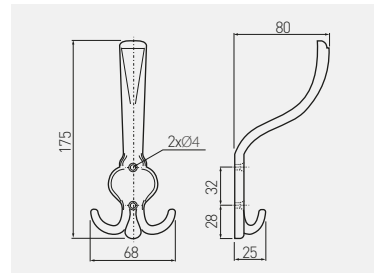

WZ-ORVIE-A0-09	gebürstetes Altmessing, laiton antique brossé, latón envejecido pulido,	ZnAl
----------------	---	------

RETRO

Kleiderhaken K24  
 Crochet de suspension K24  
 Percha K24

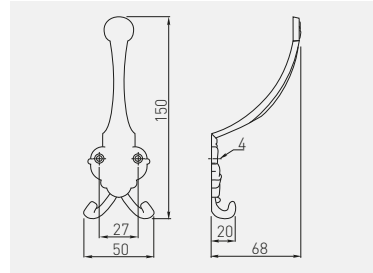

WZ-00-K24-04

Altmetessing / laiton ancien / latón envejecido

ZnAl



Kleiderhaken KID  
 Crochet de suspension KID  
 Percha KID



BLOCK



CLOUD



BALL



UNICORN

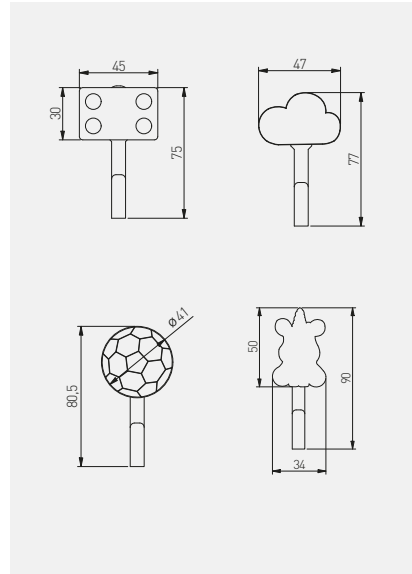

KID



	grün, vert, verde	blau bleu azul	rot rouge rojo	grau, gris, gris	gelb jaune amarillo	Schwarz und weiß noir et blanc en blanco y negro	pink rose rosa	
block	WM-BLOCK-ZL	WM-BLOCK-NB	WM-BLOCK-CZ	-	-	-	-	Gummi + ZnAl rubber + ZnAl goma + ZnAl
cloud	-	WM-CLOUD-NB	-	WM-CLOUD-SZ	-	-	-	
unicorn	-	-	-	-	-	-	WM-UNICORN-RZ	
ball	-	-	-	-	-	WM-BALL-CZ-B	-	

Regalbodenträger BELT  
Support d'étagère BELT  
Soporte para balda BELT

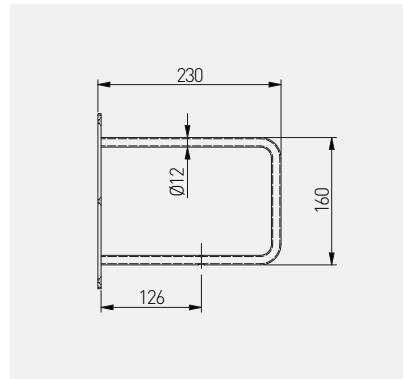

PP-BELT-20M



schwarz / noir / negro



Stahl / acier / acero



30

Regalbodenträger FLAT  
Support d'étagère FLAT  
Soporte para balda FLAT

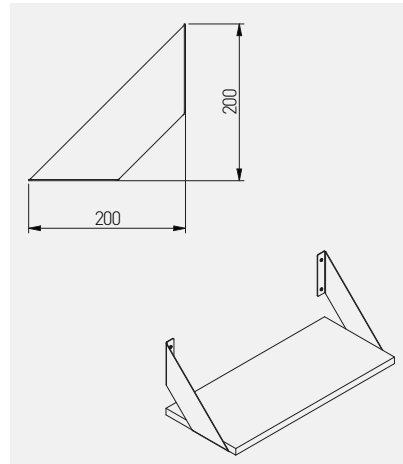

PP-FLAT-20M



schwarz / noir / negro



Stahl / acier / acero





15



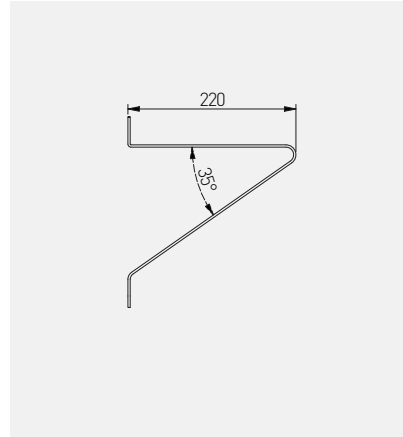

Regalbodenträger GALA  
Support d'étagère GALA  
Soporte para balda GALA



			
PP-GALA-20M	schwarz / noir / negro	Stahl / acier / acero	30

Regalbodenträger GINO  
Support d'étagère GINO  
Soporte para balda GINO

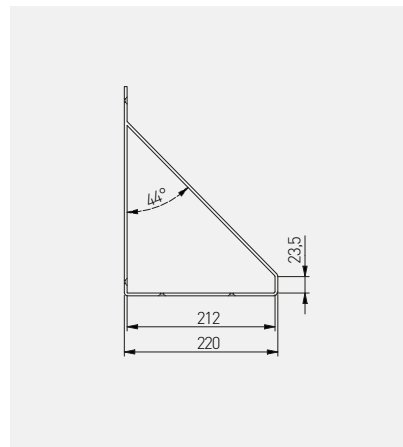

			
PP-GINO-20M	schwarz / noir / negro	Stahl / acier / acero	30



Regalbodenträger INGRID  
Support d'étagère INGRID  
Soporte para balda INGRID

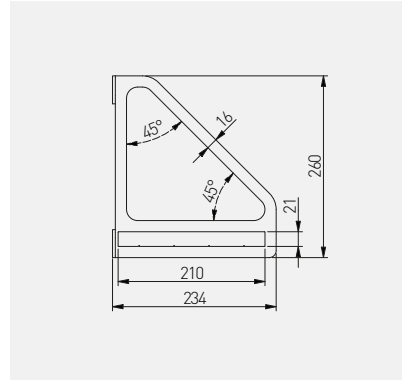

PP-INGRID-20M



schwarz / noir / negro



Stahl / acier / acero



20

Regalbodenträger NEO  
Support d'étagère NEO  
Soporte para balda NEO

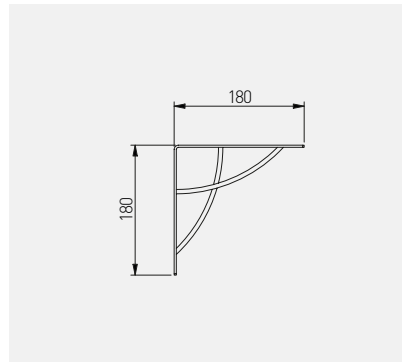

PP-NEO-20M



schwarz / noir / negro



Stahl / acier / acero



20



Regalbodenträger BAR  
Support d'étagère BAR  
Soporte para balda BAR

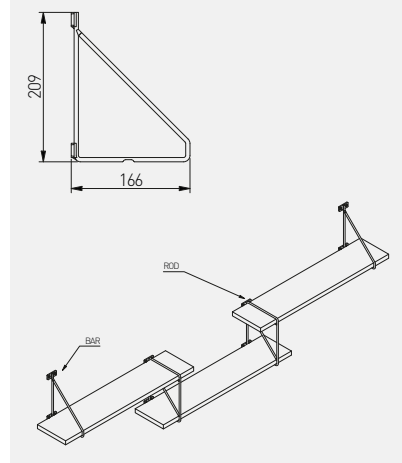

PP-BAR-20M



schwarz / noir / negro



Stahl / acier / acero



20

Regalbodenträger ROD  
Support d'étagère ROD  
Soporte para balda ROD

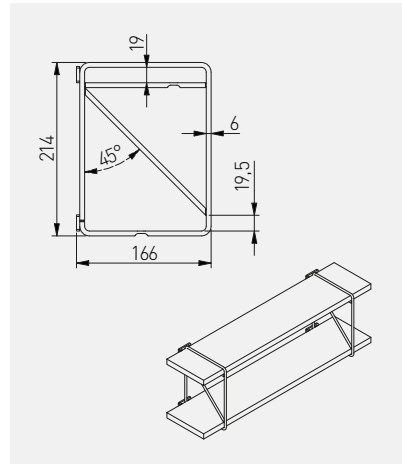

PP-ROD-20M



schwarz / noir / negro







Stahl / acier / acero

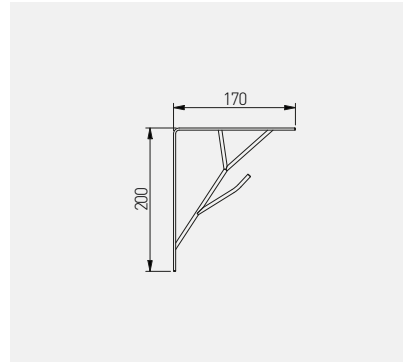

20

Regalbodenträger TREE  
Support d'étagère TREE  
Soporte para balda TREE



			
PP-TREE-20M	schwarz / noir / negro	Stahl / acier / acero	20

Regalbodenträger WIRE  
Support d'étagère WIRE  
Soporte para balda WIRE

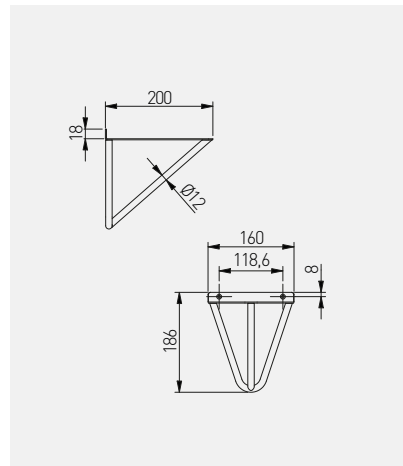

			
PP-WIRE-20M	schwarz / noir / negro	Stahl / acier / acero	30

Möbelfuß BD-150, höhenverstellbar  
 Pied réglable BD-150  
 Pata BD-150 ajustable

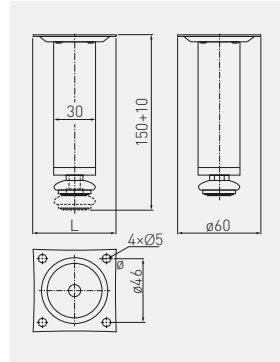

NM-BD-150-01	150 + 10	Chrom / chrome / cromado	Stahl / acier / acero	80
NM-BD-150-02		Nickel matt / satiné / satinado		

Möbelfuß BD-03, höhenverstellbar  
 Pied BD-03  
 Pata BD-03 ajustable

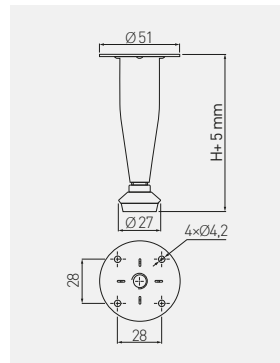





NM-BD-003-01	100 + 5	Chrom / chrome / cromado	Stahl / acier / acero	100
NM-BD-003-02		Nickel matt / satiné / satinado		

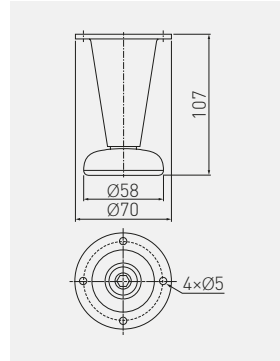







Möbelfuß BD-780  
Pied BD-780  
Pata BD-780

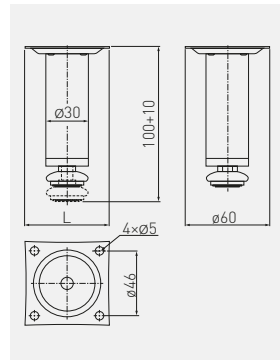

		 H mm			
NM-BD-780-M1		107	Chrom / chrome / cromado	Stahl / acier / acero	50
NM-BD-780-M2	Nickel matt / satiné / satinado				
NM-BD-780-M5	Aluminium / aluminium / aluminio				





Möbelfuß BD-100, höhenverstellbar  
Pied réglable BD-100  
Pata BD-100 ajustable

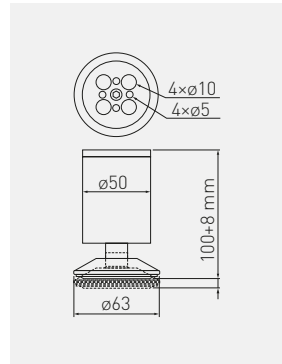

		 H mm			
NM-BD-100-01		100 + 10	Chrom / chrome / cromado	Stahl, acier, acero,	100
NM-BD-100-02	Nickel matt / satiné / satinado				
NM-BD-100-05	Aluminium / aluminium / aluminio				
NM-BD-100-06	Edelstahloptik / acier brossé / acero pulido				

Möbelfuß BD-762, höhenverstellbar  
 Pied réglable BD-762  
 Pata BD-762 ajustable



	 H mm			
NM-BD-762-01	100 + 8	Chrom / chrome / cromado	ZnAl + Stahl ZnAl + acier ZnAl + acero	50
NM-BD-762-05		Aluminium / aluminium / aluminio		

Möbelfuß BD-867  
 Pied BD-867  
 Pata BD-867

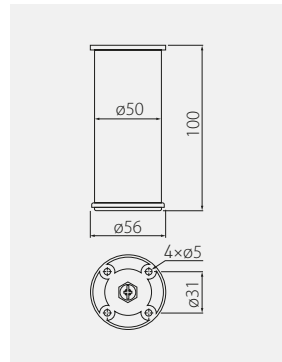

	 H mm			
NM-BD867-100	100	Aluminium / aluminium / aluminio	Aluminium / aluminium / aluminio	50

Möbelfuß BD-868  
 Pied BD-868  
 Pata BD-868

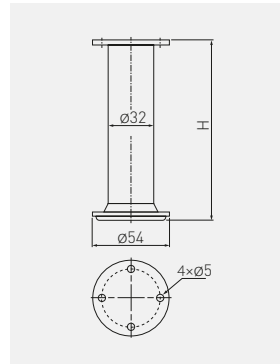

NM-BD868-100	100	Aluminium / aluminium / aluminio	Aluminium / aluminium / aluminio	50
NM-BD868-150	150			



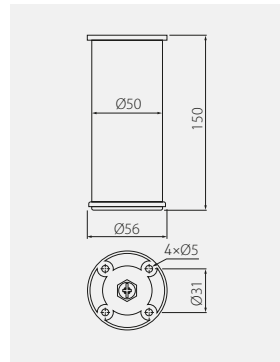

Möbelfuß BD-869  
 Pied BD-869  
 Pata BD-869

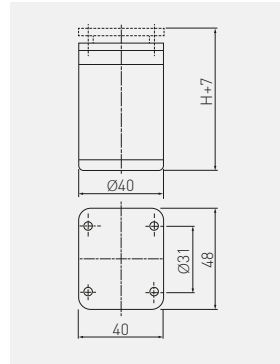

NM-BD869-150	150	Aluminium / aluminium / aluminio	Aluminium / aluminium / aluminio	50
--------------	-----	----------------------------------	----------------------------------	----



Möbelfuß DAP-77, höhenverstellbar  
 Pied réglable DAP-77  
 Pata DAP-77 regulable



	 H mm			
NM-DAP77-60	60 + 7	Aluminium / aluminium / aluminio	Aluminium + Kunststoff, aluminium + plastique, aluminio + plástico	100
NM-DAP77-100	100 + 7			
NM-DAP77-150	150 + 7			

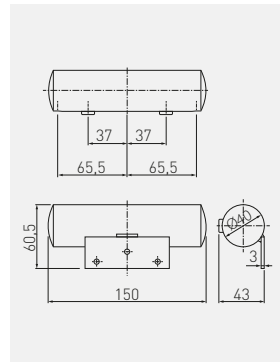



Möbelfuß BAHIA  
 Pied BAHIA  
 Pata BAHIA

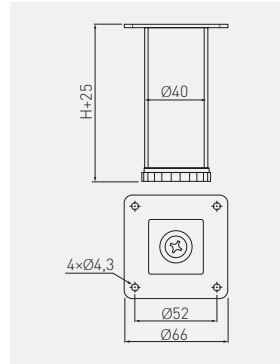

	 H mm			
NM-BAHIA40-150-01	43	Chrom / chrome / cromado	Stahl + Kunststoff, acier + plastique, acero + plástico,	50





Möbelfuß SQ-40, höhenverstellbar  
 Pied réglable SQ-40  
 Pata SQ-40 regulable

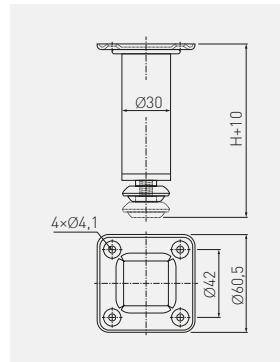

	 H mm			
NM-SQ40ADJ-060	60 + 25	Chrom / chrome / cromado	Stahl / acier / acero	100
NM-SQ40ADJ-100	100 + 25	Chrom / chrome / cromado		50

Möbelfuß SQA, höhenverstellbar  
 Pied réglable SQA  
 Pata SQA ajustable



	 H mm			
NM-SQA100-01	100 + 10	Chrom / chrome / cromado	Stahl / acier / acero	100
NM-SQA150-01*	150 + 10			

\*Produkt erhältlich auf individuelle Bestellung / Produit disponible sur demande / Producto disponible bajo demanda

Möbelfuß BD-727  
 Pied BD-727  
 Pata BD-727

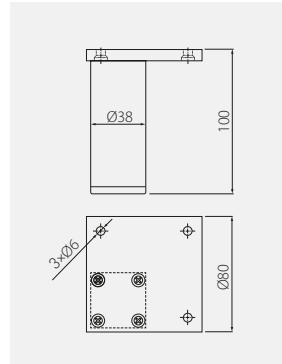

NM-BD727-100

100

Aluminium / aluminium / aluminio

Aluminium / aluminium / aluminio

50

Möbelfuß BD-739  
 Pied BD-739  
 Pata BD-739

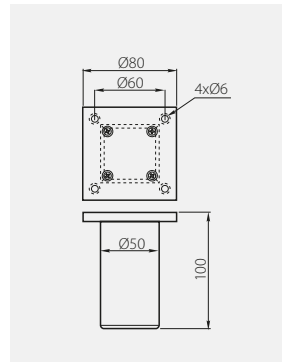

NM-BD-739-05

100





Aluminium / aluminium / aluminio

Aluminium / aluminium / aluminio

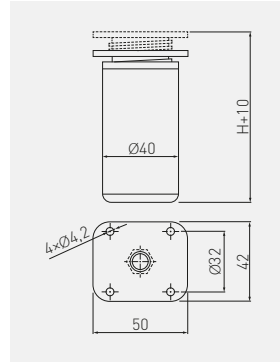
50





Möbelfuß DAK-27, höhenverstellbar  
 Pied réglable DAK-27  
 Pata DAK-27 regulable

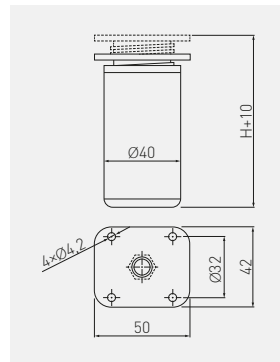

	 H mm			
NM-DAK27-060	60 + 10	Aluminium, aluminium, aluminio	Aluminium + Kunststoff, aluminium + plastique, aluminio + plástico	100
NM-DAK27-080	80 + 10			
NM-DAK27-100	100 + 10			
NM-DAK27-120	120 + 10			
NM-DAK27-150	150 + 10			

Möbelfuß NACK, höhenverstellbar  
 Pied NACK réglable  
 Pata NACK regulable



	 H mm			
NM-NACK27651-06	60 + 10	Chrom / chrome / cromado	Aluminium + Kunststoff, aluminium + plastique, aluminio + plástico	100

Möbelfuß BD-01  
 Pied BD-01  
 Pata BD-01

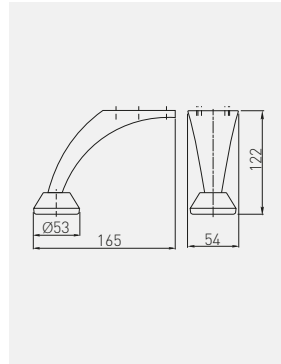

NM-BD-001-M1B	122	Chrom / chrome / cromado	Stahl / acier / acero	80
---------------	-----	--------------------------	-----------------------	----

Möbelfuß BD-712  
 Pied BD-712  
 Pata BD-712

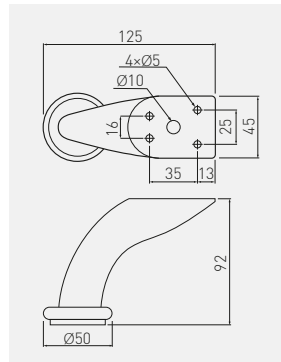





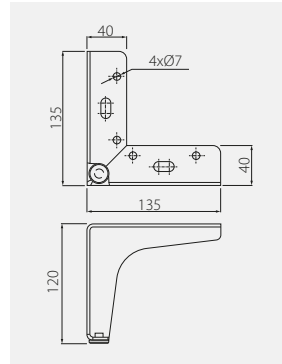

NM-BD-712-M1	92	Chrom / chrome / cromado	Stahl / acier / acero	50
--------------	----	--------------------------	-----------------------	----

\*Produkt erhältlich auf individuelle Bestellung / Produit disponible sur demande / Producto disponible bajo demanda



Möbelfuß STGY 135  
Pied STGY 135  
Pata STGY 135



		 H mm			
NM-STGY135-100-01		100	Chrom / chrome / cromado	Stahl + Kunststoff, acier + plastique, acero + plástico,	50
NM-STGY135-130-01*		130			
NM-STGY135-150-01*		150			

\*Produkt erhältlich auf individuelle Bestellung / Produit disponible sur demande / Producto disponible bajo demanda

Möbelfuß STOMP  
Pied STOMP  
Pata STOMP

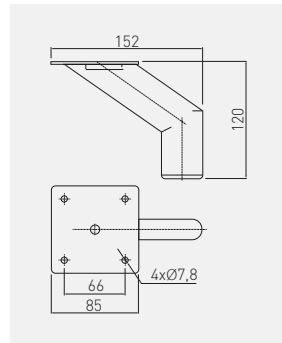

		 H mm			
NM-STOMP-100-01*		100	Chrom / chrome / cromado	Stahl, acier, acero,	100
NM-STOMP-120-10*		120	weiß / blanc / blanco		
NM-STOMP-120-20			schwarz / noir / negro		
NM-STOMP-130-01*		130	Chrom / chrome / cromado		
NM-STOMP-130-06*			Edelstahloptik / acier brossé / acero pulido		
NM-STOMP-130-20*			schwarz / noir / negro		
NM-STOMP-150-01*		150	Chrom / chrome / cromado		60
NM-STOMP-160-01*		160	Chrom / chrome / cromado		
NM-STOMP-160-06*			Edelstahloptik / acier brossé / acero pulido		
NM-STOMP-160-20*			schwarz / noir / negro		

\*Produkt erhältlich auf individuelle Bestellung / Produit disponible sur demande / Producto disponible bajo demanda

Tischbein NM-RONDA  
Pied NM-RONDA  
Pata NM-RONDA

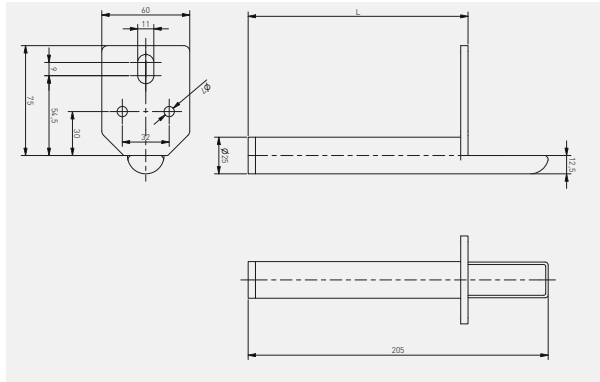

NM-RONDA-150-18	150	Gold / or / oro	Stahl + Kunststoff, acier + plastique, acero + plástico,
NM-RONDA-150-20M		schwarz matt / noir mat / negro mate	
NM-RONDA-180-18	180	Gold / or / oro	
NM-RONDA-180-20M		schwarz matt / noir mat / negro mate	

Möbelfuß MDN-D4  
Pied MDN-D4  
Pata MDN-D4

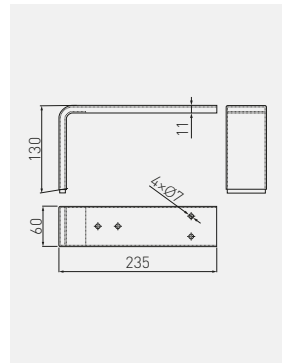

NM-MDN-D4-01	130	Chrom / chrome / cromado	Stahl / acier / acero	25
--------------	-----	--------------------------	-----------------------	----

Möbelfuß MDN-926  
 Pied MDN-926  
 Pata MDN-926

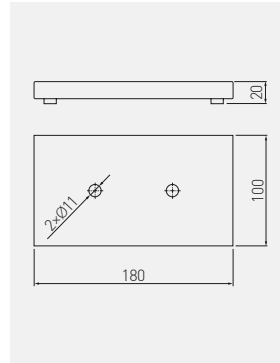

NM-MDN926-01



20



Chrom / chrome / cromado



Stahl / acier / acero



50

Möbelfuß MDN-927  
 Pied MDN-927  
 Pata MDN-927

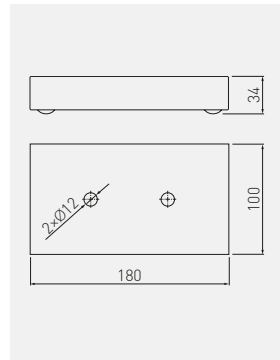

NM-MDN927-01



34



Chrom / chrome / cromado



Stahl / acier / acero



50

Möbelfuß MDN-941  
 Pied MDN-941  
 Pata MDN-941

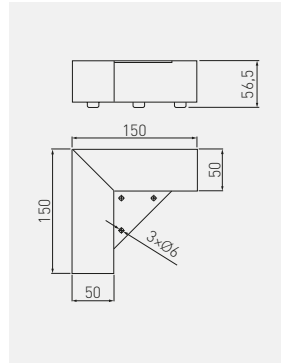

NM-MDN941-01



56



Chrom / chrome / cromado



Stahl / acier / acero



25

Gleiter WPJ, höhenverstellbar  
 Glissière WPJ réglable  
 Pata WPJ ajustable

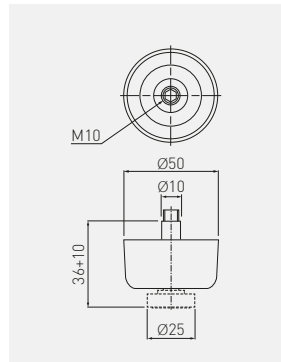

NM-WPJ22-D20



36 + 10



schwarz / noir / negro



Kunststoff / plastique / plástico



5

Gleiter SLZ, einzeln  
 Glissière SLZ unique  
 Pata atornillable SLZ simple

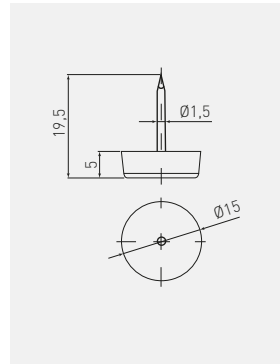

BP-SLZIGW-10



schwarz / noir / negro



Kunststoff / plastique / plástico

Gleiter SLZ, doppelt  
 Glissière SLZ double tête  
 Pata atornillable SLZ doble

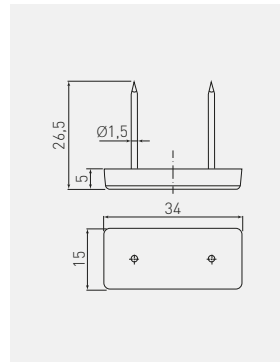

BP-SLZIGW-21



schwarz / noir / negro



Kunststoff / plastique / plástico



250

Stellfuß M6, rund, verstellbar  
 Pied réglable M6  
 Pata M6 regulable

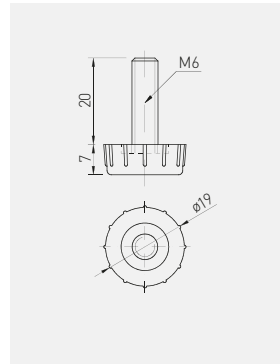

NM-STOPKA-M6



verzinkt  
galvanisé  
galvanizado



Stahl + Kunststoff,  
acier + plastique,  
acero + plástico,

Stellfuß M6, sechskantig, verstellbar  
 Pied de lit hexagonal réglable M6  
 Pata M6 regulable hexagonal

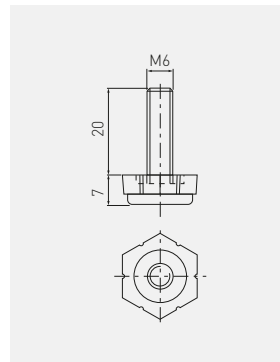

NM-STOPKSZESTK-M6



verzinkt  
galvanisé  
galvanizado



Stahl + Kunststoff,  
acier + plastique,  
acero + plástico,



250

Muffe M6  
Mufa M6  
Tornillo M6



NM-MUFAWB-00



NM-MUFAWK-00

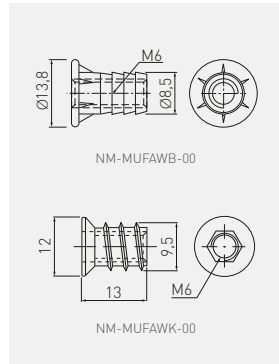

NM-MUFAWB-00	zum Einschlagen frappé clavada	silberfarben, argent, plata	ZnAl	2500
NM-MUFAWK-00	zum Einschrauben vissé atornillada			4000

Stellfuß DPD, höhenverstellbar  
Pied DPD réglable  
Pata DPD regulable

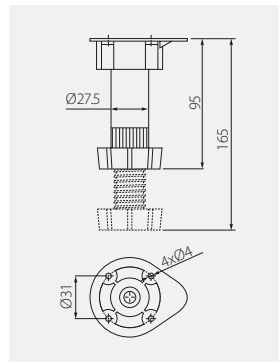

NM-DPD20-100	95 - 165 mm	60 kg	schwarz / noir / negro	Kunststoff / plastique / plástico	200

Clip für Stellfuß DPD  
Clips pour pied DPD  
Clip para pata DPD

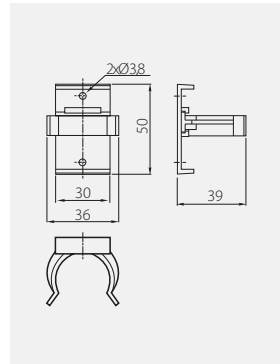

NM-KL-DPL-20



schwarz / noir / negro



Kunststoff / plastique / plástico



1500

Stellfuß DPA, höhenverstellbar  
Pied DPA  
Pata DPA

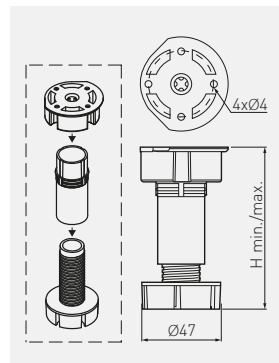

NM-DPA20-100



im Beutel verpackt  
emballage sac plastique  
presentado en bolsa



87 - 120



100



schwarz,  
noir,  
negro



Kunststoff,  
plastique,  
plástico



250

NM-DPA20-150

im Beutel verpackt  
emballage sac plastique  
presentado en bolsa

137 - 170

NM-DPA20-100W

im Beutel verpackt  
emballage sac plastique  
presentado en bolsa

87 - 120

NM-DPA20-150W

im Beutel verpackt  
emballage sac plastique  
presentado en bolsa

137 - 170

200

100

400



Clip für Stellfuß DPA  
Clips pour pied DPA  
Clip para pata DPA

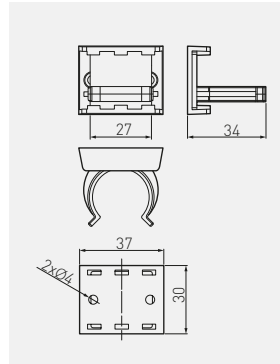

NM-KL-DPA-20



schwarz / noir / negro



Kunststoff / plastique / plástico

Stellfuß MLA-50, höhenverstellbar  
Pied réglable MLA-50  
Pata MLA-50 regulable

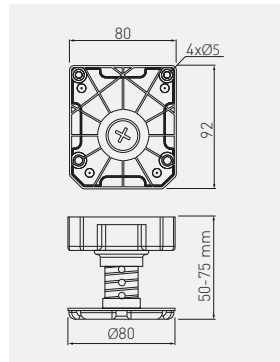

NM-MLA-50-75



50-75  
mm



450  
kg



schwarz / noir / negro



Kunststoff / plastique / plástico



50

Stellfuß MLA-65, höhenverstellbar  
 Pied réglable MLA-65  
 Pata MLA-65 regulable

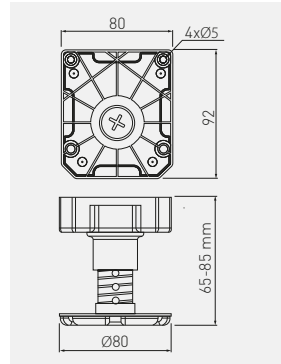

	 H mm	 kg t			
NM-MLA-65-85	65 – 85	450	schwarz / noir / negro	Kunststoff / plastique / plástico	50

Stellfuß MLA-85, höhenverstellbar  
 Pied réglable MLA-85  
 Pata MLA-85 regulable

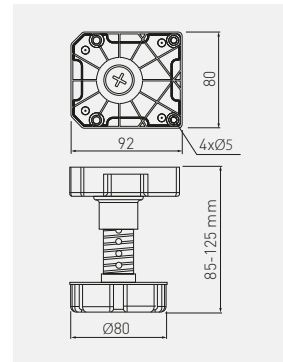

	 H mm	 kg t			
NM-MLA-85-125	85 – 125	450	schwarz / noir / negro	Kunststoff / plastique / plástico	50



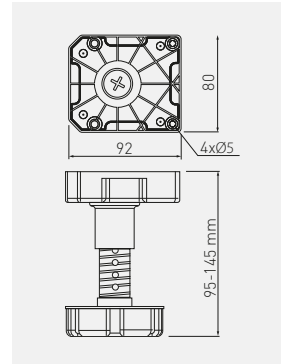



Stellfuß MLA-95, höhenverstellbar  
 Pied réglable MLA-95  
 Pata MLA-95 regulable

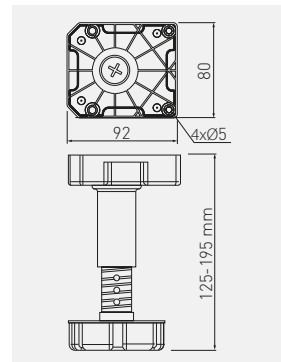

	 H mm	 kg			
NM-MLA-95-145	95 - 145	450	schwarz / noir / negro	Kunststoff / plastique / plástico	100

Stellfuß MLA-125, höhenverstellbar  
 Pied réglable MLA-125  
 Pata MLA-125 regulable



	 H mm	 kg			
NM-MLA-125-195	125 - 195	450	schwarz / noir / negro	Kunststoff / plastique / plástico	50

Clip für Stellfuß MLA  
 Clip pour pied MLA  
 Clip para pata MLA

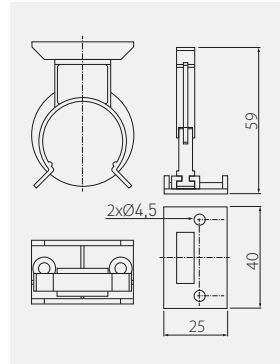

NM-MLA-KL



schwarz / noir / negro



Kunststoff / plastique / plástico



100



Tischbein A6, höhenverstellbar  
Pied réglable A6  
Pata A6 regulable

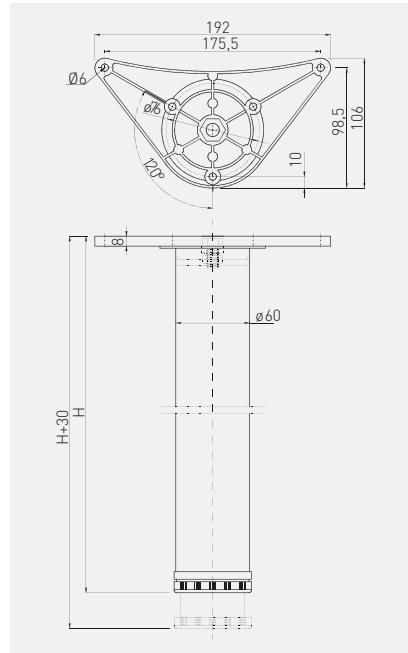

NM-A60710-01	710 + 30	Chrom / chrome / cromado	ZnAl + Stahl ZnAl + acier ZnAl + acero	4
NM-A60710-02		Nickel matt / satiné / satinado		
NM-A60710-05		Aluminium / aluminium / aluminio		
NM-A60710-06*		Edelstahloptik / acier brossé / acero pulido		
NM-A60710-10N*		weiß / blanc / blanco		
NM-A60710-20		schwarz / noir / negro		
NM-A60710-80N	silberfarben / argent / plata			
NM-A60820-01	820 + 30	Chrom / chrome / cromado		
NM-A60820-02		Nickel matt / satiné / satinado		
NM-A60820-05		Aluminium / aluminium / aluminio		
NM-A60820-06*		Edelstahloptik / acier brossé / acero pulido		
NM-A60820-10N*		weiß / blanc / blanco		
NM-A60820-20*		schwarz / noir / negro		
NM-A60820-80N*	silberfarben / argent / plata			
NM-A60870-01*	870 + 30	Chrom / chrome / cromado		
NM-A60870-02*		Nickel matt / satiné / satinado		
NM-A60870-05*		Aluminium / aluminium / aluminio		
NM-A60870-06*		Edelstahloptik / acier brossé / acero pulido		
NM-A60870-10N*		weiß / blanc / blanco		
NM-A60870-20*		schwarz / noir / negro		
NM-A60870-80N*	silberfarben / argent / plata			
NM-A61100-01	1100 + 30	Chrom / chrome / cromado		
NM-A61100-02		Nickel matt / satiné / satinado		
NM-A61100-05		Aluminium / aluminium / aluminio		
NM-A61100-06		Edelstahloptik / acier brossé / acero pulido		
NM-A61100-10N*		weiß / blanc / blanco		
NM-A61100-20*		schwarz / noir / negro		

Tischbein NM-A80, höhenverstellbar  
 Pied réglable NM-A80  
 Pata NM-A80 regulable

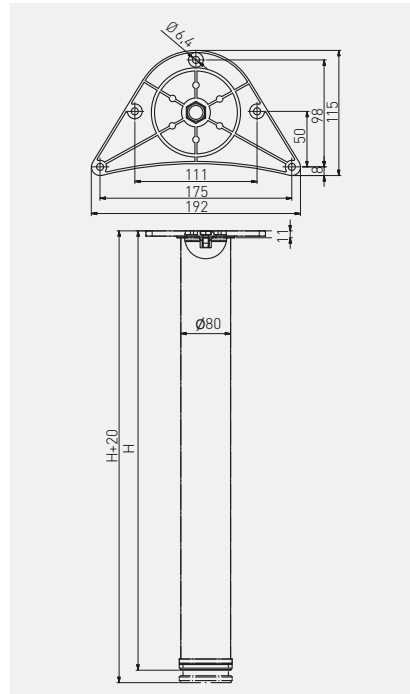







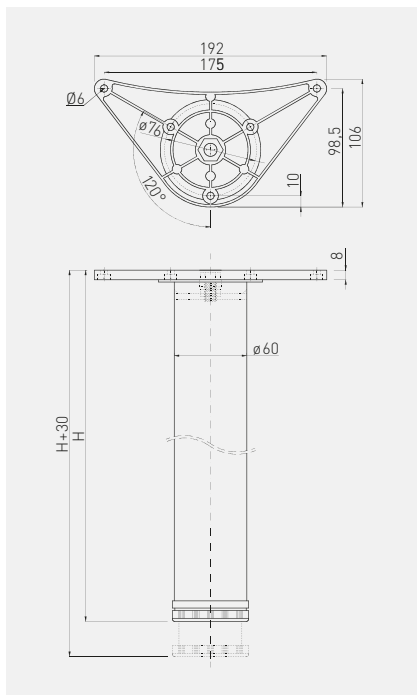



NM-A80710-01*	710 + 20	Chrom / chrome / cromado	ZnAl + Stahl ZnAl + acier ZnAl + acero	2
NM-A80710-02*		Nickel matt / satiné / satinado		
NM-A80710-03*		zlato / zlato / arany / aur		
NM-A80710-05*		Aluminium / aluminium / aluminio		
NM-A80710-06*		Edelstahloptik / acier brossé / acero pulido		
NM-A80710-10*		weiß / blanc / blanco		
NM-A80710-20*		schwarz / noir / negro		
NM-A80710-80*		silberfarben / argent / plata		
NM-A80870-01*	870 + 20	Chrom / chrome / cromado		
NM-A80870-02*		Nickel matt / satiné / satinado		
NM-A80870-03*		zlato / zlato / arany / aur		
NM-A80870-05*		Aluminium / aluminium / aluminio		
NM-A80870-06*		Edelstahloptik / acier brossé / acero pulido		
NM-A80870-10*		weiß / blanc / blanco		
NM-A80870-20*		schwarz / noir / negro		
NM-A80870-80*		silberfarben / argent / plata		

\*Produkt erhältlich auf individuelle Bestellung / Produit disponible sur demande / Producto disponible bajo demanda

Tischbein G6, höhenverstellbar  
 Pied réglable G6  
 Pata G6 regulable









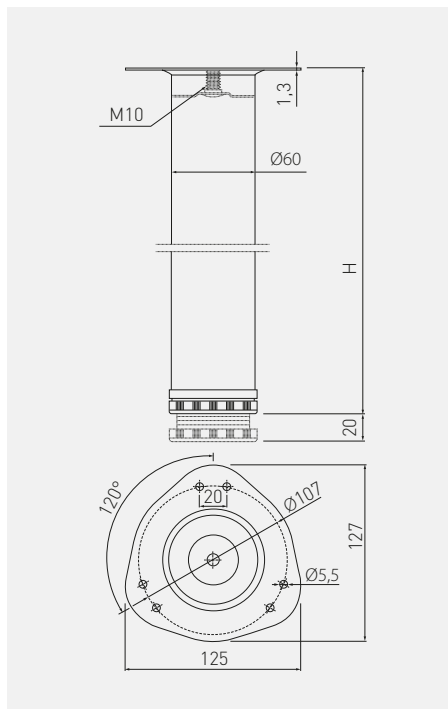

		 H mm							
NM-G60710-01N	710 + 30		Chrom / chrome / cromado						
NM-G60710-02N			Nickel matt / satiné / satinado						
NM-G60710-05N			Aluminium / aluminium / aluminio						
NM-G60710-06N			Edelstahloptik / acier brossé / acero pulido						
NM-G60710-10N*			weiß / blanc / blanco						
NM-G60710-20N			schwarz / noir / negro						
NM-G60710-80N			silberfarben / argent / plata						
NM-G60820-01N	820 + 30		Chrom / chrome / cromado						
NM-G60820-05N			Aluminium / aluminium / aluminio						
NM-G60820-06N			Edelstahloptik / acier brossé / acero pulido						
NM-G60820-10N*			weiß / blanc / blanco						
NM-G60820-20N			schwarz / noir / negro						
NM-G61100-01N	1100 + 30		Chrom / chrome / cromado						
NM-G61100-20N			schwarz / noir / negro						

\*Auf Anfrage in weißer Farbe erhältlich / Blanc disponible sur demande / Color blanco disponible bajo demanda

Tischbein S6, höhenverstellbar  
 Pied réglable S6  
 Pata S6 regulable



		 H mm					
NM-S60710-01A	710 + 20		Chrom / chrome / cromado				
NM-S60710-02A			Nickel matt / satiné / satinado				
NM-S60710-05A			Aluminium / aluminium / aluminio				
NM-S60710-06A			Edelstahloptik / acier brossé / acero pulido				
NM-S60710-10A*			weiß / blanc / blanco				
NM-S60710-20A			schwarz / noir / negro				
NM-S60820-01A	820 + 20		Chrom / chrome / cromado				
NM-S60820-02A*			Nickel matt / satiné / satinado				
NM-S60820-05A			Aluminium / aluminium / aluminio				
NM-S60820-06A*			Edelstahloptik / acier brossé / acero pulido				
NM-S60820-10A*			weiß / blanc / blanco				
NM-S60820-20A*			schwarz / noir / negro				

\*Produkt erhältlich auf individuelle Bestellung / Produit disponible sur demande / Producto disponible bajo demanda



Tischbein F-50, klappbar  
 Pied F-50 pliable  
 Pata F-50 plegable

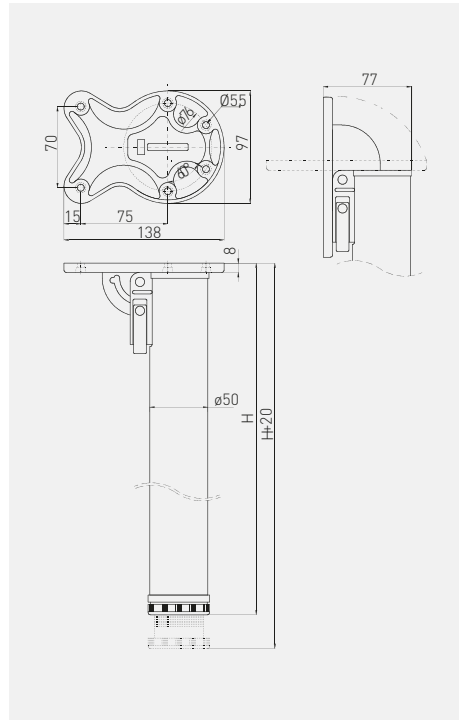

		 H mm			
NM-F50710-01		710 + 20	Chrom / chrome / cromado		
NM-F50710-06			Edelstahloptik / acier brossé / acero pulido		
NM-F50710-10			weiß / blanc / blanco		
NM-F50710-20			schwarz / noir / negro		
NM-F50870-01		870 + 20	Chrom / chrome / cromado		
NM-F50870-06			Edelstahloptik / acier brossé / acero pulido		
NM-F50870-10*			weiß / blanc / blanco		
NM-F50870-20			schwarz / noir / negro		

ZnAl + Stahl + ABS  
 ZnAl + acier + ABS  
 ZnAl + acero + ABS

8

\*Produkt erhältlich auf individuelle Bestellung / Produit disponible sur demande / Producto disponible bajo demanda

X-LINE schräges Bein  
 Pied oblique X-LINE  
 Pata oblicua X-LINE

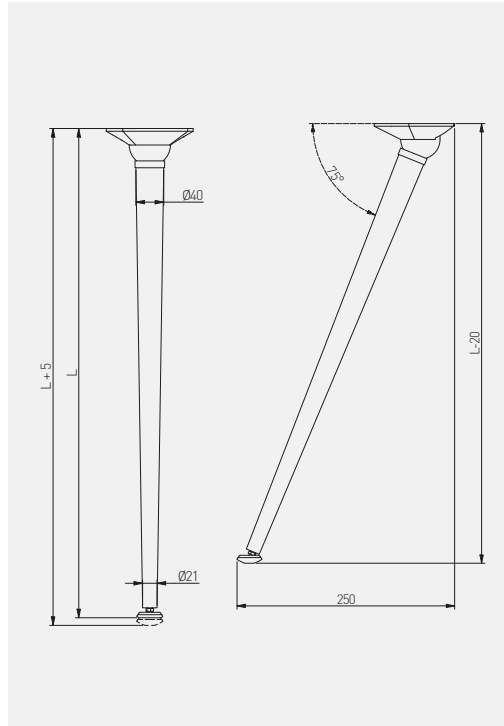

		 mm			
NM-X-LINE40710-01	710	Chrom / chrome / cromado		Stahl + Kunststoff, acier + plastique, acero + plástico,	4
NM-X-LINE40710-20		schwarz / noir / negro			
NM-X-LINE40710-10		weiß / blanc / blanco			





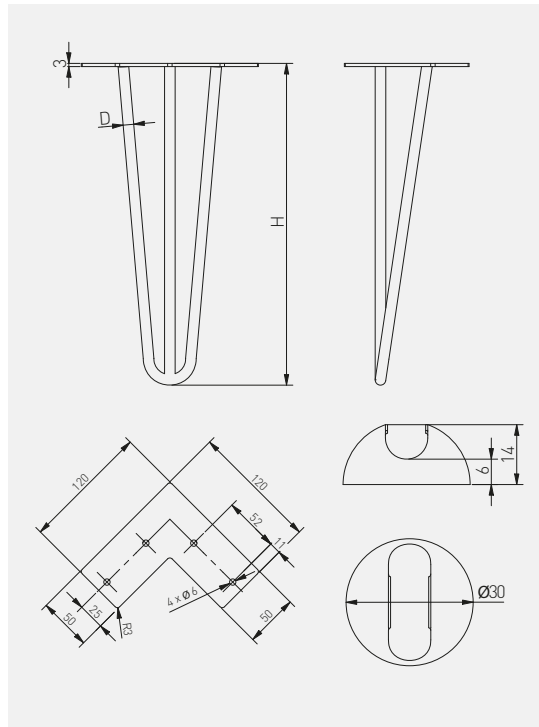



ARTO Bein – hairpin  
 Pied ARTO – hairpin  
 Pata ARTO – hairpin

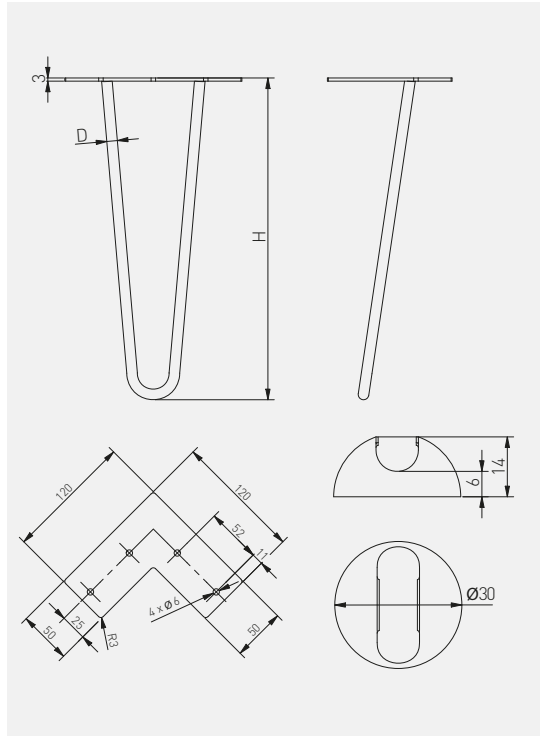

	 H mm	$\varnothing$ D (mm)			
NM-ARTO-10-3R304-20M	304	ø10	schwarz matt, noir mat, negro mate	Stahl + Kunststoff, acier + plastique, acero + plástico,	4
NM-ARTO-10-3R406-20M	406				
NM-ARTO-10-3R711-20M	711				
NM-ARTO-12-3R304-20M	304	ø12			
NM-ARTO-12-3R406-20M	406				
NM-ARTO-12-3R711-20M	711				

ARTO Bein – hairpin  
 Pied ARTO – hairpin  
 Pata ARTO – hairpin



	 H mm	$\varnothing$ D (mm)			
NM-ARTO-10-2R304-20M	304	ø10	schwarz matt, noir mat, negro mate	Stahl + Kunststoff, acier + plastique, acero + plástico,	4
NM-ARTO-10-2R406-20M	406				
NM-ARTO-10-2R711-20M	711				
NM-ARTO-12-2R304-20M	304	ø12			
NM-ARTO-12-2R406-20M	406				
NM-ARTO-12-2R711-20M	711				

Industrie Tischgestell  
 Pied de table industriel Industria  
 Estructura para tableros de mesa Industria



NEW

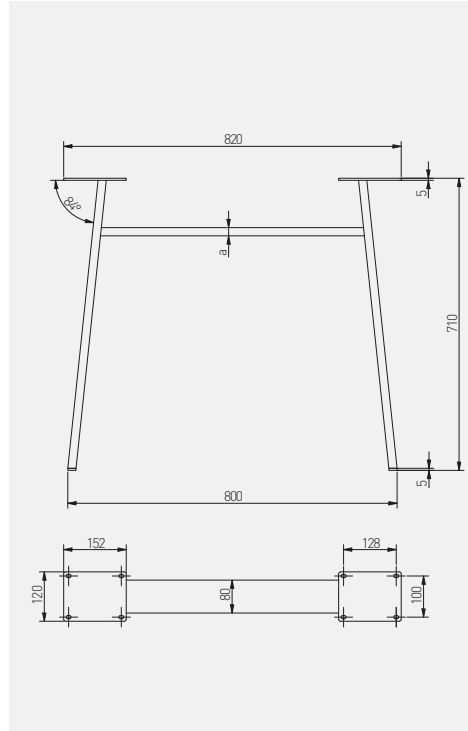

		<b>a</b> (mm)		
NM-INDUSTRIA-H20-710X820-20M*	schwarz matt, noir mat, negro mate	20	Stahl, acier, acero,	1
NM-INDUSTRIA-H40-710X820-20M*		40		



\*Produkt erhältlich auf individuelle Bestellung / Produit disponible sur demande / Producto disponible bajo demanda

Industrie Tischgestell  
 Pied de table industriel Industria  
 Estructura para tableros de mesa Industria

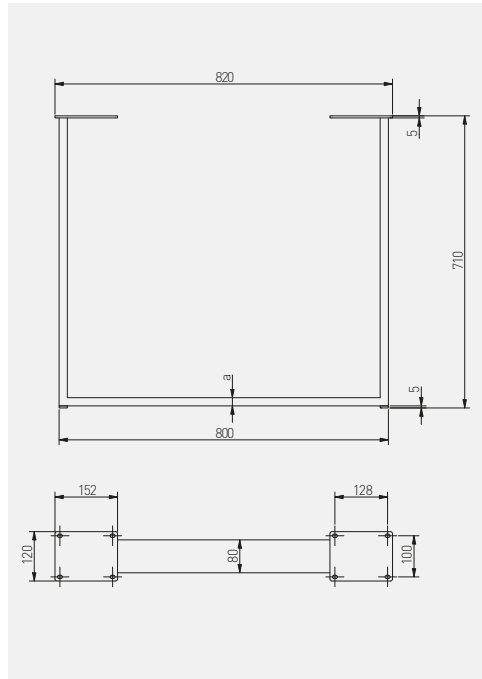

NEW





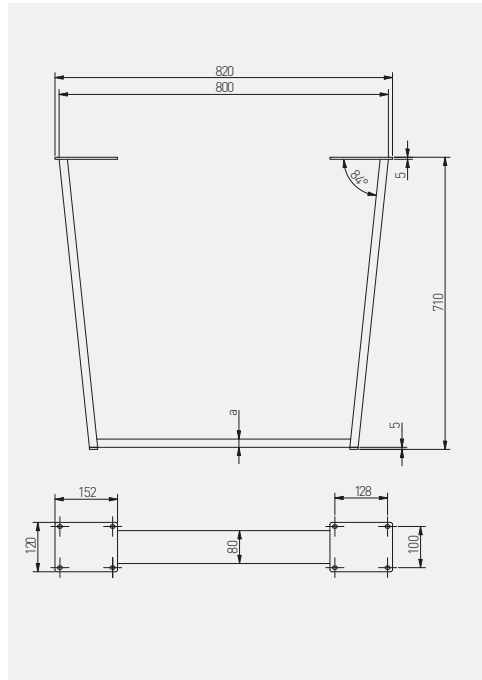

			<b>a</b> (mm)		
NM-INDUSTRIA-P20-710X820-20M*			20	Stahl, acier, acero,	1
NM-INDUSTRIA-P40-710X820-20M*		schwarz matt / noir mat / negro mate	40		
NM-INDUSTRIA-P80-710X820-20M*			80		

\*Produkt erhältlich auf individuelle Bestellung / Produit disponible sur demande / Producto disponible bajo demanda

Industrie Tischgestell  
 Pied de table industriel Industria  
 Estructura para tableros de mesa Industria



		<b>a</b> (mm)		
NM-INDUSTRIA-T20-710X820-20M*	schwarz matt / noir mat / negro mate	20	Stahl, acier, acero,	1
NM-INDUSTRIA-T40-710X820-20M*		40		

\*Produkt erhältlich auf individuelle Bestellung / Produit disponible sur demande / Producto disponible bajo demanda



Industrie Tischgestell  
 Pied de table industriel Industria  
 Estructura para tableros de mesa Industria

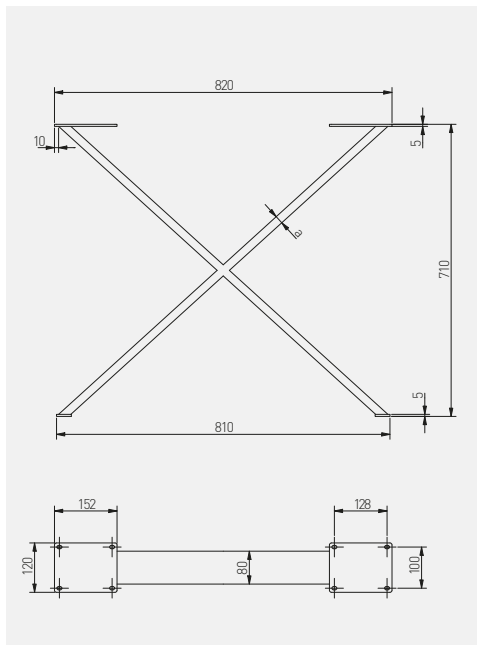

		a (mm)		
NM-INDUSTRIA-X20-710X820-20M*	schwarz matt / noir mat / negro mate	20	Stahl, acier, acero,	1
NM-INDUSTRIA-X40-710X820-20M*		40		
NM-INDUSTRIA-X80-710X820-20M*		80		

\*Produkt erhältlich auf individuelle Bestellung / Produit disponible sur demande / Producto disponible bajo demanda

Tischbein mit quadratischem Querschnitt, höhenverstellbar  
 Pied carré réglable  
 Pata cuadrada extensible

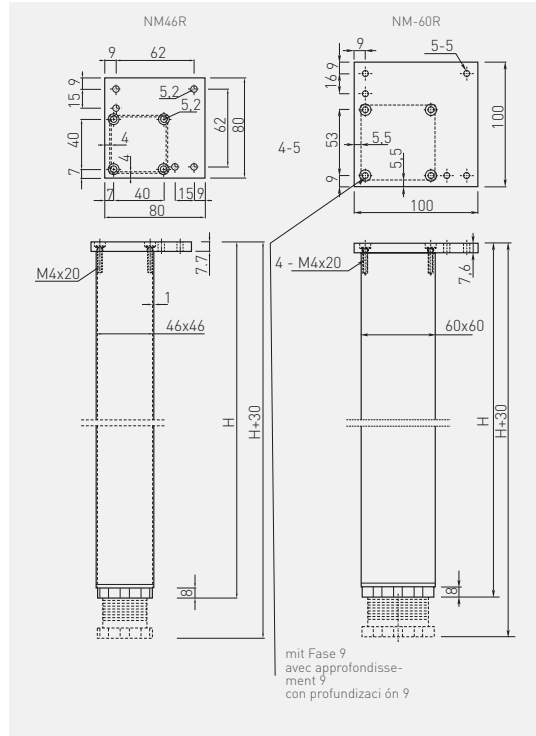
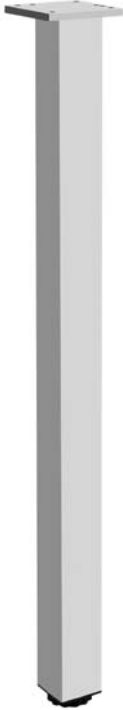



NM-46R710-05	710 + 30	Aluminium / aluminium / aluminio	Aluminium, aluminium, aluminio	4	
NM-46R820-05	820 + 30				
NM-60R710-05	710 + 30				
NM-60R820-05	820 + 30				
NM-60R710-06	710 + 30				Edelstahloptik / acier brossé / acero pulido
NM-60R710-20					schwarz / noir / negro

Schreibtischgestell  
Support de bureau  
Base para escritorio

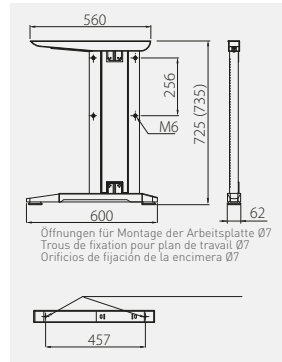
NEW



	 mm			
SB-A60x72-80	725 (735)	silberfarben / argent / plata	Stahl, acier, acero,	1
SB-A60x72-20M		schwarz matt / noir mat / negro mate		1





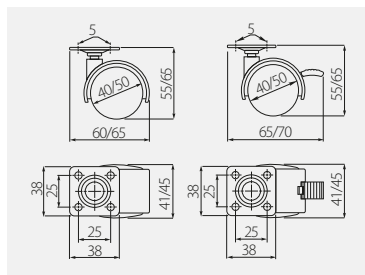



Möbelrolle KM-D20  
Roulettes KM-D20  
Rueda KM-D20

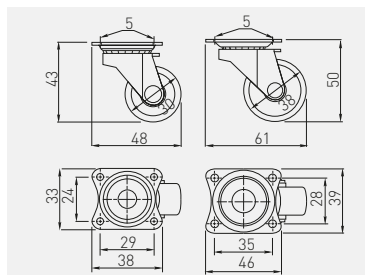

		 mm	 kg		
KM-00-40-D20	ohne Feststeller sans frein sin freno	40	18	schwarz, noir, negro	Stahl + Kunststoff, acier + plastique, acero + plástico,
KM-00-50-D20		50	22		
KM-0H-40-D20	mit Feststeller avec frein con freno	40	18		
KM-0H-50-D20		50	22		

Möbelrolle KM 15, Kunststoff  
Roulettes en plastique KM 15  
Rueda KM 15 de plástico



	 mm	 kg		
KM-015030-10	30	13,5	weiß / blanc / blanco	Stahl + Kunststoff, acier + plastique, acero + plástico,
KM-015030-20	30		schwarz / noir / negro	
KM-015038-10	38	16	weiß / blanc / blanco	

Möbelrolle KM 15, Gummi  
Roulettes en caoutchouc KM15  
Rueda KM 15 de goma

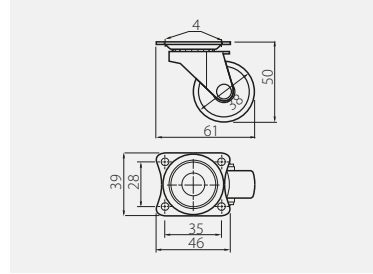

KM-015038-GM	38	16	schwarz / noir / negro	Gummi + Stahl rubber + acier goma + acero



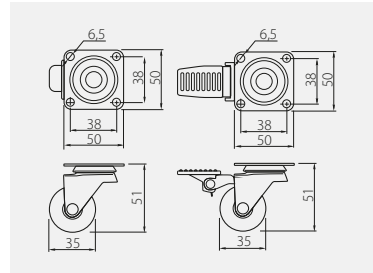

Möbelrolle KMA 35  
Roulettes KMA 35  
Rueda KMA 35

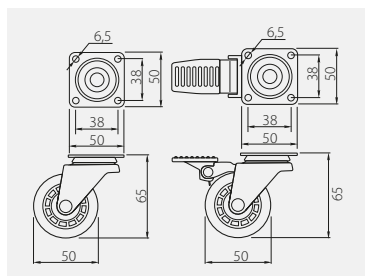

KM-A035MM-00	ohne Feststeller sans frein sin freno	35	25	transparent / transparent / transparente	PC / PU
KM-A035MM-30				braun / bronze / marrón	
KM-AH35MM-00	mit Feststeller avec frein con freno			transparent / transparent / transparente	
KM-AH35MM-30				braun / bronze / marrón	





Möbelrolle KMA 50  
Roulettes KMA 50  
Rueda KMA 50

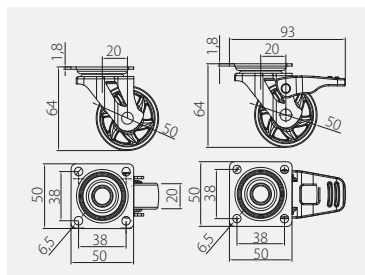

					
KM-A050MM-00	ohne Feststeller sans frein sin freno	50	35	transparent / transparent / transparente	PC / PU
KM-A050MM-30				braun / bronze / marrón	
KM-AH50MM-00	mit Feststeller avec frein con freno			transparent / transparent / transparente	
KM-AH50MM-30				braun / bronze / marrón	

Möbelrolle SHIFT 50  
Roulettes SHIFT 50  
Rueda SHIFT 50



					
KM-B050MM-00	ohne Feststeller sans frein sin freno	50	30	transparent / transparent / transparente	PC / PU
KM-B050MM-30				braun / bronze / marrón	
KM-BH50MM-00	mit Feststeller avec frein con freno			transparent / transparent / transparente	
KM-BH50MM-30				braun / bronze / marrón	

Möbelrolle SHIFT 75  
Roulettes SHIFT 75  
Rueda SHIFT 75

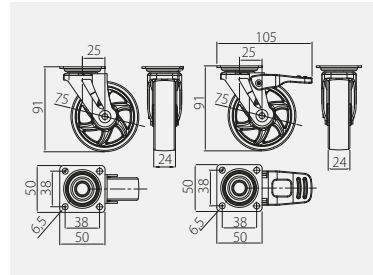

KM-B075MM-00	ohne Feststeller sans frein sin freno	75	40	transparent / transparent / transparente	PC / PU
KM-B075MM-30				braun / bronze / marrón	
KM-BH75MM-00	mit Feststeller avec frein con freno			transparent / transparent / transparente	
KM-BH75MM-30				braun / bronze / marrón	



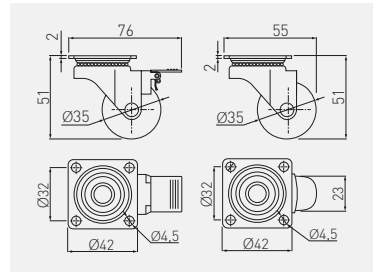

Möbelrolle BRAZYLIA 35  
Roulettes BRAZYLIA 35  
Rueda BRAZYLIA 35

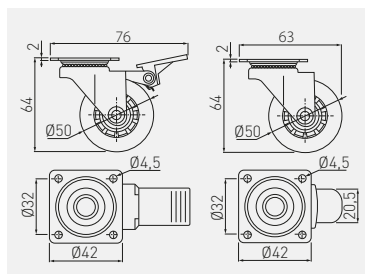

KM-RD-35-SF	ohne Feststeller sans frein sin freno	35	30	transparent / transparent / transparente	PC, PU
KM-RD-35-SF-20				schwarz / noir / negro	
KM-RD-35-CF	mit Feststeller avec frein con freno			transparent / transparent / transparente	
KM-RD-35-CF-20				schwarz / noir / negro	





Möbelrolle BRAZYLIA 50  
Roulettes BRAZYLIA 50  
Rueda BRAZYLIA 50

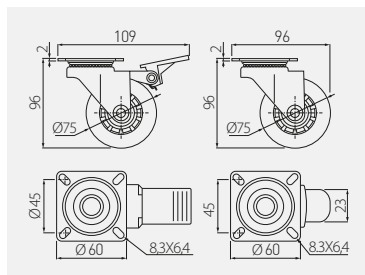

					
KM-RD-50-SF	ohne Feststeller sans frein sin freno	50	40	transparent / transparent / transparente	PC, PU
KM-RD-50-SF-20				schwarz / noir / negro	
KM-RD-50-CF	mit Feststeller avec frein con freno			transparent / transparent / transparente	
KM-RD-50-CF-20				schwarz / noir / negro	

Möbelrolle BRAZYLIA 75  
Roulettes BRAZYLIA 75  
Rueda BRAZYLIA 75







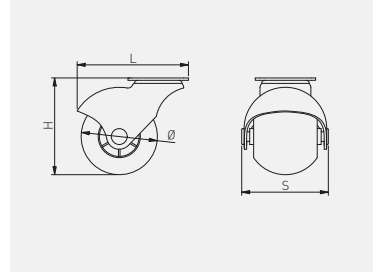

					
KM-RD-75-SF	ohne Feststeller sans frein sin freno	75	64	transparent / transparent / transparente	PC, PU
KM-RD-75-SF-20				schwarz / noir / negro	
KM-RD-75-CF	mit Feststeller avec frein con freno			transparent / transparent / transparente	
KM-RD-75-CF-20				schwarz / noir / negro	









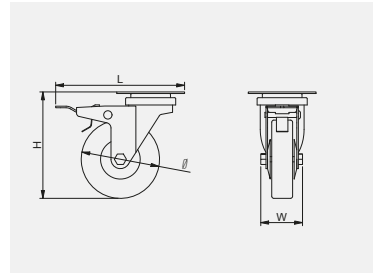

Möbelrolle SPAIN  
Roulettes SPAIN  
Rueda SPAIN



	 mm	 mm	 kg		
KM-SPAIN-40MM-18	40	53 x 62 x 47	15	grau, gris, gris	Gummi + Stahl rubber + acier goma + acero
KM-SPAIN-50MM-18	50	61 x 70 x 54	20		

Möbelrolle GREYROLL  
Roulettes GREYROLL  
Rueda GREYROLL



		 mm	 mm	 kg		
KM-GREYROLL-50mm-BH	ohne Feststeller sans frein sin freno	50	72 x 72 x 39	40	grau, gris, gris	Gummi + Stahl rubber + acier goma + acero
KM-GREYROLL-75mm-BH		75	98 x 104 x 42	55		
KM-GREYROLL-50mm-ZH	mit Feststeller avec frein con freno	50	94 x 72 x 39	40		
KM-GREYROLL-75mm-ZH		75	117 x 104 x 42	55		

**SCHIEBETÜRSYSTEME**  
**SYSTÈMES POUR PORTES COULISSANTES**  
**SISTEMAS DESLIZANTES**

Unteres Laufsystem

Châssis inférieur

Sistema de carril inferior

511 – 540

Oberes Laufsystem

Châssis supérieur

Sistema de carril superior

541 – 545





**LERNEN SIE DEN SCHRANK- UND SCHIEBETÜREN-  
-KONFIGURATOR GTV KENNEN**

**DÉCOUVREZ LE CONFIGURATEUR D'ARMOIRES  
ET DE PORTES COULISSANTES GTV**

**DESCUBRA EL CONFIGURADOR DE ARMARIOS  
Y PUERTAS CORREDERAS GTV**

Wenn Sie möchten, dass Ihre tägliche Arbeit beim Planen von Schränken leichter wird, haben wir die perfekte Lösung – den Schrank- und Schiebetüren-Konfigurator von GTV. Das ist ein einfaches und intuitives Tool, das die Arbeit jedes Tischlers effizienter und schneller macht. Den Konfigurator können auch Möbelgroßhändler, Firmen und Fabriken nutzen, die sich mit der Produktion von Schränken befassen. Der Schrank-Konfiguration von GTV bietet eine genaue Zusammenfassung in einer PDF-Datei mit technischen Informationen zum Schrank. Der endgültige Bericht erleichtert den Einkauf der nötigen Materialien.

Si vous souhaitez faciliter votre travail quotidien de conception d'armoires, nous avons une excellente solution : le configurateur d'armoires et de portes coulissantes GTV. C'est un outil facile et intuitif qui permet d'améliorer et d'accélérer le travail de tout charpentier. Le configurateur peut également être utilisé par les grossistes de meubles, les entreprises et les usines qui fabriquent des armoires. Le configurateur d'armoires GTV permet de recevoir un plan détaillé dans un fichier PDF avec des informations techniques sur l'armoire. Le résultat de planification facilite l'achat des matériaux nécessaires.

Si quieres facilitar tu trabajo diario de diseño de armarios, tenemos una gran solución: el configurador de armarios y puertas correderas GTV. Es una herramienta fácil e intuitiva que agilizará y acelerará el trabajo de todo ebanista. El configurador también puede ser utilizado por mayoristas de muebles, empresas y fabricantes de armarios. El configurador de armarios GTV te permite recibir un resumen detallado en un archivo PDF con información técnica sobre el armario. El informe final facilita la compra de los materiales necesarios.







Griffprofil ERGO  
Poignée ERGO  
Perfil ERGO

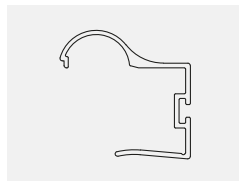

A-R18ERG-270-05	2700	Aluminium / aluminium / aluminio	Aluminium, aluminium, aluminio
A-R18ERG-270-90		Champagner / champagne / champán	
A-R18ERG-270-20M		schwarz matt / noir mat / negro mate	



Griffprofil ERGO 16  
Poignée ERGO 16  
Perfil ERGO 16

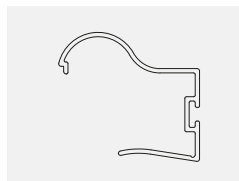

A-R16ERG-220-05	2200	Aluminium / aluminium / aluminio	Aluminium, aluminium, aluminio
A-R16ERG-230-50	2300	Aluminium / aluminium / aluminio	
A-R16ERG-270-50	2700	Aluminium / aluminium / aluminio	
A-R16ERG-270-90*	2700	Champagner / champagne / champán	



\*Bis die Bestände ausgehen / Jusqu'à épuisement du stock / Hasta agotar existencias

Griffprofil GEO 18  
Poignée GEO 18  
Perfil GEO 18

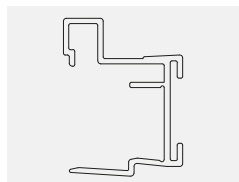

A-R18GE02-270-05*	2700	Aluminium / aluminium / aluminio	Aluminium / aluminium / aluminio



\*Produkt erhältlich auf individuelle Bestellung / Produit disponible sur demande / Producto disponible bajo demanda



Griffprofil NOVO 2  
Poignée NOVO 2  
Perfil NOVO 2

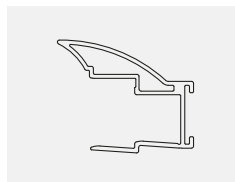

	 L mm		
A-RNOV2-270-05	2700	Aluminium / aluminium / aluminio	Aluminium, aluminium, aluminio
A-RNOV2-270-10		weiß / blanc / blanco weiß / blanc / blanco	
A-RNOV2-270-20M		schwarz matt / noir mat / negro mate	
A-RNOV2-270-90		Champagner / champagne / champán	



Griffprofil NOVO S  
Poignée NOVO S  
Perfil NOVO S

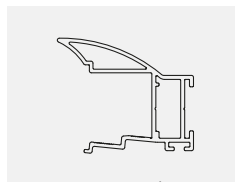

	 L mm		
A-R18NOVS-270-05	2700	Aluminium / aluminium / aluminio	Aluminium, aluminium, aluminio
A-R18NOVS-270-10		weiß / blanc / blanco	
A-R18NOVS-270-20M		schwarz / noir / negro	
A-R18NOVS-270-90		Champagner / champagne / champán	



Griffprofil NOVO S 19  
Poignée NOVO S 19  
Perfil NOVO S 19

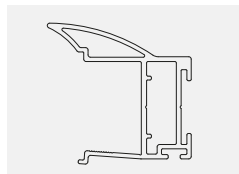

	 L mm		
A-R19NOVS-300-05*	3000	Aluminium / aluminium / aluminio	Aluminium / aluminium / aluminio



\*Bis die Bestände ausgehen / Jusqu'à épuisement du stock / Hasta agotar existencias

Griffprofil CARO  
Poignée CARO  
Perfil CARO

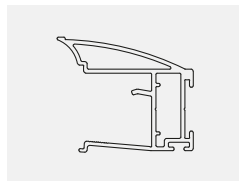





	 L mm		
A-R18CARO-270-05	2700	Aluminium / aluminium / aluminio	Aluminium, aluminium, aluminio
A-R18CARO-270-90		Champagner / champagne / champán	

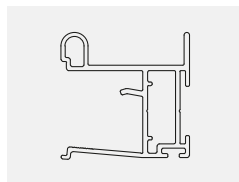

Griffprofil VISTA  
Poignée VISTA  
Perfil VISTA



	 L mm		
A-R18VIS-270-05	2700	Aluminium / aluminium / aluminio	Aluminium, aluminium, aluminio
A-R18VIS-270-20M		schwarz matt / noir mat / negro mate	
A-R18VIS-270-90		Champagner / champagne / champán	

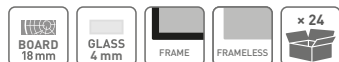



Griffprofil NERO  
Poignée NERO  
Perfil NERO

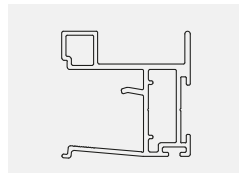

A-R18NERO-270-05	2700	Aluminium / aluminium / aluminio	Aluminium, aluminium, aluminio
A-R18NERO-270-10		weiß / blanc / blanco	
A-R18NERO-270-20M		schwarz / noir / negro	
A-R18NERO-270-90		Champagner / champagne / champán	

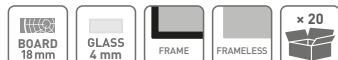

Griffprofil NERO 19  
Poignée NERO 19  
Perfil NERO 19

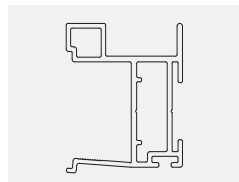

A-R19NERO-300-05	3000	Aluminium / aluminium / aluminio	Aluminium / aluminium / aluminio



Griffprofil COTE  
Poignée COTE  
Perfil COTE

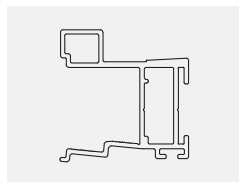

A-R18COTE-270-05	2700	Aluminium / aluminium / aluminio	Aluminium, aluminium, aluminio
A-R18COTE-270-90		Champagner / champagne / champán	



Griffprofil LOCA  
Poignée LOCA  
Perfil LOCA

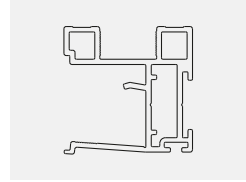





	 L mm		
A-R18LOCA-305-05	3050	Aluminium / aluminium / aluminio	
A-R18LOCA-305-90		Champagner / champagne / champán	

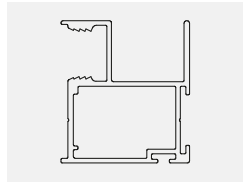

Griffprofil FLAT LINE  
Poignée FLAT LINE  
Perfil FLAT LINE







	 L mm		
A-R10FL-270-05	2700	Aluminium / aluminium / aluminio	
A-R10FL-270-10		weiß / blanc / blanco	
A-R10FL-270-20M		schwarz matt / noir mat / negro mate	
A-R10FL-270-90		Champagner / champagne / champán	

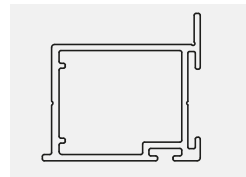

Griffprofil MOVENA  
Poignée MOVENA  
Perfil MOVENA



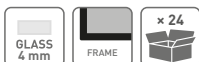

	 L mm		
A-R4MOV-270-05	2700	Aluminium / aluminium / aluminio	

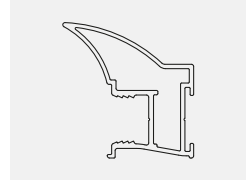

Griffprofil NOVO 10  
Poignée NOVO 10  
Perfil NOVO 10



	 L mm		
A-R10NOV-270-05	2700	Aluminium / aluminium / aluminio	Aluminium, aluminium, aluminio
A-R10NOV-270-10		weiß / blanc / blanco	
A-R10NOV-270-20M		schwarz matt / noir mat / negro mate	
A-R10NOV-270-90		Champagner / champagne / champán	



Griffprofil FORM  
Poignée FORM  
Perfil FORM

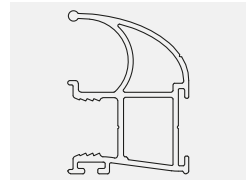

	 L mm		
A-R10FORM-270-05	2700	Aluminium / aluminium / aluminio	Aluminium, aluminium, aluminio
A-R10FORM-270-90		weiß / blanc / blanco	



Griffprofil TRAF0  
Poignée TRAF0  
Perfil TRAF0



	 L mm		
A-R10TRAF0-270-05	2700	Aluminium / aluminium / aluminio	Aluminium, aluminium, aluminio
A-R10TRAF0-270-90		Champagner / champagne / champán	



Griffprofil TORO  
Poignée TORO  
Perfil TORO

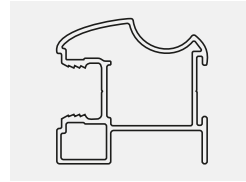





				
A-R10TORO-270-05	2700	Aluminium / aluminium / aluminio		Aluminium, aluminium, aluminio
A-R10TORO-270-90*		Champagner / champagne / champán		

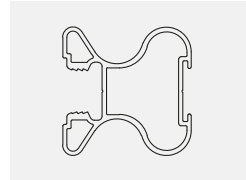

\*Bis die Bestände ausgehen / Jusqu'à épuisement du stock / Hasta agotar existencias

Griffprofil FALDA  
Poignée FALDA  
Perfil FALDA



				
A-R10FALDA-270-05	2700	Aluminium / aluminium / aluminio		Aluminium, aluminium, aluminio
A-R10FALDA-270-90		Champagner / champagne / champán		
A-R10FALDA-270-20M		schwarz / noir / negro		



Griffprofil ARCO\*  
Poignée ARCO\*  
Perfil ARCO\*

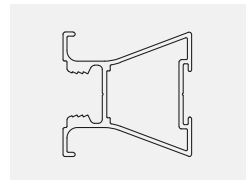







				
A-R10ARCO-270-05	2700	Aluminium / aluminium / aluminio		Aluminium, aluminium, aluminio
A-R10ARCO-270-90		Champagner / champagne / champán		

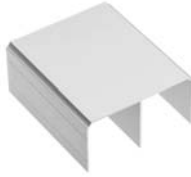

\*Bis die Bestände ausgehen / Jusqu'à épuisement du stock / Hasta agotar existencias

Obere Laufschiene  
 Rail supérieur  
 Carril superior







	 L mm		
A-TG-170-05	1700	Aluminium / aluminium / aluminio	 Aluminium, aluminium, aluminio
A-TG-170-10		weiß / blanc / blanco	
A-TG-170-20M		schwarz / noir / negro	
A-TG-170-90		Champagner / champagne / champán	
A-TG-235-05	2350	Aluminium / aluminium / aluminio	
A-TG-235-10		weiß / blanc / blanco	
A-TG-235-20M		schwarz / noir / negro	
A-TG-235-90		Champagner / champagne / champán	
A-TG-300-05	3000	Aluminium / aluminium / aluminio	
A-TG-300-10		weiß / blanc / blanco	
A-TG-300-20M		schwarz / noir / negro	
A-TG-300-90		Champagner / champagne / champán	
A-TG-405-05	4050	Aluminium / aluminium / aluminio	
A-TG-405-10		weiß / blanc / blanco	
A-TG-405-20M		schwarz / noir / negro	
A-TG-405-90		Champagner / champagne / champán	
A-TG-600-05	6000	Aluminium / aluminium / aluminio	
A-TG-600-10		weiß / blanc / blanco	
A-TG-600-20M		schwarz / noir / negro	
A-TG-600-90		Champagner / champagne / champán	



Untere Laufschiene EVO  
Rail inférieur EVO  
Carril inferior EVO



	 L mm		
A-TDEVO-170-05	1700	Aluminium / aluminium / aluminio	Aluminium, aluminium, aluminio
A-TDEVO-170-10		weiß / blanc / blanco	
A-TDEVO-170-20M		schwarz / noir / negro	
A-TDEVO-170-90	Champagner / champagne / champán		
A-TDEVO-235-05	2350	Aluminium / aluminium / aluminio	
A-TDEVO-235-10		weiß / blanc / blanco	
A-TDEVO-235-20M		schwarz / noir / negro	
A-TDEVO-235-90	Champagner / champagne / champán		
A-TDEVO-300-05	3000	Aluminium / aluminium / aluminio	
A-TDEVO-300-10		weiß / blanc / blanco	
A-TDEVO-300-20M		schwarz / noir / negro	
A-TDEVO-300-90	Champagner / champagne / champán		
A-TDEVO-405-05	4050	Aluminium / aluminium / aluminio	
A-TDEVO-405-10		weiß / blanc / blanco	
A-TDEVO-405-20M		schwarz / noir / negro	
A-TDEVO-405-90	Champagner / champagne / champán		
A-TDEVO-600-05	6000	Aluminium / aluminium / aluminio	
A-TDEVO-600-10		weiß / blanc / blanco	
A-TDEVO-600-20M		schwarz / noir / negro	
A-TDEVO-600-90	Champagner / champagne / champán		



Abdeckung EVO  
Cache rail EVO  
Embellecedor EVO



	 L mm		
A-MEVO-170-05	1700	Aluminium / aluminium / aluminio	Aluminium, aluminium, aluminio
A-MEVO-170-10A		weiß / blanc / blanco	
A-MEVO-170-20M		schwarz / noir / negro	
A-MEVO-170-90	Champagner / champagne / champán		
A-MEVO-235-05	2350	Aluminium / aluminium / aluminio	
A-MEVO-235-10A		weiß / blanc / blanco	
A-MEVO-235-20M		schwarz / noir / negro	
A-MEVO-235-90	Champagner / champagne / champán		
A-MEVO-300-05	3000	Aluminium / aluminium / aluminio	
A-MEVO-300-10A		weiß / blanc / blanco	
A-MEVO-300-20M		schwarz / noir / negro	
A-MEVO-300-90	Champagner / champagne / champán		
A-MEVO-405-05	4050	Aluminium / aluminium / aluminio	
A-MEVO-405-10		weiß / blanc / blanco	
A-MEVO-405-20M		schwarz / noir / negro	
A-MEVO-405-90	Champagner / champagne / champán		



Untere Laufschiene EVO 2  
 Rail inférieur EVO 2  
 Carril inferior EVO 2







	 L mm		
A-TDEV02-170-05	1700	Aluminium / aluminium / aluminio	Aluminium, aluminium, aluminio
A-TDEV02-170-90*		Champagner / champagne / champán	
A-TDEV02-235-05	2350	Aluminium / aluminium / aluminio	
A-TDEV02-235-90*		Champagner / champagne / champán	
A-TDEV02-300-05	3000	Aluminium / aluminium / aluminio	
A-TDEV02-300-90*		Champagner / champagne / champán	
A-TDEV02-405-05	4050	Aluminium / aluminium / aluminio	
A-TDEV02-405-90*		Champagner / champagne / champán	
A-TDEV02-600-05	6000	Aluminium / aluminium / aluminio	
A-TDEV02-600-90*		Champagner / champagne / champán	



\*Bis die Bestände ausgehen / Jusqu'à épuisement du stock / Hasta agotar existencias

Untere Laufschiene PRO  
 Rail inférieur PRO  
 Carril inferior PRO



	 L mm		
A-TDPRO-170-05	1700	Aluminium / aluminium / aluminio	Aluminium, aluminium, aluminio
A-TDPRO-170-10		weiß / blanc / blanco	
A-TDPRO-170-20M		schwarz / noir / negro	
A-TDPRO-170-90		Champagner / champagne / champán	
A-TDPRO-235-05	2350	Aluminium / aluminium / aluminio	
A-TDPRO-235-10		weiß / blanc / blanco	
A-TDPRO-235-20M		schwarz / noir / negro	
A-TDPRO-235-90		Champagner / champagne / champán	
A-TDPRO-300-05	3000	Aluminium / aluminium / aluminio	
A-TDPRO-300-10		weiß / blanc / blanco	
A-TDPRO-300-20M		schwarz / noir / negro	
A-TDPRO-300-90		Champagner / champagne / champán	
A-TDPRO-405-05	4050	Aluminium / aluminium / aluminio	
A-TDPRO-405-10		weiß / blanc / blanco	
A-TDPRO-405-20M		schwarz / noir / negro	
A-TDPRO-405-90		Champagner / champagne / champán	
A-TDPRO-600-05	6000	Aluminium / aluminium / aluminio	
A-TDPRO-600-10		weiß / blanc / blanco	
A-TDPRO-600-20M		schwarz / noir / negro	
A-TDPRO-600-90		Champagner / champagne / champán	



Abdeckung PRO  
Cache rail PRO  
Embellecedor PRO-Mask



	 L mm		
A-MPRO-170-05	1700	Aluminium / aluminium / aluminio	Aluminium, aluminium, aluminio
A-MPRO-170-10		weiß / blanc / blanco	
A-MPRO-170-20M		schwarz / noir / negro	
A-MPRO-170-90		Champagner / champagne / champán	
A-MPRO-235-05	2350	Aluminium / aluminium / aluminio	Aluminium, aluminium, aluminio
A-MPRO-235-10		weiß / blanc / blanco	
A-MPRO-235-20M		schwarz / noir / negro	
A-MPRO-235-90		Champagner / champagne / champán	
A-MPRO-300-05	3000	Aluminium / aluminium / aluminio	Aluminium, aluminium, aluminio
A-MPRO-300-10		weiß / blanc / blanco	
A-MPRO-300-20M		schwarz / noir / negro	
A-MPRO-300-90		Champagner / champagne / champán	
A-MPRO-405-05	4050	Aluminium / aluminium / aluminio	Aluminium, aluminium, aluminio
A-MPRO-405-10		weiß / blanc / blanco	
A-MPRO-405-20M		schwarz / noir / negro	
A-MPRO-405-90		Champagner / champagne / champán	



Obere Leiste 18/4 mm  
Rail supérieur 18/4 mm  
Perfil superior 18/4 mm



	 L mm		
A-LG18-170-05*	1700	Aluminium / aluminium / aluminio	Aluminium, aluminium, aluminio
A-LG18-170-90*		Champagner / champagne / champán	
A-LG18-235-05*	2350	Aluminium / aluminium / aluminio	
A-LG18-235-90*		Champagner / champagne / champán	
A-LG18-300-05	3000	Aluminium / aluminium / aluminio	
A-LG18-300-10		weiß / blanc / blanco	
A-LG18-300-20M		schwarz / noir / negro	
A-LG18-300-90		Champagner / champagne / champán	
A-LG18-405-05*	4050	Aluminium / aluminium / aluminio	
A-LG18-405-10*		weiß / blanc / blanco	
A-LG18-405-90*		Champagner / champagne / champán	
A-LG18-600-05*	6000	Aluminium / aluminium / aluminio	
A-LG18-600-90*		Champagner / champagne / champán	





Untere Leiste 18/4 mm  
 Rail inférieur 18/4 mm  
 Perfil inferior 18/4 mm



	 L mm		
A-LD18-170-05*	1700	Aluminium / aluminium / aluminio	
A-LD18-170-90*		Champagner / champagne / champán	
A-LD18-235-05*	2350	Aluminium / aluminium / aluminio	
A-LD18-235-90*		Champagner / champagne / champán	
A-LD18-300-05	3000	Aluminium / aluminium / aluminio	
A-LD18-300-10		weiß / blanc / blanco	
A-LD18-300-20M		schwarz / noir / negro	
A-LD18-300-90		Champagner / champagne / champán	
A-LD18-405-05*	4050	Aluminium / aluminium / aluminio	
A-LD18-405-10*		weiß / blanc / blanco	
A-LD18-405-90*		Champagner / champagne / champán	
A-LD18-600-05*	6000	Aluminium / aluminium / aluminio	
A-LD18-600-90*		Champagner / champagne / champán	



\*Bis die Bestände ausgehen / Jusqu'à épuisement du stock / Hasta agotar existencias

Obere Leiste 19 mm  
 Rail supérieur 19 mm  
 Perfil superior 19 mm

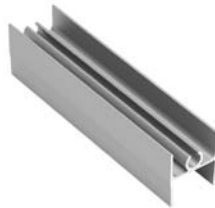

	 L mm		
A-LG19-300-05	3000	Aluminium, aluminium, aluminio	Aluminium, aluminium, aluminio

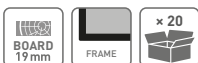

Untere Leiste 19 mm  
 Rail inférieur 19 mm  
 Perfil inferior 19 mm



	 L mm		
A-LD19-300-05	3000	Aluminium, aluminium, aluminio	Aluminium, aluminium, aluminio

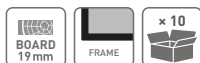

Obere Leiste 10/4 mm  
 Rail supérieur 10/4 mm  
 Perfil superior 10/4 mm

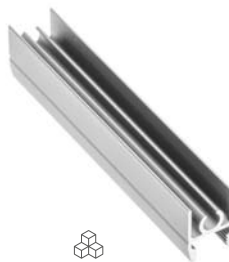

	 L mm		
A-LG10-170-05*	1700	Aluminium / aluminium / aluminio	Aluminium, aluminium, aluminio
A-LG10-235-05*	2350	Aluminium / aluminium / aluminio	
A-LG10-235-90*		Champagner / champagne / champán	
A-LG10-300-05	3000	Aluminium / aluminium / aluminio	
A-LG10-300-10		weiß / blanc / blanco	
A-LG10-300-20M		schwarz matt / noir mat / negro mate	
A-LG10-300-90		Champagner / champagne / champán	
A-LG10-405-05*	4050	Aluminium / aluminium / aluminio	
A-LG10-405-90*		Champagner / champagne / champán	
A-LG10-600-05*	6000	Aluminium / aluminium / aluminio	
A-LG10-600-90*		Champagner / champagne / champán	



Untere Leiste 10/4 mm  
 Rail inférieur 10/4 mm  
 Perfil inferior 10/4 mm





	 mm		
A-LD10-170-05*	1700	Aluminium / aluminium / aluminio	Aluminium, aluminium, aluminio
A-LD10-235-05*	2350	Aluminium / aluminium / aluminio	
A-LD10-235-90*		Champagner / champagne / champán	
A-LD10-300-05	3000	Aluminium / aluminium / aluminio	
A-LD10-300-10		weiß / blanc / blanco	
A-LD10-300-20M		schwarz matt / noir mat / negro mate	
A-LD10-300-90		Champagner / champagne / champán	
A-LD10-405-05*	4050	Aluminium / aluminium / aluminio	
A-LD10-405-90*		Champagner / champagne / champán	
A-LD10-600-05*	6000	Aluminium / aluminium / aluminio	
A-LD10-600-90*		Champagner / champagne / champán	



\*Bis die Bestände ausgehen / Jusqu'à épuisement du stock / Hasta agotar existencias

Obere Leiste 4 mm  
 Rail supérieur 4 mm  
 Perfil superior 4 mm





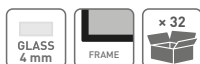

	 mm		
A-LG4MOV-300-05	3000	Aluminium / aluminium / aluminio	Aluminium, aluminium, aluminio



Untere Leiste 4 mm  
 Rail inférieur 4 mm  
 Perfil inferior 4 mm





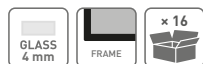

	 L mm		
A-LD4MOV-300-05	3000	Aluminium / aluminium / aluminio	Aluminium, aluminium, aluminio



Obere Leiste FL 10/4 mm  
 Rail supérieur FL 10/4 mm  
 Perfil superior FL 10/4 mm







	 L mm		
A-LG10FL-300-05	3000	Aluminium / aluminium / aluminio	Aluminium, aluminium, aluminio
A-LG10FL-300-10		weiß / blanc / blanco	
A-LG10FL-300-20M		schwarz matt / noir mat / negro mate	
A-LG10FL-300-90		Champagner / champagne / champán	



Untere Leiste FL 10,4 mm  
 Rail inférieur FL 10/4 mm  
 Perfil inferior FL 10/4 mm



			
A-LD10FL-300-05	3000	Aluminium / aluminium / aluminio	Aluminium, aluminium, aluminio
A-LD10FL-300-10		weiß / blanc / blanco	
A-LD10FL-300-20M		schwarz matt / noir mat / negro mate	
A-LD10FL-300-90		Champagner / champagne / champán	



Winkelprofil  
 Cornières  
 Perfil ángulo recto







			
A-K18-300-05	3000	Aluminium / aluminium / aluminio	Aluminium, aluminium, aluminio
A-K18-300-10		weiß / blanc / blanco	
A-K18-300-20M		schwarz / noir / negro	
A-K18-300-90		Champagner / champagne / champán	



Profil C18  
 Profilé C18  
 Perfil C18







	 L mm		
A-C18-300-S-05	3000	Aluminium / aluminium / aluminio	Aluminium, aluminium, aluminio
A-C18-300-S-10		weiß / blanc / blanco	
A-C18-300-S-20M		schwarz matt / noir mat / negro mate	
A-C18-300-S-90		Champagner / champagne / champán	



Profil T18  
 Profilé T18  
 Perfil T18



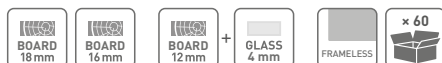

	 L mm		
A-T18-300-05	3000	Aluminium / aluminium / aluminio	Aluminium, aluminium, aluminio
A-T18-300-10		weiß / blanc / blanco	
A-T18-300-90		Champagner / champagne / champán	
A-T18-300-20M		schwarz / noir / negro	



Profil H16  
 Profilé H16  
 Perfil H16



	 L mm		
A-H16-300-05	3000	Aluminium / aluminium / aluminio	Aluminium, aluminium, aluminio
A-H16-300-90*		Champagner / champagne / champán	







\*Bis die Bestände ausgehen / Jusqu'à épuisement du stock / Hasta agotar existencias



Profil H18  
 Profilé H18  
 Perfil H18



	 L mm		
A-H18-300-05	3000	Aluminium / aluminium / aluminio	Aluminium, aluminium, aluminio
A-H18-300-10*		weiß / blanc / blanco	
A-H18-300-20M		schwarz / noir / negro	
A-H18-300-90		Champagner / champagne / champán	



Profil H18 RA  
 Profilé H18 RA  
 Perfil H18 RA



	 L mm		
A-HR18-300-05RA	3000	Aluminium / aluminium / aluminio	Aluminium, aluminium, aluminio
A-HR18-300-90RA		Champagner / champagne / champán	



Profil HR18  
 Profilé HR18  
 Perfil HR18

A-HR18-300-05	3000	Aluminium / aluminium / aluminio	Aluminium, aluminium, aluminio
A-HR18-300-10		weiß / blanc / blanco	
A-HR18-300-20M		schwarz / noir / negro	
A-HR18-300-90		Champagner / champagne / champán	

 Profil HRS18  
 Profilé HRS18  
 Perfil HRS18

A-HRS18-170-05*	1700	Aluminium / aluminium / aluminio	Aluminium, aluminium, aluminio
A-HRS18-170-90*		Champagner / champagne / champán	
A-HRS18-235-05*	2350	Aluminium / aluminium / aluminio	
A-HRS18-235-90*		Champagner / champagne / champán	
A-HRS18-300-05	3000	Aluminium / aluminium / aluminio	
A-HRS18-300-90		Champagner / champagne / champán	
A-HRS18-405-05*	4050	Aluminium / aluminium / aluminio	
A-HRS18-405-90*		Champagner / champagne / champán	
A-HRS18-600-05*	6000	Aluminium / aluminium / aluminio	
A-HRS18-600-90*		Champagner / champagne / champán	



\*Bis die Bestände ausgehen / Jusqu'à épuisement du stock / Hasta agotar existencias





 Profil HR19  
 Profilé HR19  
 Perfil HR19



A-HR19-300-05	3000	Aluminium / aluminium / aluminio	Aluminium / aluminium / aluminio







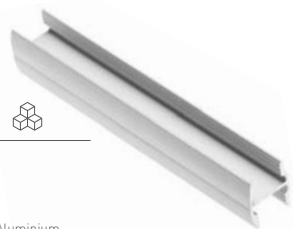

Profil HR10  
 Profilé HR10  
 Perfil HR10

			
A-HR10-235-05*	2350	Aluminium / aluminium / aluminio	Aluminium, aluminium, aluminio
A-HR10-235-90*		Champagner / champagne / champán	
A-HR10-300-05	3000	Aluminium / aluminium / aluminio	
A-HR10-300-10		weiß / blanc / blanco	
A-HR10-300-90	Champagner / champagne / champán		
A-HR10-405-05*	4500	Aluminium / aluminium / aluminio	
A-HR10-405-90*		Champagner / champagne / champán	
A-HR10-600-05*	6000	Aluminium / aluminium / aluminio	
A-HR10-600-90*		Champagner / champagne / champán	



\*Bis die Bestände ausgehen / Jusqu'à épuisement du stock / Hasta agotar existencias

 Profil HRS10  
 Profilé HRS10  
 Perfil HRS10

			
A-HRS10-170-05*	1700	Aluminium / aluminium / aluminio	Aluminium, aluminium, aluminio
A-HRS10-300-05	3000	Champagner / champagne / champán	
A-HRS10-300-90		Aluminium / aluminium / aluminio	
A-HRS10-405-05*	4050	Aluminium / aluminium / aluminio	
A-HRS10-600-05*	6000	Aluminium / aluminium / aluminio	

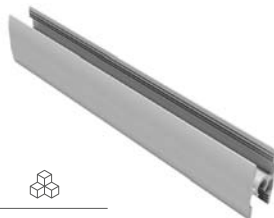

\*Bis die Bestände ausgehen / Jusqu'à épuisement du stock / Hasta agotar existencias



 Profil HR10 FL  
 Profilé HR10 FL  
 Perfil HR10 FL

			
A-HR10FL-300-05	3000	Aluminium / aluminium / aluminio	Aluminium, aluminium, aluminio
A-HR10FL-300-10		weiß / blanc / blanco	
A-HR10FL-300-20M		schwarz matt / noir mat / negro mate	
A-HR10FL-300-90		Champagner / champagne / champán	



Obere Laufrollen PG-18  
 Guide supérieur PG-18  
 Ruedines superiores PG-18





		
A-PG-18	50	Stahl + Kunststoff, acier + Plastique, acero + plastico



Obere Laufrollen PGR-18  
 Guide supérieur PGR-18  
 Ruedines superiores PGR-18





		
A-PGR-18	50	Stahl + Kunststoff, acier + Plastique, acero + plastico



Obere Laufrollen PGR-10  
 Guide supérieur PGR-10  
 Ruedines superiores PGR-10





		
A-PGR-10	50	Stahl + Kunststoff, acier + Plastique, acero + plastico



Obere Laufrollen PGR-10, symmetrisch  
 Guide supérieur PGR-10 symétrique  
 Ruedines superiores PGR-10 simétrica





		
A-PGR-10S	50	Stahl + Kunststoff, acier + Plastique, acero + plastico



Distanzplatte  
 Plaque d'écartement  
 Placa separadora





		
A-DPG-16	50	Stahl, acier, acero,



Unterer Laufwagen EVO 2  
 Chariot inférieur EVO 2  
 Ruedin inferior EVO 2





		
A-WD-EVO2	50	Stahl + Kunststoff, acier + Plastique, acero + plastico



Haken EVO2  
Gâche EVO2  
Enganche EVO2





		
A-ZAC-WDEV02	50	Stahl + Kunststoff, acier + Plastique, acero + plastico



Unterer Laufwagen PRO  
Chariot inférieur PRO  
Ruedin inferior PRO





		
A-WD-PRO	50	Stahl + Kunststoff, acier + Plastique, acero + plastico



Unterer Laufwagen EVO für Rahmensysteme  
Chariot inférieur du cadre EVO  
Ruedin inferior EVO bastidor





		
A-WDR-EVO	50	Stahl + Kunststoff, acier + Plastique, acero + plastico



Unterer Laufwagen PRO für Rahmensysteme  
 Chariot inférieur du cadre PRO  
 Ruedin inferior PRO bastidor





		
A-WDR-PRO	50	Stahl + Kunststoff, acier + Plastique, acero + plastico



Oberer Feststeller  
 Positionneur supérieur  
 Posicionador superior





		
A-PTG	50	Kunststoff, Plastique, plastico



Unterer Feststeller PRO  
 Positionneur inférieur PRO  
 Posicionador inferior PRO



		
A-PTD	50	Stahl, acier, acero,



Staubschutzbürste 4,8 x 4 mm  
 Brosse de pare-chocs 4,8 x 4 mm  
 Protección antigolpes 4,8 x 4 mm



		
A-SO-R-48X4	grau / gris / gris	Kunststoff, Plastique, plástico
A-SO-R-48X4-20	schwarz / noir / negro	



Breite Staubschutzbürste 14,5 x 4 mm  
 Brosse de pare-chocs large 14,5 x 4 mm  
 Protección antigolpes 4,8 x 4 mm



		
A-SO-R-145X4	grau / gris / gris	Kunststoff, Plastique, plástico
A-SO-R-145X4-10	weiß / blanc / blanco	
A-SO-R-145X4-20	schwarz / noir / negro	



Staubschutzbürste ohne Klebstoff 4,8 x 7 mm  
 Brosse anti-poussière sans adhésif 4,8 x 7 mm  
 Protección antipolvo sin adhesivo 4,8 x 7 mm



		
A-SP-R-48X7	grau, gris, gris	Kunststoff, Plastique, plástico



Staubschutzbürste mit Klebstoff 7 x 12 mm  
 Brosse anti-poussière avec adhésif 7 x 12 mm  
 Protección antipolvo con adhesivo 7 x 12 mm



		
A-SP-R-7X12	grau, gris, gris	Kunststoff, Plastique, plástico



Staubschutzbürste ohne Klebstoff 4,8 x 12 mm  
 Brosse anti-poussière sans adhésif 4,8 x 12 mm  
 Cepillo antipolvo sin adhesivo 4,8 x 12 mm



		
A-SP-R-48X12	grau, gris, gris	Kunststoff, Plastique, plástico



Keil für Griffprofile  
 Cale pour poignée  
 Cuña para soportes



		
A-KR-4	weiß / blanc / blanco	Kunststoff, Plastique, plástico
A-KR-4-20	schwarz / noir / negro	



Keil für Horizontalleisten  
 Cale pour bandes horizontales  
 Cuña para barras horizontales



		
A-KLP-4	weiß / blanc / blanco	Kunststoff, Plastique, plástico
A-KLP-4-20	schwarz / noir / negro	



Unterer Schienenbefestigungsclip EVO 2  
 Clip de montage sur rail inférieur EVO 2  
 Clip de montaje del riel inferior EVO 2



		
A-ZAT-TDEV02	milchig laiteux leche	Kunststoff, Plastique, plástico



Dichtung Typ U, mittelhart  
 Joint d'étanchéité de type U, moyennement dur  
 Junta tipo U, semidura







			
A-USZCZ-U4	100	transparent transparent transparente	Kunststoff, Plastique, plástico





Dichtung Typ CH, weich  
 Joint d'étanchéité type CH, souple  
 Junta tipo CH, blanda







	 L m		
A-USZCZ-CHM4	120	průhledný / priehľadná / átlátszó / transparent	Kunststoff, Plastique, plastico
A-USZCZ-CHM4-20	150	schwarz / noir / negro	



Dichtung für untere Laufschiene EVO 2  
 Joint d'étanchéité pour rail inférieur EVO 2  
 Junta para carril inferior EVO 2





	 L m		
A-USZCZ-TDEV02	200	milchig laiteux leche	PVC



Blechschaube 6,3 x 40 mm  
 Vis tôle 6,3 x 40 mm  
 Tornillo para chapa 6,3 x 40 mm





	
A-B63-40	Stahl, acier, acero,



Blechschaube 6,3 x 32 mm  
 Vis tôle 6,3 x 32 mm  
 Tornillo para chapa 6,3 x 32 mm





	
A-B63-32*	Stahl, acier, acero,



\*Bis die Bestände ausgehen / Jusqu'à épuisement du stock / Hasta agotar existencias

Soft-Close-System SIMON, seitliche Montage  
 Amortisseur d'extrémité SIMON  
 Sistema de retención SIMON extremo



		
A-SOFT-30*	30	Stahl + Kunststoff, acier + Plastique, acero + plástico
A-SOFT-50*	50	



\*Bis die Bestände ausgehen / Jusqu'à épuisement du stock / Hasta agotar existencias



Soft-Close-System SIMON, mittige Montage  
 Amortisseur central SIMON  
 Sistema de retención SIMON central



		
A-MSOFT-RAMA*	50	Stahl + Kunststoff, acier + Plastique, acero + plástico



\*Bis die Bestände ausgehen / Jusqu'à épuisement du stock / Hasta agotar existencias





Soft-Close-System ZIMMER, seitliche Montage  
 Amortisseur d'extrémité ZIMMER  
 Sistema de retención ZIMMER extremo

		
A-SOFT-30Z	30	Stahl + Kunststoff, acier + Plastique, acero + plástico
A-SOFT-50Z	50	



Montageplatte für Soft-Close-System SIMON, mittige Montage  
 Kit d'adaptation pour amortisseur central  
 Conjunto de adaptadores para el sistema de retención central



		
A-MSOFT-ADAPT	50	Stahl, acier, acero,



Schloss für Schiebsysteme  
 Serrure pour systèmes de portes coulissantes  
 Cerradura para puertas correderas





	
ZZ-SP-105-05	Stahl + Kunststoff, acier + Plastique, acero + plastico



Bohrschablone mit Verriegelung  
 Gabarit de perçage avec serrage  
 Accesorio para taladrar con bloqueo



	
A-PW-RC-DOC	Stahl, acier, acero,



MITO  
MITO  
MITO



<p>Laufschiene MITO Rail MITO Carril MITO</p>	A-TMITO-200-00	200	50	Rohaluminium aluminium non allié aluminio bruto	Aluminium, aluminium, aluminio	56
	A-TMITO-250-00	250				
	A-TMITO-300-00	300				
	A-TMITO-200-05	200				
	A-TMITO-250-05	250				
	A-TMITO-300-05	300				
<p>Feststeller Positionneur Posicionador</p>	A-POZ-MITO	-	50	grau, gris, gris	Kunststoff, Plastique, plastico	2000
<p>Oberer Gleiter Chariot supérieur Ruedín superior</p>	A-SG-MITO	-	50	verzinkt galvanisé galvanizado	Stahl + Kunststoff, acier + Plastique, acero + plastico	400
<p>Unterer Laufwagen mit Kugellager Chariot inférieur avec roulement à billes Ruedín inferior con rodamiento de bolas</p>	A-RD-MITO	-				



Set MITO PLUS  
Ensemble MITO PLUS  
Conjunto MITO PLUS



2 obere Laufwagen mit Feder, 2 untere Laufwagen mit Kugellager, 1 Feststeller, Schraubenset  
2 chariots supérieurs à ressort, 2 chariots inférieurs à roulement à billes, 1 positionneur, jeu de vis  
2 Ruedines superiores con muelle, 2 ruedines inferiores con rodamientos de bolas, 1 posicionador, juego de tornillos



A-MITO-PLUS	50	verzinkt / galvanisé / galvanizado	Stahl / acier / acero
-------------	----	------------------------------------	-----------------------



Set OVERLINE  
Ensemble OVERLINE  
Kit OVERLINE



2 Stk. Außenwagen, 2 Stk. Innenwagen, 2 Stk. Feststeller, 2 Stk. untere Gleiter für Außentür, 2 Stk. untere Gleiter für Innentür  
2 pcs. de chariots extérieurs, 2 pcs. de chariots intérieurs, 2 pcs. de positionneurs, 2 pcs. de guides inférieurs glissières pour portes extérieures, 2 pcs. de guides inférieurs pour glissières de portes intérieures  
2 unidades de ruedines exteriores, 2 unidades de ruedines interiores, 2 unidades de posicionadores, 2 unidades de guías inferiores deslizantes de la puerta exterior, 2 unidades de guías inferiores deslizantes de la puerta interior

A-SN-FSET	50	verzinkt / galvanisé / galvanizado	Stahl + Kunststoff / acier + Plastique / acero + plastico /	10			
	Griffprofil RIVA Poignée RIVA Supporte RIVA	A-SN-R19RIV-270-05*	-	Aluminium, aluminium, aluminio	24		
	Profil C19 Profilé C19 Perfil C19	A-SN-K19-270-05*	-		48		
	Profil C18 Profilé C18 Perfil C18	A-C18-300-S-05	-		50		
	Obere Laufschiene Rail supérieur Carril superior	A-SN-TG-405-00	4050	50	Rohaluminium aluminium non allié aluminio bruto	Stahl, acier, acero,	80
	Untere Laufschiene Rail supérieur Carril inferior	A-SN-TDS-405-00			Aluminium, aluminium, aluminio	40	
	Soft-Close-System Amortisseur Sistema de retención	A-SN-SOFT-25Z	-	25	grau, gris, gris	Kunststoff, Plastique, plastico	100
		A-SN-SOFT-40Z	-				40
	Soft-Close-Set Ensemble d'amortisseur Conjunto para sist. retención 1 Öffner für Außentür und 1 Öffner für Innentür, 4 Stück Adapter, 1 Schraubenset 1 pcs. activateur de porte ext. et 1 pcs. int., 4 pcs. d'adaptateurs, 1 jeu de vis 1 ud. actuador de puerta ext. y 1 ud. int., 4 uds. de adaptadores, juego de tornillos	A-SN-ADSET	-	-	-	Stahl + Kunststoff, acier + Plastique, acero + plastico	100



\*Bis die Bestände ausgehen / Jusqu'à épuisement du stock / Hasta agotar existencias

Set OVERLINE PLUS  
Kit OVERLINE PLUS  
Conjunto OVERLINE PLUS



2 Stk. Außenwagen, 2 Stk. Innenwagen, 2 Stk. untere Laufrollen für Außentür, 2 Stk. untere Laufrollen für Innentür, 1 Schraubenset

2 pcs. de chariots extérieurs, 2 pcs. de chariots intérieurs, 2 pcs. de guides de rail inférieur de porte extérieure, 2 pcs. de guides de rail inférieur de porte intérieure, 1 jeu de vis

2 ruedines exteriores, 2 ruedines interiores, 2 guías inferiores deslizamiento de la puerta exterior, 2 guías inferiores deslizamiento puerta interior, 1 juego de tornillos

								
A-SN-HSET1	50	verzinkt / galvanisé / galvanizado	Stahl + Kunststoff / acier + Plastique / acero + plastico	1				
								
	Griffprofil RIVA Poignée RIVA Soporte RIVA	A-SN-R19RIV-270-05*	2700	-		24		
	Profil C19 Profilé C19 Perfil C19	A-SN-K19-270-05*		-	Aluminium, aluminium, aluminio	Aluminium, aluminium, aluminio	48	
	Profil C18 Profilé C18 Perfil C18	A-C18-300-S-05	3000	-			50	
	Obere Laufschiene Rail supérieur Carril superior	A-SN-TG-405-00	4050	-	Rohaluminium aluminium non allié aluminio bruto	Stahl, acier, acero,	80	
	Untere Laufschiene Rail supérieur Carril inferior	A-SN-TDT-405-00		-		Aluminium, aluminium, aluminio	20	
	Soft-Close-System Amortisseur Sistema de retención	A-SN-SOFT-25Z		-	25	-	100	
		A-SN-SOFT-40Z		-	40	-	Kunststoff, Plastique, plastico	
	Feststeller Positionneur Posicionador	A-SN-POZ		-	-	schwarz, noir, negro	20	
	Soft-Close-Set Ensemble d'amortisseur Conjunto para sistema de retención 1 Öffner für Außentür und 1 Öffner für Innentür 4 Stück Adapter 1 Schraubenset 1 pcs. activateur de porte ext. et 1 pcs. int. 4 pcs. d'adapteurs, 1 jeu de vis 1 ud. actuador de puerta ext. y 1 ud. int. 4 uds. de adaptadores, 1 juego de tornillos	A-SN-ADSET		-	-	-	Stahl + Kunststoff, acier + Plastique, acero + plastico	100

\*Bis die Bestände ausgehen / Jusqu'à épuisement du stock / Hasta agotar existencias

Tür-Spannvorrichtung  
Redresseur  
Rectificador



2 Stk. Zugband, 2 Stk. Spannplatte, 4 Stk. Druckplatte, Kappe, Positionierhülse, Einstellschlüssel

2 pcs. de cordon de serrage, 2 pcs. de plaque de tension, 4 pcs. de plaque d'appui, capuchon, douille de positionnement, clé de réglage

2 ruedines exteriores, 2 ruedines interiores, 2 guías inferiores deslizamiento puerta exterior, 2 guías inferiores deslizamiento puerta interior, 1 juego de tornillos



A-SN-SDP-TU

50

verzinkt / galvanisé / galvanizado

Stahl + Kunststoff / acier + Plastique / acero + plastico



Set QUANTUM  
Ensemble QUANTUM  
Kit QUANTUM



2 Stück Laufwagen, 2 Stück Feststeller, 2 Stück Führungsstücke, Schraubenset  
2 pcs. de chariots, 2 pcs. de butées, 2 pcs. de guides, jeu de vis  
2 ruedines, 2 topes, 2 guías, 1 juego de tornillos

A-BUDP-SET	50	Aluminium / aluminium / aluminio	Stahl + Kunststoff / acier + Plastique / acero + plastico	24

	mm	kg					
<p>Obere Laufschiene Rail supérieur Carril superior</p>	A-TG-BUD-200-00	2000	50	Rehaluminium aluminium non allié aluminio bruto	Aluminium, aluminium, aluminio	+	15
	A-TG-BUD-300-00	3000					
<p>Seitliche Halterung Support latéral Soporte lateral</p>	A-BUD-K-UB*	-	50	verzinkt galvanisé galvanizado	Stahl, acier, acero,	+	50
<p>Obere Halterung Support supérieur Soporte superior</p>	A-BUD-K-UB*	-					
<p>Halterung für Abdeckung der oberen Laufschiene Mousqueton rail supérieur Soporte del embellecedor del riel superior</p>	A-BUD-UM	60	50	Aluminium, aluminium, aluminio	Aluminium, aluminium, aluminio	-	250
<p>Rahmenhalterung (4 Stück) Support de cadre (4 pièces) Soporte de marco (4 uds.)</p>	A-BUD-UR	-	50	grau, gris, gris	Stahl + Kunststoff / acier + Plastique / acero + plastico	+	100
<p>Halterung für die Platte Support de panneau Soporte para placa</p>	A-BUD-UP	-	50	verzinkt galvanisé galvanizado	Stahl, acier, acero,	+	50 set

\*1 Set = 50 Stk. / 1 ensemble = 50 pc / 1 jgo. = 50 uds.





Set LOFT  
Ensemble LOFT  
Kit LOFT



Laufwagen x2, Führungsstück x1, Laufschiene 2m, Distanzhülse x5, Anschlagpuffer x2, Türabsturzicherung x2, Soft-Close-System x2, Aktivator x2, Schraubensatz

Chariots x2, guide x1, voie 2m, écarteur x5, butoirs x2, protection contre le décrochement de la porte x2, amortisseur x2, activateur x2, jeu de vis et de boulons

Ruedines x2, guía x1, carril 2m, distanciador x5, topes x2, protección contra la caída de la puerta x2, sistema de retención x2, activador x2, juego de tornillos y pernos



A-SN-LOFT-200-20M

100

schwarz / noir / negro

Stahl + Kunststoff / acier + Plastique / acero + plástico

1



Empfohlener Griff im Loft-Stil - UZ-STEP-160-20M

Poignée de style industriel recommandée - UZ-STEP-160-20M

Tirador recomendado tipo loft - UZ-STEP-160-20M



## MÖBELBELEUCHTUNG ÉCLAIRAGE DE MEUBLES ILUMINACIÓN DE MUEBLES

LED-Streifen	
Rubans LED	
Tiras LED	550 – 555
.....	
Aluminiumprofile für LED-Streifen	
Profils LED	
Perfiles LED	556 – 587
.....	
LED-Leuchten	
Luminaires LED	
Focos LED	588 – 595
.....	
Zubehör	
Accessoires	
Accesorios	596 – 625
.....	
Tisch-Steckdosenleisten	
Multiprises bureau	
Regletas de escritorio	626 – 647







## Easy-Click-Set in 5 Schritten vervollständigen Complétez le kit easy click en cinq pas Completa el set EASY CLICK en 5 pasos



1.

Wählen Sie LED Streifen  
choisissez une bande  
elige la tira LED

Wählen Sie die Anzahl der Abschnitte der LED-Streifen  
sélectionnez le nombre de section de ruban LED  
selecciona el número de secciones de tiras LED

2.

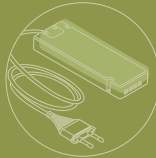

3.

passender Transformator  
alimentation adaptée  
fuente de alimentación  
correspondiente

wählen Sie das Profil. Profile werden als fertig  
konfektionierte 2-Meter-Sets verkauft, inklusive  
Profil, Abdeckung und 2 Blenden

choisissez un profil  
les profilés sont vendues sous forme d'un kit  
prêt de 2 m incluant un profil, un diffuseur  
et 2 bouchons d'extrémité"

elige un perfil  
Los perfiles se venden en sets de 2m que incluyen  
un perfil, un difusor y dos tapas"

4.

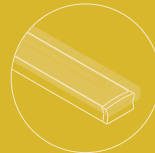

5.

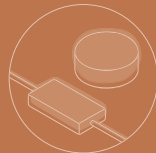

wählen Sie den Schalter  
choisissez un interrupteur  
elige el interruptor

Vorlage des Instllationsdiagramms  
 Exemple de diagramme d'installation  
 ejemplo de diagrama de instalación

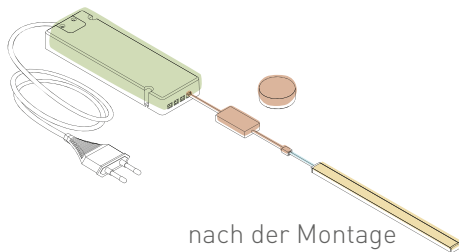

nach der Montage  
 après l'assemblage  
 después del montaje

Vorlage des Instllationsdiagramms  
 Exemple de diagramme d'installation  
 ejemplo de diagrama de instalación

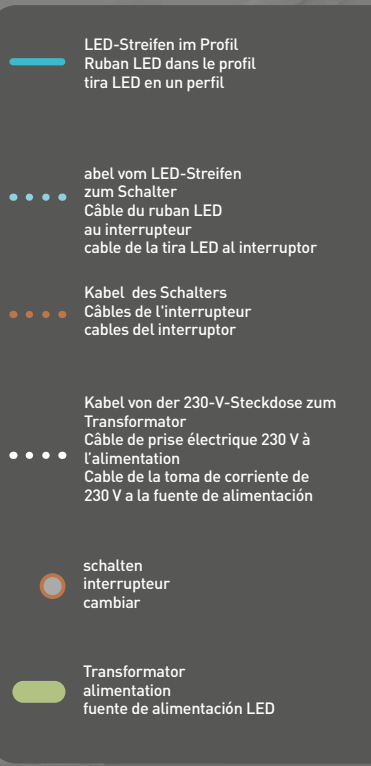

# LED-Band FLASH

## Ruban LED FLASH

### Tira LED FLASH



LD-3528-300-20-ZB	12 VDC 4,8 W/1 m 17 W/5 m	300 lm/m		20	120°	8	60/m	5	
LD-3528-300-20-NE4P									
LD-3528-300-20-CB									
LD-3528-300-65-ZB		280 lm/m		65					
LD-3528-300-65-NE4									
LD-3528-300-65-CB									
LD-3528-300-20-NI	-	blau/bleu/azul		20		120/m	2,5		
LD-3528-600-20-ZB	12 VDC 9,6 W/1 m 28 W/5 m	550 lm/m							
LD-3528-600-20-NE4									
LD-3528-600-20-CB									
LD-3528-600-65-ZB		520 lm/m						65	
LD-3528-600-65-NE4									
LD-3528-600-65-CB									
LD-2835-300-20-ZB	12 VDC 6 W/1 m 21 W/5 m	750 lm/m		20	8	60/m	5		
LD-2835-300-20-NE4P									
LD-2835-300-20-CB									
LD-2835-300-65-ZB		700 lm/m		65					
LD-2835-300-65-NE4									
LD-2835-300-65-CB									
LD-2835-300-20-CBN	12 VDC 11 W/1 m 33 W/5 m	1000 lm/m		20	10	120/m	2,5		
LD-2835-300-20-ZBN									
LD-2835-300-20-NE4N									
LD-2835-300-65-CBN		900 lm/m		65					
LD-2835-300-65-ZBN									
LD-2835-300-65-NE4N									
LD-2835-600-20-ZB	12 VDC 19 W/1 m 60 W/5 m	1600 lm/m		20	10	120/m	2,5		
LD-2835-600-20-NE4									
LD-2835-600-20-CB									
LD-2835-600-65-ZB		1350 lm/m		65					
LD-2835-600-65-NE4									
LD-2835-600-65-CB									





LD-2835-600-5MM-20-ZB	12 VDC 10 W/1 m 33 W/5 m	750 lm/m	● 6500 K	20	120°	5	120/m	2,5
LD-2835-600-5MM-20-NE4			● 4000 K					
LD-2835-600-5MM-20-CB			● 3200 K					
LD-2835-60-60-20-CCT	12 VDC 10 W/1 m 30 W/5 m	700 lm/m	● 3200 K ● 6500 K	20	120°	8	5	5
LD-5050-300-20-ZB	12 VDC 14,4 W/1 m 44 W/5 m	900 lm/m	● 6500 K	65	120°	10	60/m	5
LD-5050-300-20-NE4			● 4000 K					
LD-5050-300-20-CB			● 3200 K					
LD-5050-300-65-ZB	12 VDC 16 W/1 m 50 W/5 m	850 lm/m	● 6500 K	65	120°	10	60/m	5
LD-5050-300-65-NE4			● 4000 K					
LD-5050-300-65-CB			● 3200 K					
LD-5630-300-20-ZB	12 VDC 19 W/1 m 53 W/5 m	1750 lm/m	● 6500 K	20	120°	10	240/m	1,25
LD-5630-300-20-NE4			● 4000 K					
LD-5630-300-20-CB			● 3200 K					
LD-5630-300-65-ZB	12 VDC 16 W/1 m 50 W/5 m	1700 lm/m	● 6500 K	65	120°	10	60/m	5
LD-5630-300-65-NE4			● 4000 K					
LD-5630-300-65-CB			● 3200 K					
LD-3014-1200-20-ZB	12 VDC 19 W/1 m 53 W/5 m	1300 lm/m	● 6500 K	20	120°	10	240/m	1,25
LD-3014-1200-20-NE4			● 4000 K					
LD-3014-1200-20-CB			● 3200 K					
LD-RGB-150-20	12 VDC max 7,2 W/1 m 22 W/5 m	-	● RGB	65	120°	10	30/m	10
LD-RGB-150-65			● RGB					
LD-RGBW-300-20	12 VDC max 17 W/1 m	-	● RGBW	20			120°	10



LED-Band FLASH 50 m  
Ruban LED FLASH 50 m  
Tira LED FLASH 50 m



LD-3528-300-20-ZB-50	12 VDC 4,8 W/m	300 lm/m		● 6500 K	20	120°	8 mm	60/m	5
LD-3528-300-20-NE4P-50				● 4000 K					
LD-3528-300-20-CB-50				● 3200 K					
LD-3528-600-20-ZB-50	12 VDC 9,6 W/1 m	550 lm/m		● 6500 K	20	120°	8 mm	120/m	5
LD-3528-600-20-NE4-50				● 4000 K					
LD-3528-600-20-CB-50				● 3200 K					
LD-2835-300-20-ZB-50	12 VDC 6 W/m	750 lm/m		● 6500 K	20	120°	8 mm	60/m	5
LD-2835-300-20-NE4P-50				● 4000 K					
LD-2835-300-20-CB-50				● 3200 K					
LD-5050-300-20-NE4-50	12VDC 14,4W/m	900 lm/m		● 4000 K	20	120°	10 mm	120/m	5
LD-5630-300-20-NE4-50	12VDC 16W/m	1750 lm/m		● 4000 K					



LED-Band FLASH  
Ruban LED FLASH  
Tira LED FLASH









LD-2835-24V-300-20-ZB	24 V DC 12 W/1 m 48 W/5 m	780 lm/m		● 6500 K	20	120°	8 mm	60/m	10
LD-2835-24V-300-20-NE4				● 4000 K					
LD-2835-24V-300-20-CB				● 3200 K					
LD-2835-24V-600-20-ZB	24 V DC 21 W/1 m 78 W/5 m	1350 lm/m		● 6500 K	20	120°	10 mm	120/m	5
LD-2835-24V-600-20-NE4				● 4000 K					
LD-2835-24V-600-20-CB				● 3200 K					

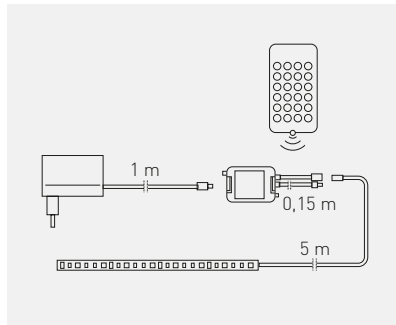



RGB-Set, LED-Band 5m, Steuergerät, Netzteil, Fernbedienung  
 Kit RGB, ruban LED 5 m, contrôleur, alimentation, télécommande  
 Kit RGB, tira LED 5 m, controlador, alimentador, control a distancia



					
LD-ZL5RGB150-00	12V	RGB	Kunststoff, Plastique, plastico	10	10



LED-Band COB  
Ruban LED COB  
Tira LED COB

NEW



LD-COB12V-20-ZBN	12V, 8W/m	600 lm/m	● 6500 K	IP20	1800	8 mm	320 led/m	2,5 cm	
LD-COB12V-20-CBN		600 lm/m	● 2700 K						
LD-COB12V-20-NEN		700 lm/m	● 4000 K						
LD-COB12V-20-ZBPQ	12V, 10W/m	800 lm/m	● 6500 K				480 led/m		
LD-COB12V-20-CBPQ		750 lm/m	● 2700 K						
LD-COB12V-20-NEPQ		800 lm/m	● 4000 K						



Ruban LED COB  
Tira LED COB  
LED-Band COB

NEW



LD-COB24V-20-ZBN	24V, 8W/m	650 lm/m	● 6500 K	IP20	1800	8 mm	320 led/m	2,5 cm
LD-COB24V-20-CBN		600 lm/m	● 2700 K					
LD-COB24V-20-NEN		600 lm/m	● 4000 K					



LED-Band NEON FLEX  
 Ruban LED NEON FLEX  
 Tira LED NEON FLEX



LD-NF-12V6x12-65-ZB	12 VDC 12 W/1 m 40 W/5 m	200 lm/m	● 6500 K	65	120°	6 mm	120/m	1
LD-NF-12V6x12-65-NE			● 4000 K					
LD-NF-12V6x12-65-CB			● 3000 K					

LD-ZASNF-12V6X12-65	Endkappen, bouchon d'extrémité, tapa lateral
LD-UNF-12V6X12-6X	Montageclip, clip de fixation, soporte



LD-ZASNF-12V6X12-65



LD-UNF-12V6X12-6X

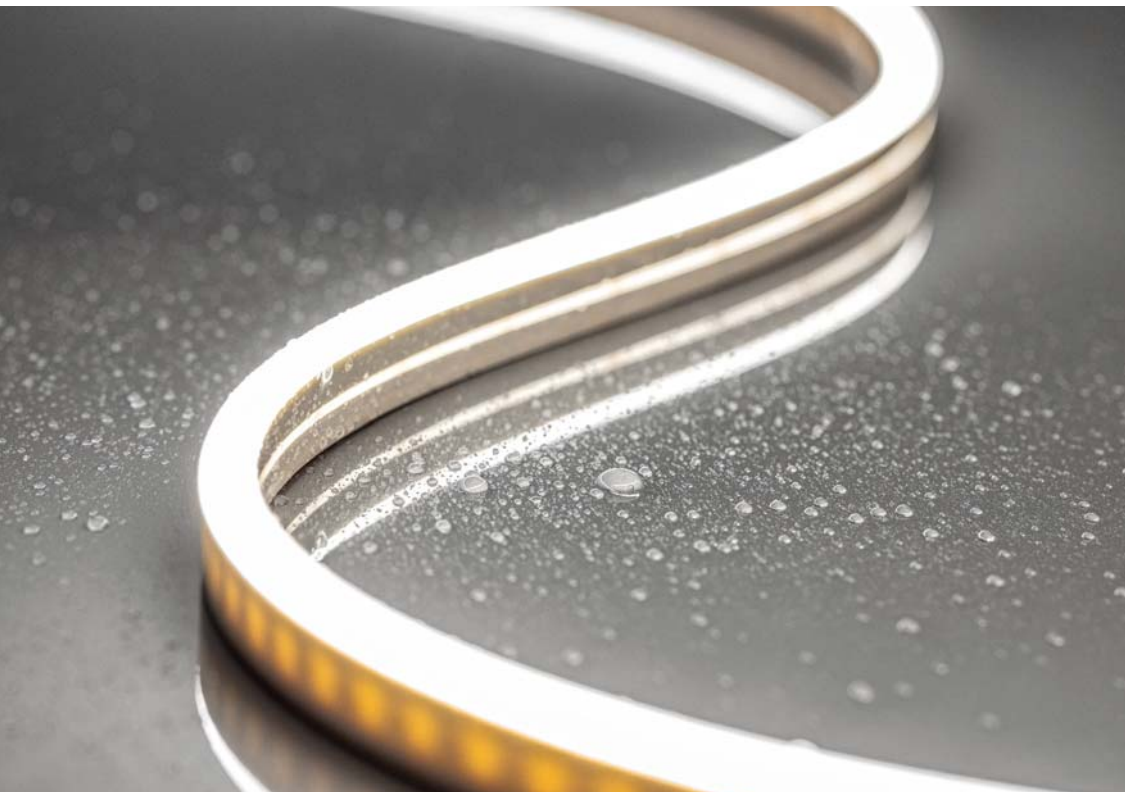

GLAX lineares Profil  
 Profilé GLAX linéaire  
 Perfil GLAX lineal

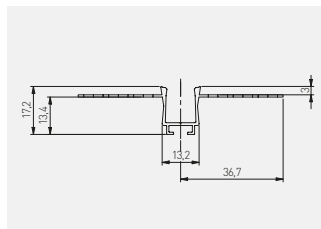
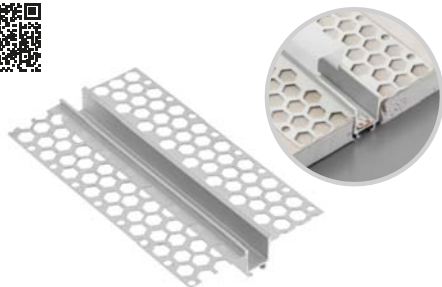

PA-GLAXGKL3M-00C	3	Profile, Profilé, Perfil	silberfarben, Argent, plata	Aluminium, aluminium, aluminio
PA-CPGLAXL-00	-	Stecker gerade, connecteur linéaire, conector lineal		rostfreier Stahl, Acier Inox, acero inoxidable
PA-CPGLAXAH-00	-	Anschluss horizontal, connecteur horizontal, conector horizontal		
PA-CPGLAXAV-00	-	Verbinder vertikal, connecteur vertical, conector vertical		
PA-OSMLGLAXM3M-00	3	Abdeckungen, protection, difusor	milchig, blanc dépoli, blanco mate	PC
PA-OSMLGLAXMK3M-00	3	quadratische Abdeckung, protection carrée, difusor cuadrada		
PA-OSMLGLAXM03M-00	3	Abdeckung rund, protection ronde, difusor redonda		
PA-OSMLGLAXT3M-00	3	dreieckige Abdeckung, protection triangulaire, difusor triangular		
PA-OSCLGLAXM3M-00	3	Abdeckung mini, protection mini, difusor mini		

Abdeckungen / Protection / difusor:

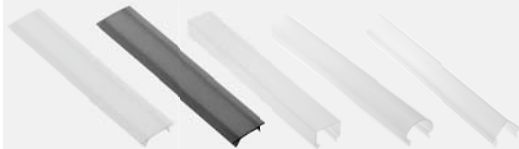

PA-OSMLGLAXM3M-00 PA-OSCLGLAXM3M-00 PA-OSMLGLAXMK3M-00 PA-OSMLGLAXM03M-00 PA-OSMLGLAXT3M-00

Zubehör / Accessoires / Accesorios:



PA-CPGLAXL-00 PA-CPGLAXAH-00 PA-CPGLAXAV-00



GLAX Wandprofil  
 Profilé GLAX mural  
 Perfil GLAX de pared

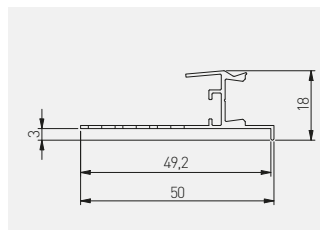
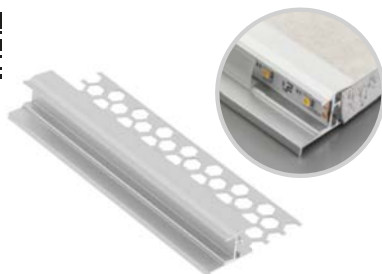

PA-GLAXGKS3M-00C	3		Profile, Profilé, Perfil		Aluminium, aluminium, aluminio
PA-CPGLAXL-00	–	Stecker gerade, connecteur linéaire, conector lineal		silberfarben, Argent, plata	rostfreier Stahl, Acier Inox, acero inoxidable
PA-CPGLAXAH-00	–	Anschluss horizontal, connecteur horizontal, conector horizontal			
PA-CPGLAXAV-00	–	Verbinder vertikal, connecteur vertical, conector vertical			
PA-OSMLGLAXM3M-00	3	Abdeckungen, protection, difusor		milchig, blanc dépoli, blanco mate	PC
PA-OSMLGLAXMK3M-00	3	quadratische Abdeckung, protection carrée, difusor cuadrada			
PA-OSMLGLAXM03M-00	3	Abdeckung rund, protection ronde, difusor redonda			
PA-OSMLGLAXT3M-00	3	dreieckige Abdeckung, protection triangulaire, difusor triangular			
PA-OSCLGLAXM3M-00	3	Abdeckung mini, protection mini, difusor mini		schwarz, noir, negro	

Abdeckungen / Protection / difusor:

Zubehör / Accessoires / Accesorios:

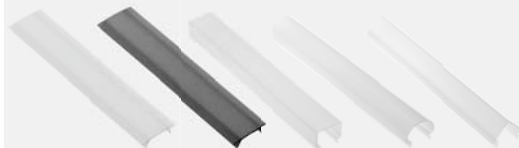

PA-CPGLAXL-00 PA-CPGLAXAH-00 PA-CPGLAXAV-00

PA-OSMLGLAXM3M-00 PA-OSCLGLAXM3M-00 PA-OSMLGLAXMK3M-00 PA-OSMLGLAXM03M-00 PA-OSMLGLAXT3M-00





DO  
*something*  
(today)  
THAT YOUR  
FUTURE SELF  
WILL  
THANK YOU  
for

BE  
BRAVE

the  
time  
is  
now.

Better  
days are  
coming.  
They're  
called  
Saturday and  
Sunday.

Smile  
you  
are  
beaut-  
iful.

DO  
WHAT  
YOU  
LOVE.

Al  
you  
is  
BRA



GLAX Deckenprofil  
 Profilé GLAX plafond  
 Perfil GLAX de techo

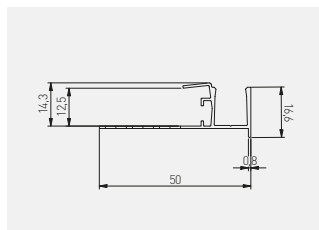
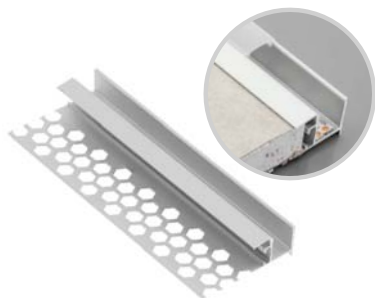

PA-GLAXGW3M-00C	3	Profile, Profilé, Perfil			Aluminium, aluminium, aluminio
PA-CPGLAXL-00	-	Stecker gerade, connecteur linéaire, conector lineal		silberfarben, Argent, plata	
PA-CPGLAXAH-00	-	Anschluss horizontal, connecteur horizontal, conector horizontal			rostfreier Stahl, Acier Inox, acero inoxidable
PA-CPGLAXAV-00	-	Verbinder vertikal, connecteur vertical, conector vertical			
PA-OSMLGLAXM3M-00	3	Abdeckungen, protection, difusor			
PA-OSMLGLAXMK3M-00	3	quadratische Abdeckung, protection carrée, difusor cuadrada		milchig, blanc dépoli, blanco mate	
PA-OSMLGLAXM03M-00	3	Abdeckung rund, protection ronde, difusor redonda			PC
PA-OSMLGLAXT3M-00	3	dreieckige Abdeckung, protection triangulaire, difusor triangular			
PA-OSCLGLAXM3M-00	3	Abdeckung mini, protection mini, difusor mini		schwarz, noir, negro	

Abdeckungen / Protection / difusor:

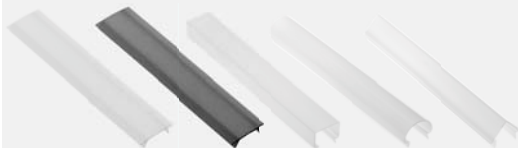

PA-OSMLGLAXM3M-00 PA-OSCLGLAXM3M-00 PA-OSMLGLAXMK3M-00 PA-OSMLGLAXM03M-00 PA-OSMLGLAXT3M-00

Zubehör / Accessoires / Accesorios:



PA-CPGLAXL-00 PA-CPGLAXAH-00 PA-CPGLAXAV-00





Winkelprofil GLAX, innen  
 Profilé d'angle GLAX interne  
 Perfil GLAX angular, interno

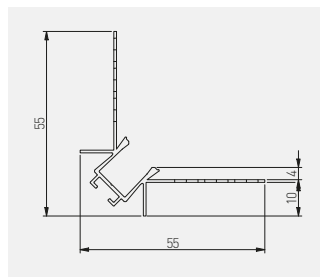

PA-GLAXGKWK3M-00C	3	Profile, Profilé, Perfil	silberfarben, Argent, plata	Aluminium, aluminium, aluminio
PA-CPGLAXL-00	-	Stecker gerade, connecteur linéaire, conector lineal		
PA-CPGLAXAH-00	-	Anschluss horizontal, connecteur horizontal, conector horizontal		
PA-CPGLAXAV-00	-	Verbinder vertikal, connecteur verical, conector vertical		
PA-OSMLGLAXM3M-00	3	Abdeckungen, protection, difusor	milchig, blanc dépoli, blanco mate	PC
PA-OSMLGLAXMK3M-00	3	quadratische Abdeckung, protection carrée, difusor cuadrada		
PA-OSMLGLAXM03M-00	3	Abdeckung rund, protection ronde, difusor redonda		
PA-OSMLGLAXT3M-00	3	dreieckige Abdeckung, protection triangulaire, difusor triangular		
PA-OSCLGLAXM3M-00	3	Abdeckung mini, protection mini, difusor mini	schwarz, noir, negro	

Abdeckungen / Protection / difusor:

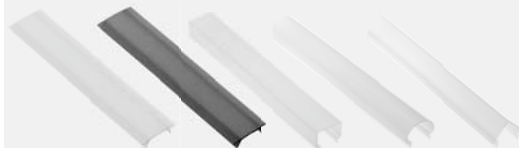

PA-OSMLGLAXM3M-00 PA-OSCLGLAXM3M-00 PA-OSMLGLAXMK3M-00 PA-OSMLGLAXM03M-00 PA-OSMLGLAXT3M-00

Zubehör / Accessoires / Accesorios:



PA-CPGLAXL-00 PA-CPGLAXAH-00 PA-CPGLAXAV-00



Winkelprofil GLAX, außen  
 Profilé d'angle GLAX externe  
 Perfil GLAX angular, externo

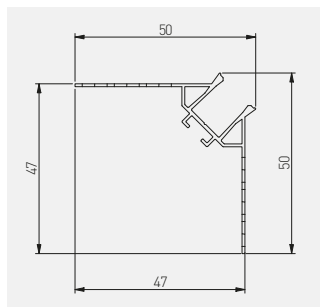
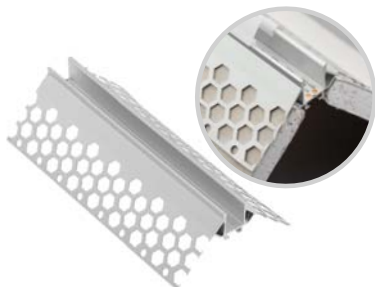

PA-GLAXGKZK3M-00C	3	m	Profile, Profilé, Perfil		Aluminium, aluminium, aluminio
PA-CPGLAXL-00	-		Stecker gerade, connecteur linéaire, conector lineal	silberfarben, Argent, plata	rostfreier Stahl, Acier Inox, acero inoxidable
PA-CPGLAXAH-00	-		Anschluss horizontal, connecteur horizontal, conector horizontal		
PA-CPGLAXAV-00	-		Verbinder vertikal, connecteur vertical, conector vertical		
PA-OSMLGLAXM3M-00	3		Abdeckungen, protection, difusor	milchig, blanc dépoli, blanco mate	PC
PA-OSMLGLAXMK3M-00	3		quadratische Abdeckung, protection carrée, difusor cuadrada		
PA-OSMLGLAXM03M-00	3		Abdeckung rund, protection ronde, difusor redonda		
PA-OSMLGLAXT3M-00	3		dreieckige Abdeckung, protection triangulaire, difusor triangular		
PA-OSCLGLAXM3M-00	3		Abdeckung mini, protection mini, difusor mini	schwarz, noir, negro	

Abdeckungen / Protection / difusor:

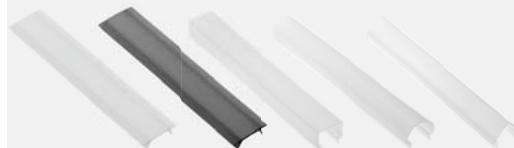

PA-OSMLGLAXM3M-00 PA-OSCLGLAXM3M-00 PA-OSMLGLAXMK3M-00 PA-OSMLGLAXM03M-00 PA-OSMLGLAXT3M-00

Zubehör / Accessoires / Accesorios:



PA-CPGLAXL-00 PA-CPGLAXAH-00 PA-CPGLAXAV-00

GLAX micro Aufsatzprofil  
 Profilé GLAX surface micro  
 Perfil GLAX de superficie micro

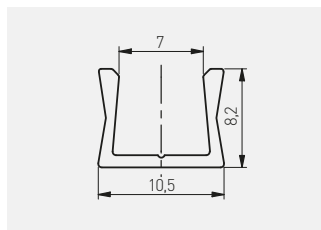
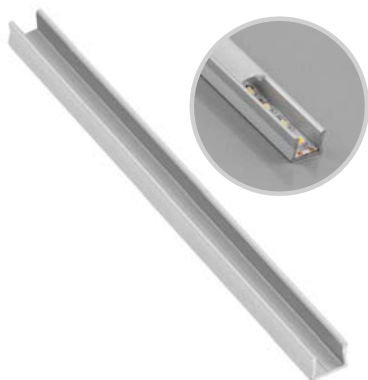

Schmale Lichtlinie. Keine Lichtpunkte bei Verwendung eines speziellen LED-Streifens mit einer Breite von 5 mm.,

Ligne de lumière étroite,  
 Aucun point d'éclairage lors de l'utilisation de la bande LED dédiée d'une largeur de 5 mm,  
 Línea de luz delgada,  
 Sin puntos de luz al utilizar una tira LED dedicada de anchura 5 mm

PA-GLAXMICNK-AL	2	Profile, Profilé, Perfil	silberfarben, Argent, plata	Aluminium, aluminium, aluminio
PA-GLAXMICNK3M-AL	3			
PA-OSMLGLAXMIC-00N	2	Abdeckung micro, protection micro, difusor micro	milchig, blanc dépoli, blanco mate	PC
PA-OSMLGLAXMIC3M-00N	3			
PA-ZASGLAXMICNK-00	-	Endkappen, bouchon d'extrémité, tapa lateral	grau, gris, gris	ABS
PA-SPRGLAXMIC-00	-	Montageclip, clip de fixation, soporte	silberfarben, Argent, plata	rostfreier Stahl, Acier Inox, acero inoxidable

Abdeckungen / Protection / difusor:



PA-OSMLGLAXMIC-00N  
 PA-OSMLGLAXMIC3M-00N

Endkappen / Bouchon d'extrémité / tapa  
 lateral:



PA-ZASGLAXMICNK-00

Montageclip /  
 Clip de fixation /  
 soporte:



PA-SPRGLAXMIC-00

GLAX mini Aufsatzprofil  
 Profilé GLAX surface mini  
 Perfil GLAX de superficie mini

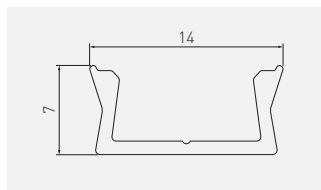

LED-Streifen max. 10 mm breit  
 Largeur de bande LED max 10 mm  
 Tira LED máx. 10 mm de anchura



PA-GLAXMNK-AL	2	Profile, Profilé, Perfil	silberfarben, Argent, plata	Aluminium, aluminium, aluminio						
PA-GLAXMNK-AL-20M			schwarz, noir, negro							
PA-GLAXMNK-AL-10			weiß, blanc, blanco							
PA-GLAXMNK-AL-90			Champagner, champagne, champán							
PA-GLAXMNK3M-AL	3	Profile, Profilé, Perfil	silberfarben, Argent, plata							
PA-GLAXMNK3M-AL-20M			schwarz, noir, negro							
PA-GLAXMNK3M-AL-10			weiß, blanc, blanco							
PA-OSMLGLAXM-00	2	Abdeckung mini, protection mini, difusor mini	milchig, blanc dépoli, blanco mate		PC					
PA-OSMLGLAXM3M-00			3			durchsichtig, translucide, transparente				
PA-OSTRGLAXM-00	2		Abdeckung mini, protection mini, difusor mini			schwarz, noir, negro				
PA-OSTRGLAXM3M-00							3			
PA-OSCLGLAXM-00	2					quadratische Abdeckung, protection carrée, difusor cuadrada	schwarz, noir, negro			
PA-OSCLGLAXM3M-00				3						
PA-OSMLGLAXM-00	2			Abdeckung rund, protection ronde, difusor redonda			milchig, blanc dépoli, blanco mate	ABS		
PA-OSMLGLAXM3M-00							3			
PA-ZASGLAXMNK-00	-						Standard-Endkappen, Cache standard, Tapa standard		grau / gris / gris	ABS
PA-ZASGLAXMNK-10									weiß, blanc, blanco	
PA-ZASGLAXMNK-90									Champagner, champagne, champán	
PA-ZASGLAXMNK-20M									schwarz matt, noir mat, negro mate	
PA-ZASGLAXMKNK-00	-	quadratische Endkappe, bouchon d'extrémité carré, tapa lateral cuadrado			grau / gris / gris					
PA-ZASGLAXMKNKO-00	-	runde Endkappe, bouchon d'extrémité rond, tapa lateral redondo			grau / gris / gris					
PA-SPRGLAXM-00	-	Montageclip, clip de fixation, soporte	silberfarben, Argent, plata		rostfreier Stahl, Acier Inox, acero inoxidable					

Abdeckungen /  
Protection / difusor:



PA-OSMLGLAXM-00  
PA-OSMLGLAXM3M-00



PA-OSTRGLAXM-00  
PA-OSTRGLAXM3M-00



PA-OSCLGLAXM-00  
PA-OSCLGLAXM3M-00



PA-OSMLGLAXM3M-00



PA-OSMLGLAXM-00

Endkappen / Bouchon  
d'extrémité / tapa lateral:



PA-ZASGLAXMNK-00



PA-ZASGLAXMKNK-00



PA-ZASGLAXMKNKO-00

Montageclip / Clip de fixation  
/ soporte:



PA-SPRGLAXM-00

GLAX Aufsatzprofil  
 Profilé GLAX surface  
 Perfil GLAX superficie

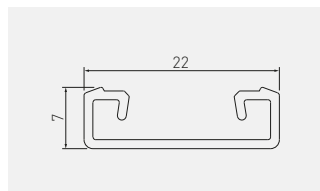

PA-GLAXNK-AL	2	Profile, Profilé, Perfil	silberfarben, Argent, plata	Aluminium, aluminium, aluminio
PA-GLAXNK3M-AL	3			
PA-OSMLGLAX-00	2	Abdeckung mini, protection mini, difusor mini	milchig, blanc dépoli, blanco mate	PC
PA-OSMLGLAX3M-00	3			
PA-OSTRGLAX-00	2		durchsichtig, translucide, transparente	
PA-OSTRGLAX3M-00	3			
PA-ZASGLAXNK-00	-	Endkappen, bouchon d'extrémité, tapa lateral	grau, gris, gris	ABS

Abdeckungen / Protection / difusor:



PA-OSMLGLAX-00  
 PA-OSMLGLAX3M-00

PA-OSTRGLAX-00  
 PA-OSTRGLAX3M-00

Endkappen / Bouchon d'extrémité / tapa lateral:



PA-ZASGLAXNK-00

Aufbauprofil GLAX mini, hoch  
 Profilé GLAX surface mini, haut  
 Perfil GLAX de superficie mini. alto

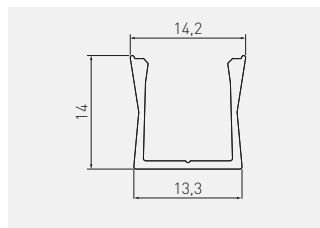

Keine sichtbaren Lichtpunkte  
 LED-Streifen max. 10 mm breit  
 Aucun point de lumière visible  
 Largeur de bande LED max 10 mm  
 Sin puntos de luz visibles  
 Tira LED máx. 10 mm de anchura



PA-GLAXMNKW-AL	2	Profile, Profilé, Perfil	silberfarben, Argent, plata	Aluminium, aluminium, aluminio
PA-GLAXMNKW-AL-20M			schwarz, noir, negro	
PA-GLAXMNKW-AL-10			weiß, blanc, blanco	
PA-GLAXMNKW-AL-90			Champagner, champagne, champán	
PA-OSMLGLAXM-00	2	Abdeckung mini, protection mini, difusor mini	milchig, blanc dépoli, blanco mate	PC
PA-OSTRGLAXM-00			durchsichtig, translucide, transparente	
PA-OSCLGLAXM-00			schwarz, noir, negro	
PA-ZASGLAXMNKW-00	-	Endkappen, bouchon d'extrémité, tapa lateral	grau, gris, gris	ABS
PA-ZASGLAXMNKW-10			weiß, blanc, blanco	
PA-ZASGLAXMNKW-90			Champagner, champagne, champán	
PA-ZASGLAXMNKW-20M			schwarz matt, noir mat, negro mate	
PA-SPRGLAXM-00	-	Montageclip, clip de fixation, soporte	silberfarben, Argent, plata	rostfreier Stahl, Acier Inox, acero inoxidable

Abdeckungen / Protection / difusor:

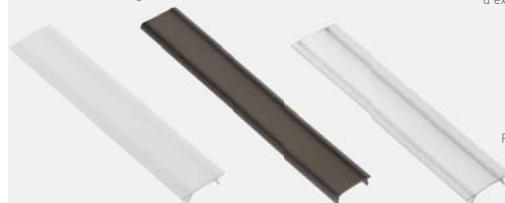

PA-OSMLGLAXM-00

PA-OSCLGLAXM-00

PA-OSTRGLAXM-00

Endkappen / Bouchon  
d'extrémité / tapa lateral:



PA-ZASGLAXMNKW-00

Montageclip / Clip de  
fixation / soporte:



PA-SPRGLAXM-00



Einlassprofil GLAX, hoch, micro  
 Profilé GLAX encastré micro  
 Perfil GLAX empotrable micro

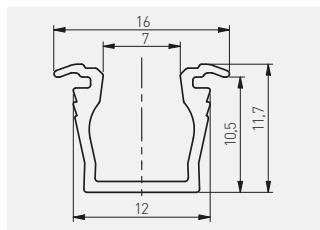

Schmale Lichtlinie. Keine Lichtpunkte bei Verwendung eines speziellen LED-Streifens mit einer Breite von 5 mm.

Ligne de lumière étroite,  
 Aucun point d'éclairage lors de l'utilisation de la bande LED dédiée d'une largeur 5 mm  
 Línea de luz delgada  
 Sin puntos de luz al utilizar una tira LED dedicada de anchura 5 mm

PA-GLAXMIC-AL	2	Profile, Profilé, Perfil	silberfarben, Argent, plata	Aluminium, aluminium, aluminio
PA-GLAXMIC3M-AL	3			
PA-OSMLGLAXMIC-00N	2	Abdeckung micro, protection micro, difusor micro	milchig, blanc dépoli, blanco mate	PC
PA-OSMLGLAXMIC3M-00N	3			
PA-ZASGLAXMIC-00	-	Endkappen, bouchon d'extrémité, tapa lateral	grau / gris / gris	ABS

Abdeckungen / Protection / difusor:



PA-OSMLGLAXMIC-00N  
 PA-OSMLGLAXMIC3M-00N

Endkappen / Bouchon d'extrémité / tapa lateral:



PA-ZASGLAXMIC-00

GLAX Einlassprofil  
 Profilé GLAX encastré  
 Perfil GLAX empotrable

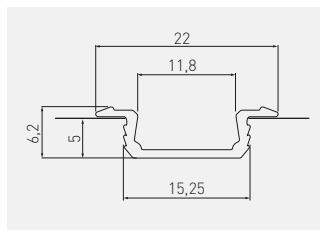

PA-GLAX-AL	2	Profile, Profilé, Perfit	silberfarben, Argent, plata	Aluminium, aluminio, aluminio	
PA-GLAX-AL-20M			schwarz, noir, negro		
PA-GLAX-AL-10			weiß, blanc, blanco		
PA-GLAX-AL-90			Champagner, champagne, champán		
PA-GLAX3M-AL	3	Profile, Profilé, Perfit	silberfarben, Argent, plata		
PA-GLAX3M-AL-20M			schwarz, noir, negro		
PA-GLAX3M-AL-10			weiß, blanc, blanco		
PA-OSMLGLAX-00	2	Abdeckungen, protection, difusor	milchig, blanc dépoli, blanco mate		PC
PA-OSMLGLAX3M-00	3		durchsichtig, translucide, transparente		
PA-OSTRGLAX-00	2		schwarz, noir, negro		
PA-OSTRGLAX3M-00	3				
PA-OSCLGLAX-00	2				
PA-OSCLGLAX3M-00	3				
PA-ZASGLAX-00	-	Endkappen, bouchon d'extrémité, tapa lateral	grau, gris, gris	ABS	
PA-ZASGLAX-10			weiß, blanc, blanco		
PA-ZASGLAX-90			Champagner, champagne, champán		
PA-ZASGLAX-20M			schwarz matt, noir mat, negro mate		

Abdeckungen / Protection / difusor:

Endkappen / Bouchon d'extrémité / tapa lateral:



PA-OSMLGLAX-00  
 PA-OSMLGLAX3M-00

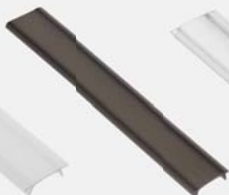

PA-OSCLGLAX-00



PA-OSTRGLAX-00  
 PA-OSTRGLAX3M-00



PA-ZASGLAX-00

Einlassprofil GLAX, hoch  
 Profilé GLAX encastré, haut  
 Perfil GLAX empotrable, alto

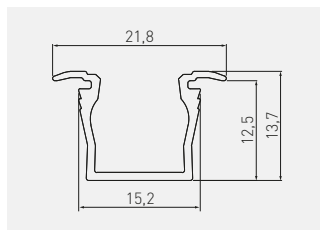

Keine sichtbaren Lichtpunkte  
 LED-Streifen max. 10 mm breit  
 Aucun point de lumière visible  
 Largeur de bande LED max 10 mm  
 Sin puntos de luz visibles  
 Tira LED máx. 10 mm de anchura

PA-GLAXMW-AL	2	Profile, Profilé, Perfil	silberfarben, Argent, plata		Aluminium, aluminium, aluminio
PA-GLAXMW-AL-20M			schwarz, noir, negro		
PA-GLAXMW-AL-10			weiß, blanc, blanco		
PA-GLAXMW-AL-90			Champagner, champagne, champán		
PA-OSCLGLAXM-00	2	Abdeckung mini, protection mini, difusor mini	schwarz, noir, negro		PC
PA-OSMLGLAXM-00		quadratische Abdeckung, protection carrée, difusor cuadrada	milchig, blanc dépoli, blanco mate		
PA-OSMLGLAXMK-00		Abdeckung mini, protection mini, difusor mini	durchsichtig, translucide, transparente		
PA-OSTRGLAXM-00	-	Standard-Endkappen, Cache standard, Tapa standard	grau, gris, gris		ABS
PA-ZASGLAXMW-00			weiß, blanc, blanco		
PA-ZASGLAXMW-10			Champagner, champagne, champán		
PA-ZASGLAXMW-90			schwarz matt, noir mat, negro mate		
PA-ZASGLAXMW-20M					
PA-ZASGLAXMWK-00	-	quadratische Endkappe, bouchon d'extrémité carré, tapa lateral cuadrado	grau, gris, gris		

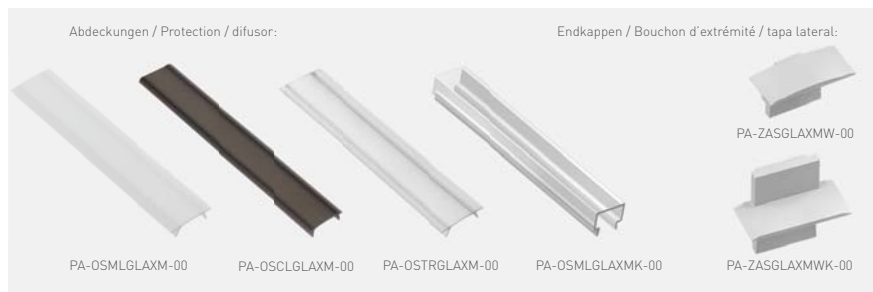

Kleiderstangenprofil GLAX  
 Profilé GLAX LED de penderie  
 Perfil-Barra GLAX

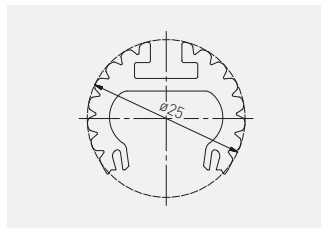

Befestigungsmöglichkeiten als  
 Options d'assemblage comme  
 Posibilidad de montaje como

- Kleiderstange
- Hängeleuchte
- tige dans le placard
- luminaire suspendu
- barra en el armario
- luminaria suspendida

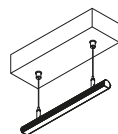
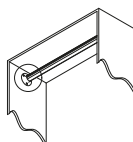

PA-GLAXDR-AL		Profile, Profilé, Perfil	silberfarben, Argent, plata	Aluminium, aluminium, aluminio
PA-OSMLGLAX-00	2	Abdeckungen, protection, difusor	milchig, blanc dépoli, blanco mate	PC
PA-OSTRGLAX-00			durchsichtig, translucide, transparente	
PA-ZASGLAXDR-00	-	Endkappen, bouchon d'extrémité, tapa lateral	grau, gris, gris	ZnAl
PA-ROZGLAX-53	-	Rosette, support rail, Roseta		
PA-ROZGLAXP-53	-	RoseTTE PREMIUM, support rail PREMIUM, RosetA PREMIUM		
PA-ZAWGLAXDR-00	1,5	Aufhängung, pendentif, colgador	Chrom, chrome, cromado	Stahl, acier, acero

Abdeckungen / Protection / difusor:



PA-OSMLGLAX-00

PA-OSTRGLAX-00

Endkappen / Bouchon d'extrémité / tapa lateral:



PA-ZASGLAXDR-00

Rosette / Support rail / Roseta:



PA-ROZGLAX-53

PA-ROZGLAXP-53

Aufhänger / Pendentif / colgador:





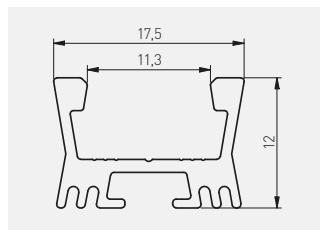

PA-ZAWGLAXDR-00

Profil GLAX mit Kühler  
 Profilé GLAX avec radiateur  
 Perfil GLAX con radiador



Spezielle Linse, die den Abstrahlwinkel auf 60° verengt.  
 Möglichkeit zum Aufhängen der Leuchte mit Seilen.  
 Lentille dédiée qui réduit l'angle de faisceau à 60 degrés  
 Possibilité de suspendre le montage à l'aide de lignes  
 Linde dedicada que aumenta el ángulo de apertura hasta los 60°  
 Posibilidad de suspender la luminaria mediante cables

				
PA-GLAXRAD-AL	2	Profile, Profilé, Perfil	silberfarben, Argent, plata	Aluminium, aluminium, aluminio
PA-OSMLGLAXSO-00	2	Linienabdeckung, protection lentille, protector de la lente	durchsichtig, translucide, transparente	PMMA
PA-OSMLGLAX-00	2	Abdeckungen, protection, difusor	milchig, blanc dépoli, blanco mate	PC
PA-OSTRGLAX-00			durchsichtig, translucide, transparente	
PA-ZASGLAXRAD-00	-	Endkappen, bouchon d'extrémité, tapa lateral	grau, gris, gris	ABS
PA-ZAWGLAXDR-00	1,5	Aufhängung, pendentif, colgador	Chrom, chrome, cromado	Stahl, acier, acero
PA-SPRGLAXM-00	-	Montageclip, clip de fixation, soporte	silberfarben, Argent, plata	rostfreier Stahl, Acier Inox, acero inoxidable



Schrankunterbodenprofil GLAX  
 Profilé GLAX avec radiateur  
 Perfil GLAX con radiador

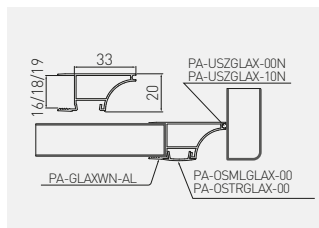

PA-GLAXWN-AL	18	2	Profile, Profilé, Perfil	silberfarben, Argent, plata	Aluminium, aluminium, aluminio
PA-GLAXWN3M-AL		3		schwarz, noir, negro	
PA-GLAXWN3M-AL-20M				weiß, blanc, blanco	
PA-GLAXWN3M-AL-10				inox, inox, inox	
PA-GLAXWN3M-AL-06					
PA-GLAXWN16-AL	16	2		silberfarben, Argent, plata	
PA-GLAXWN19-AL	19				
PA-OSMLGLAX-00	-	2	Abdeckungen, protection, difusor	milchig, blanc dépoli, blanco mate	PC
PA-OSTRGLAX-00	-			durchsichtig, translucide, transparente	
PA-OSCLGLAX-00	-			schwarz, noir, negro	
PA-OSMLGLAX3M-00	-	3		milchig, blanc dépoli, blanco mate	
PA-OSTRGLAX3M-00	-			durchsichtig, translucide, transparente	
PA-OSCLGLAX3M-00	-			schwarz, noir, negro	
PA-USZGLAX-00N	-	10	Dichtung, Joint d'étanchéité, junta	schwarz, noir, negro	EPDM
PA-USZGLAX-10N	-			weiß, blanc, blanco	

Abdeckungen / Protection / difusor:

Dichtung / Joint d'étanchéité / junta:



PA-OSMLGLAX-00  
PA-OSMLGLAX3M-00

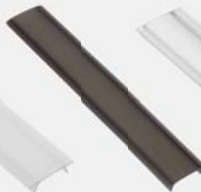

PA-OSCLGLAX-00  
PA-OSCLGLAX3M-00



PA-OSTRGLAX-00



ø2,5

ø2,5

PA-USZGLAX-00N

PA-USZGLAX-10N

Aufbau-Winkelprofil GLAX  
 Profilé d'angle GLAX, surface  
 Perfil GLAX angular, de superficie

meble  
 2019 plus  
 PRODUKT ROKU

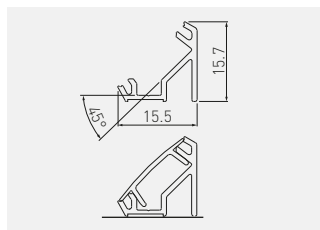

PA-GLAXNKKT-AL	2	Profile, Profilé, Perfil	silberfarben, Argent, plata	Aluminium, aluminium, aluminio
PA-GLAXNKKT-AL-20M			schwarz, noir, negro	
PA-GLAXNKKT-AL-10			weiß, blanc, blanco	
PA-GLAXNKKT-AL-90			Champagner, champagne, champán	
PA-GLAXNKKT3M-AL	3	Profile, Profilé, Perfil	silberfarben, Argent, plata	
PA-GLAXNKKT3M-AL-20M			schwarz, noir, negro	
PA-GLAXNKKT3M-AL-10			weiß, blanc, blanco	
PA-OSMLGLAX-00	2	Abdeckungen, protection, difusor	milchig, blanc dépoli, blanco mate	
PA-OSMLGLAX3M-00	3		durchsichtig, translucide, transparente	
PA-OSTRGLAX-00	2		schwarz, noir, negro	
PA-OSTRGLAX3M-00	3			
PA-OSCLGLAX-00	2			
PA-OSCLGLAX3M-00	3		schwarz, noir, negro	
PA-OSMLGLAXT-00	2	dreieckige Abdeckung, protection triangulaire, difusor triangular	milchig, blanc dépoli, blanco mate	
PA-ZASGLAXNKKT-00	-	Standard-Endkappen, Cache standard, Tapa standard	grau, gris, gris	ABS
PA-ZASGLAXNKKT-10			weiß, blanc, blanco	
PA-ZASGLAXNKKT-90			Champagner, champagne, champán	
PA-ZASGLAXNKKT-20M			schwarz matt, noir mat, negro mate	
PA-ZASGLAXNKKT-00	-	dreieckige Endkappen, bouchon d'extrémité triangulaire, tapa lateral triangular	grau, gris, gris	
PA-SPRGLAXMIC-00	-	Montageclip, clip de fixation, soporte	silberfarben, Argent, plata	rostfreier Stahl, Acier Inox, acero inoxidable

Abdeckungen / Protection / difusor:

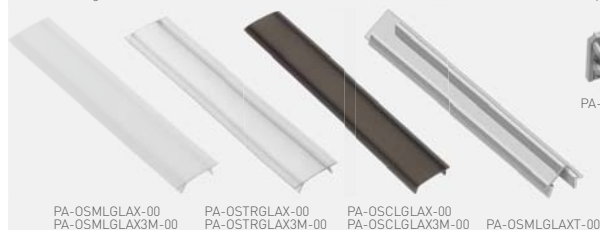

Endkappen / Bouchon d'extrémité / tapa lateral:









Montageclip / Clip de  
 fixation / soporte:

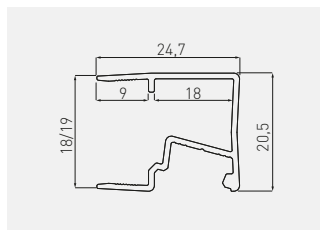

PA-SPRGLAXMIC-00

Sockelprofil GLAX, einseitig, schmal  
 Profilé GLAX pour base étroit, 1 face  
 Perfil GLAX de corona, estrecho una sola cara



		 BOARD mm	 L m			
PA-GLAXMNB JW3M-AL		18	3	Profile, Profilé, Perfil	silberfarben, Argent, plata	Aluminium, aluminium, aluminio
PA-GLAXMNB JW3M19-AL		19				
PA-OSMLGLAXM3M-00		-		Abdeckungen, protection, difusor	milchig, blanc dépoli, blanco mate	PC
PA-OSTRGLAXM3M-00		-				

Abdeckungen / Protection / difusor:



PA-OSMLGLAXM3M-00







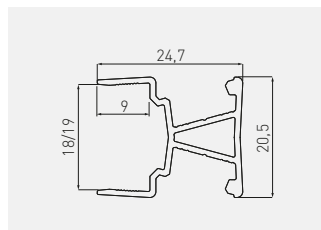
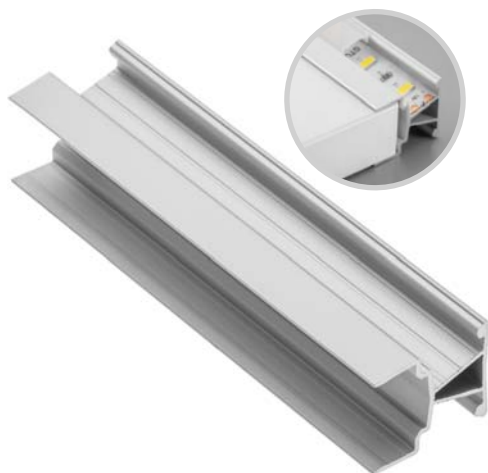

PA-OSTRGLAXM3M-00



Sockelprofil GLAX, doppelseitig, schmal  
 Profilé GLAX pour base étroite, 2 face  
 Perfil GLAX de corona, estrecho doble sola cara



		 BOARD mm	 L mm			
PA-GLAXMNBW3M-AL		18	3	Profile, Profilé, Perfil	silberfarben, Argent, plata	Aluminium, aluminium, aluminio
PA-GLAXMNBW3M19-AL		19				
PA-OSMLGLAXM3M-00		-		Abdeckung mini, protection mini, difusor mini	blanc dépoli, blanco mate, milchig,	PC
PA-OSTRGLAXM3M-00		-			durchsichtig, translucide, transparente	

Abdeckungen / Protection / difusor:



PA-OSMLGLAXM3M-00







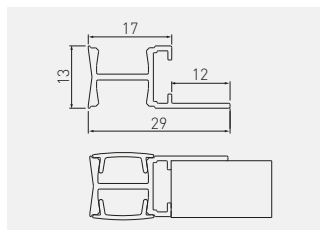

PA-OSTRGLAXM3M-00

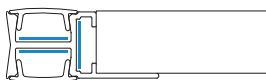
Profi L GLAX mini für Glaskantenbeleuchtung  
 Profilé GLAX mini  
 Perfil GLAX para mini anaquel



Einsatzmöglichkeit von 3 LED-Streifen  
 Possibilité d'utiliser 3 bandes LED  
 Posibilidad de emplear 3 tiras LED



				
PA-GLAXMPIK-AL	2	Profile, Profilé, Perfil	silberfarben, Argent, plata	Aluminium, aluminium, aluminio
PA-OSMLGLAXM-00		Abdeckung mini, protection mini, difusor mini	milchig, blanc dépoli, blanco mate	PC
PA-OSTRGLAXM-00			durchsichtig, transLucide, transparente	

Abdeckungen / Protection / difusor:









PA-OSMLGLAXM-00

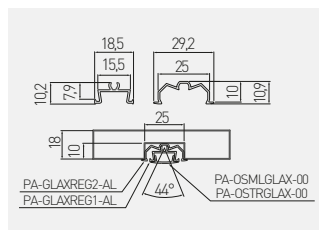

PA-OSTRGLAXM-00

GLAX Profil, Leuchtwinkel einstellbar  
 Profilé GLAX avec angle réglable de lumière  
 Perfil GLAX con regulación de ángulo de iluminación



	 L m			
PA-GLAXREG1-AL	2	Profilé, Profilé, Perfil	silberfarben, Argent, plata	Aluminium, aluminium, aluminio
PA-GLAXREG2-AL				
PA-OSMLGLAX-00	2	Abdeckung mini, protection mini, difusor mini	milchig, blanc dépoli, blanco mate	PC
PA-OSTRGLAX-00			durchsichtig, translucide, transparente	

Abdeckungen / Protection / difusor:









PA-OSMLGLAX-00

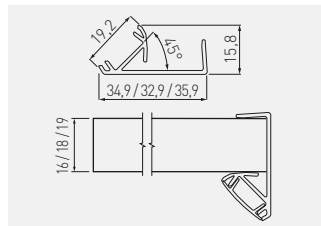

PA-OSTRGLAX-00

Sockelprofil GLAX, einseitig  
 Profilé GLAX pour base 1 face  
 Perfil GLAX de zócalo, unilateral



	 BOARD mm	 L m			
PA-GLAXNBJ3M16-AL	16	3	Profile, Profilé, Perfil	silberfarben, Argent, plata	Aluminium, aluminium, aluminio
PA-GLAXNBJ3M-AL	18	3			
PA-GLAXNBJ3M19-AL	19	3			
PA-OSMLGLAX3M-00	-	3	Abdeckungen, protection, difusor	milchig, blanc dépoli, blanco mate	PC
PA-OSTRGLAX3M-00	-	3		durchsichtig, translucide, transparente	

Abdeckungen / Protection / difusor:









PA-OSMLGLAX3M-00

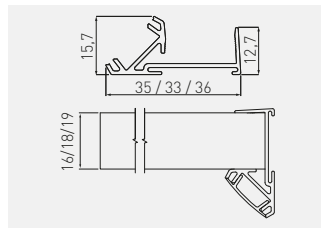

PA-OSTRGLAX3M-00

Sockelprofil GLAX, einseitig, mit Platz für Randstreifen  
 Profilé GLAX base 1 face, à remplir avec une bordure  
 Perfil GLAX de zócalo, unilateral, cubre cantos



	 BOARD mm	 L mm m			
PA-GLAXNB JW3M16-AL	16	3	Profile, Profilé, Perfil	silberfarben, Argent, plata	Aluminium, aluminium, aluminio
PA-GLAXNB JW3M-AL	18	3			
PA-GLAXNB JW3M19-AL	19	3			
PA-OSMLGLAX3M-00	-	3	Abdeckungen, protection, difusor	milchig, blanc dépoli, blanco mate	PC
PA-OSTRGLAX3M-00	-	3		durchsichtig, translucide, transparente	

Abdeckungen / Protection / difusor:









PA-OSMLGLAX3M-00

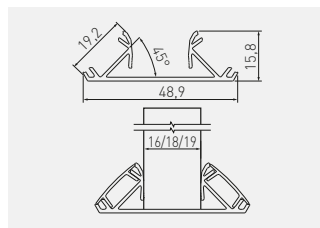

PA-OSTRGLAX3M-00

Sockelprofil GLAX, einseitig, mit Platz für Randstreifen  
 Profilé GLAX cloison, 2 faces  
 Perfil GLAX para separaciones, doble



	 BOARD mm	 L m			
PA-GLAXNBD3M16-AL	16	3	Profile, Profilé, Perfil	silberfarben, Argent, plata	Aluminium, aluminium, aluminio
PA-GLAXNBD3M-AL	18	3			
PA-GLAXNBD3M19-AL	19	3			
PA-OSMLGLAX3M-00	-	3	Abdeckungen, protection, difusor	milchig, blanc dépoli, blanco mate	PC
PA-OSTRGLAX3M-00	-	3		durchsichtig, translucide, transparente	

Abdeckungen / Protection / difusor:









PA-OSMLGLAX3M-00

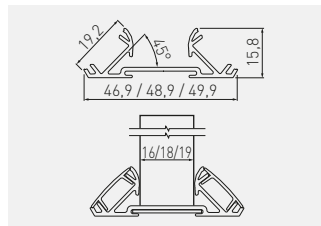

PA-OSTRGLAX3M-00

Trennprofil GLAX, doppelseitig, mit Platz für Randstreifen  
 Profilé GLAX cloison, 2 faces, à remplir avec une bordure  
 Perfil GLAX para separaciones, doble, cubre cantos



	 BOARD mm	 L m			
PA-GLAXNBDW3M16-AL	16	3	Profile, Profilé, Perfil	silberfarben, Argent, plata	Aluminium, aluminium, aluminio
PA-GLAXNBDW3M-AL	18	3			
PA-GLAXNBDW3M19-AL	19	3			
PA-OSMLGLAX3M-00	-	3	Abdeckungen, protection, difusor	mitchig, blanc dépoli, blanco mate	PC
PA-OSTRGLAX3M-00	-			durchsichtig, translucide, transparente	

Abdeckungen / Protection / difusor:







PA-OSMLGLAX3M-00

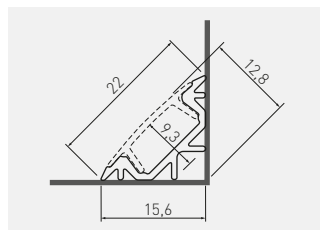

PA-OSTRGLAX3M-00

Winkelprofil GLAX  
 Profilé GLAX d'angle pour ruban LED  
 Perfil GLAX angular



	 L m			
PA-GLAXKT-AL	2	Profile, Profilé, Perfil	silberfarben, Argent, plata	Aluminium, aluminium, aluminio
PA-GLAXKT3M-AL	3			
PA-OSMLGLAX-00	2	Abdeckungen, protection, difusor	milchig, blanc dépoli, blanco mate	PC
PA-OSMLGLAX3M-00	3			
PA-OSTRGLAX-00	3		durchsichtig, translucide, transparente	
PA-OSTRGLAX3M-00	2			
PA-ZASGLAXKT-00	-	Endkappen, bouchon d'extrémité, tapa lateral	grau, gris, gris	ABS

Abdeckungen / Protection / difusor:



PA-OSMLGLAX-00  
 PA-OSMLGLAX3M-00

PA-OSTRGLAX-00  
 PA-OSTRGLAX3M-00

Endkappen / Bouchon d'extrémité / tapa lateral:



PA-ZASGLAXKT-00



Einlass-Winkelprofil GLAX  
 Profilé GLAX coudé, encastré  
 Perfil GLAX angular, empotrable

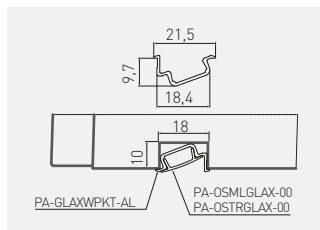

Strahlungswinkel 22°  
 Angle de faisceau 22°  
 Ángulo de iluminación 22°



PA-GLAXWPKT-AL	2	Profile, Profilé, Perfil	silberfarben, Argent, plata	Aluminium, aluminium, aluminio
PA-OSMLGLAX-00		Abdeckungen, protection, difusor	milchig, blanc dépoli, blanco mate	PC
PA-OSTRGLAX-00			durchsichtig, translucide, transparente	

Abdeckungen / Protection / difusor:



PA-OSMLGLAX-00



PA-OSTRGLAX-00

Einlassprofilset GLAX  
 Ensemble de profilé GLAX encastré  
 Conjunto de perfil GLAX empotrable

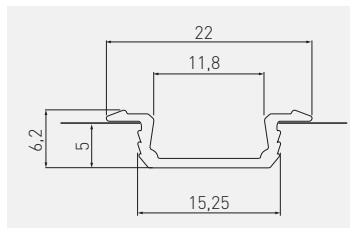

			
PA-ZGLAXOMZ-00	2	silberfarben, Argent, plata	Aluminium, PC milchig, ABS; aluminium, PC blanc dépoli, ABS; aluminio, PC blanco mate, ABS
PA-ZGLAXOMZ-20M		schwarz, noir, negro	
PA-ZGLAXOMZ-10		weiß, blanc, blanco	

Aufbauprofilset GLAX mini  
 Ensemble de profilé GLAX surface mini  
 Conjunto de perfil GLAX de superficie mini

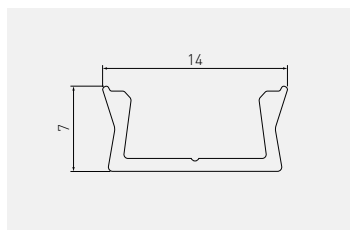

Montageclip / Clip de fixation / soporte:



			
PA-ZGLAXMNKOMZ-00	2	silberfarben, Argent, plata	Aluminium, PC milchig, ABS; aluminium, PC blanc dépoli, ABS; aluminio, PC blanco mate, ABS
PA-ZGLAXMNKOMZ-20M		schwarz, noir, negro	
PA-ZGLAXMNKOMZ-10		weiß, blanc, blanco	

Winkelprofilset GLAX  
 Ensemble de profilé GLAX surface mini  
 Conjunto de perfil GLAX de superficie mini

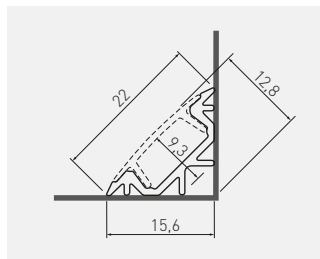

PA-ZGLAXKTMZ-00



2



silberfarben, Argent, plata



Aluminium, PC milchig, ABS;  
 aluminium, PC blanc dépoli, ABS;  
 aluminio, PC blanco mate, ABS

Aufbau-Winkelprofil GLAX  
 Profilé d'angle GLAX, surface  
 Perfil GLAX angular, de superficie

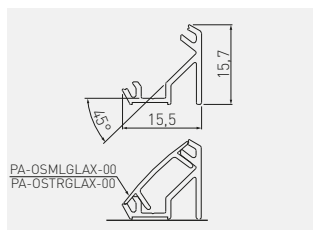

PA-ZGLAXNKKTOMZ-20M

PA-ZGLAXNKKTOMZ-10



2



schwarz, noir, negro

weiß, blanc, blanco



Aluminium, PC milchig, ABS;  
 aluminium, PC blanc dépoli, ABS;  
 aluminio, PC blanco mate, ABS

Auf- bzw. Einbauleuchte  
Luminaire appliqué / encastré  
Foco de superficie / empotrable

## VASCO

360°

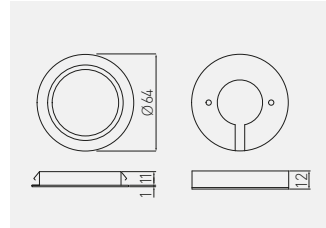

LD-VA24CB-53	130 lm	● 3000 K	Aluminium, aluminium, aluminio	Kunststoff, Plastique, plastico
LD-VA24NE-53		● 4000 K		



LED-Leuchte  
Luminaire LED  
Luminaria LED

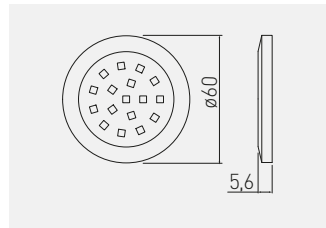







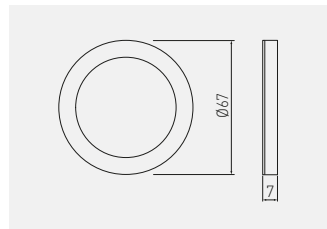

LD-LU16CB-53	85 lm	● 2700 K	Aluminium, aluminium, aluminio	Kunststoff, Plastique, plastico
LD-LU16NE-53		● 4000 K		
LD-LU16ZB-53		● 6500 K		





LED Aufbauleuchte mit Schalter  
 Luminaire avec interrupteur LED  
 Foco con interruptor LED



				
LD-CS36CB-53	180 lm	 3000 K	Aluminium, aluminium, aluminio	Kunststoff, Plastico, plastico
LD-CS36NE-53		 4000 K		
LD-CS36ZB-53		 6200 K		



LED-Einbauleuchte  
Luminaire encastré LED  
Foco empotrable LED

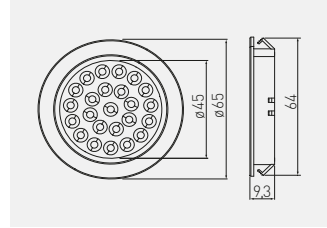

LD-AL24CB-53	130 lm	3000 K	Aluminium, aluminium, aluminio	Kunststoff, Plastique, plástico
LD-AL24NE-53		4000 K		
LD-AL24ZB-53		6400 K		



LED-Leuchte  
Luminaire LED  
Luminaria LED

## VEGAS

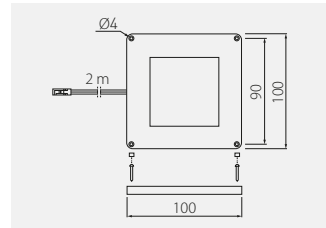

LD-VE15CB-53N	140 lm	3000 K	Aluminium, aluminium, aluminio	Aluminium + Kunststoff, aluminium + Plastique aluminio + plástico
LD-VE15NE-53N	145 lm	4000 K		
LD-VE15ZB-53N	150 lm	6400 K		



## Aufbauleuchte 2-in-1

### Luminaire 2 en 1

### Foco 2 en 1

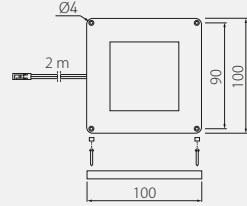

Verwandte Produkte:  
Kabelloser Berührungsschalter CCT  
AE-WDBP2CCT-10N, AE-WDBP2CCT-20N  
Produits connexes:  
Interrupteur sans contact sans fil CCT  
AE-WDBP2CCT-10N, AE-WDBP2CCT-20N  
Productos relacionados:  
Interruptor táctil inalámbrico CCT  
AE-WDBP2CCT-10N, AE-WDBP2CCT-20N



LD-VE15CBZB-53N	140 lm	● 3000 K - ● 6400 K	Aluminium, aluminium, aluminio	Aluminium + Kunststoff, aluminium + Plastique, aluminio + plastico
-----------------	--------	---------------------	--------------------------------------	--



## LED-Leuchte

### Luminaire LED

### Luminaria LED

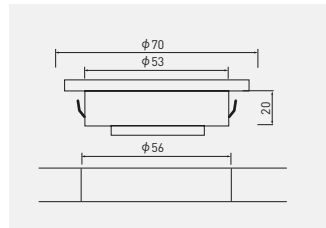

LD-TR24CB-53	300 lm	● 3000 K	Aluminium, aluminium, aluminio	Kunststoff, Plastique, plastico
LD-TR24NE-53	220 lm	● 4000 K		
LD-TR24ZB-53	300 lm	● 6400 K		



Leuchtensatz mit Schalter  
 Kit de luminaires avec interrupteur  
 Conjunto de luminarias con interruptor

## CASTELLO

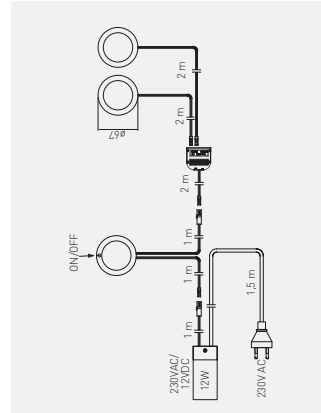

LD-Z3CSCB-53	3 x 180 lm	● 8000 K	Aluminium, aluminium, aluminio	Kunststoff, Plastique, plastico



Leuchtenset  
 Ensemble de luminaires  
 Conjunto de focos

## BARRI

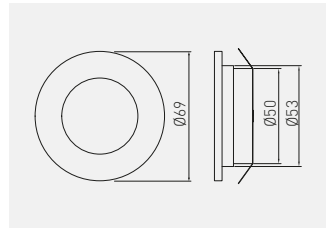

LD-OBP27CB-53	3 x 80 lm	● 2700 K	Aluminium, aluminium, aluminio	Aluminium + Kunststoff, aluminium + Plastique, aluminio + plastico
LD-OBP27ZB-53		● 6400 K		





Leuchtenset  
Ensemble de luminaires  
Conjunto de focos

## MARBELLA

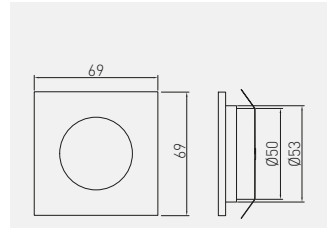

LD-KWP27CB-53	3 x 80 lm	2700 K	Aluminium, aluminium, aluminio	Aluminium + Kunststoff, aluminium + Plastique, aluminio + plastico



Schrankaufbauleuchte  
Luminaire sur bras  
Luminaria para muebles altos

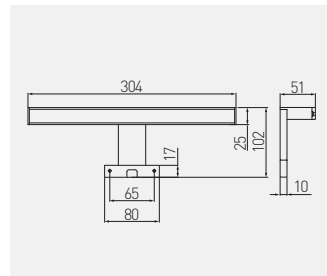

LD-RA60CB-40N	220 lm	3000 K	Chrom, chrome, cromado	Kunststoff, Plastique, plastico
LD-RA60ZB-40N		6000 K		



Kabellose LED-Leuchte  
Luminaire LED sans fil  
Luminaria LED inalámbrica



LD-IRUSB-53



LD-PIRUSB-53

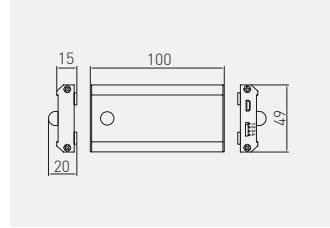

LD-IRUSB-53				Näherungsschalter IR (2 Funktionen: Bewegungsschalter und Schranktür-Schalter) Capteur de proximité IR, 1 ou 2 pôles Detector de proximidad IR, simple o doble	Aluminium, aluminium, aluminio	Stahl + Kunststoff, acier + Plastique, acero + plástico
LD-PIRUSB-53	40-50 lm	4000 K	Bewegungs- und Präsenzsensoren PIR Schranktür-Schalter Capteur de proximité IR, 1 pôle Detector de movimiento PIR, simple			

Lämpchen  
Lampe  
Lámpara

360°

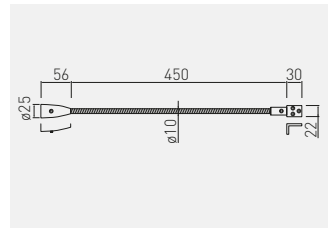

Netzteil 12 V, 6 W erforderlich  
Nécessite alimentation 12 V, 6 W  
Require adaptador de 12 V, 6 W

LD-BOS1CBWG-53		90 lm	3000 K	Aluminium, aluminium, aluminio	Aluminium + Stahl + Kunststoff, aluminium + acier + Plastique, aluminio + acero + plástico	

LED-Clip  
Clip d'étagère pour LED  
Klipsy LED do półek

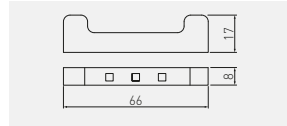
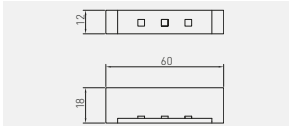

LD-KLPCB-00N LD-KLPNB-00N LD-KLPZB-00N

LD-3SKL-ZBN

LD-KLPCB-00N	10 lm	● 3000 K	Kunststoff, Plastique, plástico
LD-KLPNB-00N	-	blau, bleu, azul	
LD-KLPZB-00N	12 lm	● 6400 K	
LD-3SKL-ZBN	12 lm	● 6400 K	Stahl, acier, acero,



LED-Netzteile EASY CLICK  
Alimentation LED EASY CLICK  
Fuente de alimentación LED EASY CLICK

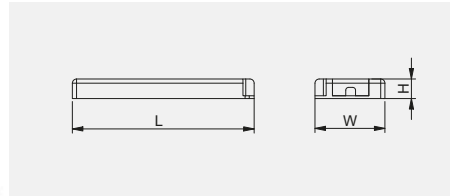





LD-ZAS09WEC-30	9 W	3 miniAMP	0,75 A	103 x 41 x 12mm	Kunststoff, Plastique, plástico	110 g
LD-ZAS15WEC-30	15 W	4 miniAMP	1,25 A	129 x 42 x 16 mm		130 g
LD-ZAS20WEC-30	20 W		1,67 A	129 x 42 x 16 mm		140 g
LD-ZAS30WEC-30	30 W	6 miniAMP	2,5 A	160 x 50 x 18 mm		190 g
LD-ZAS60WEC-30	60 W		5 A	190 x 62 x 21 mm		290 g

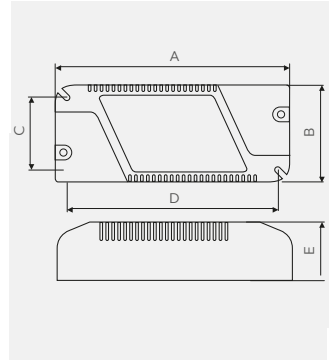

LED-Netzteile  
Alimentation LED  
Fuente de alimentación LED







				
LD-ZAS75W-30	max 75 W	180 x 52 x 42 x 176 x 30	Kunststoff, Plastique, plastico	350 g

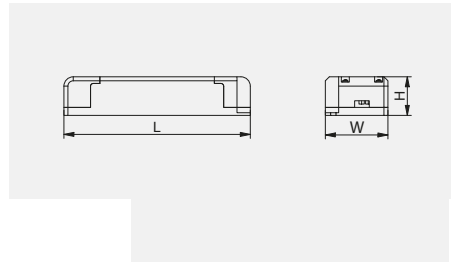

LED-Netzteile 24 V  
Alimentation LED 24V  
Fuente de alimentación LED 24V



				
LD-ZAS24PRO80W-30	80 W	181 x 63 x 40 mm	Kunststoff, Plastique, plastico	300 g
LD-ZAS24PRO16W-30	16 W			
LD-ZAS24PRO33W-30	33 W			
LD-ZAS24PRO54W-30	54 W			



Stromversorgungssystem  
Système d'alimentation  
Sistema de alimentación



LD-ZZAS07PROKD6	7 W	100 x 39 x 25	Kunststoff, Plastique, plastico
LD-ZZAS12PROKD6	12 W	120 x 42 x 27	
LD-ZZAS16PROKD6	16 W	120 x 42 x 27	
LD-ZZAS24PROKD6	24 W	140 x 47 x 29	
LD-ZZAS33PROKD6	33 W	155 x 53 x 30	

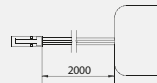
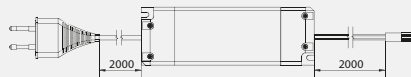
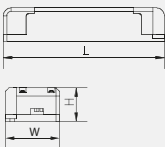

LED PRO-Netzteile  
Alimentation LED PRO  
Fuente de alimentación LED PRO

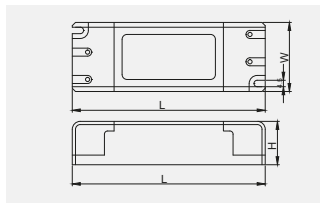

LD-ZASPRO07W-30	7 W	100 x 39 x 25 mm	Kunststoff, Plastique, plástico	56g
LD-ZASPRO12W-30	12 W	120 x 42 x 27 mm		82 g
LD-ZASPRO14W-30	16 W	120 x 42 x 27 mm		82 g
LD-ZASPRO24W-30	24 W	140 x 47 x 29 mm		109 g
LD-ZASPRO33W-30	33 W	140 x 47 x 29 mm		150 g
LD-ZASPRO54W-30	54 W	155 x 53 x 30 mm		173 g
LD-ZASPRO65W-30	65 W	181 x 63 x 40 mm		281 g
LD-ZASPRO80W-30	80 W	181 x 63 x 40 mm		290g



LED-Netzteile  
Alimentation LED  
Fuente de alimentación LED

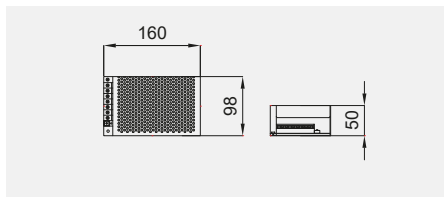

LD-ZAS150-NW	max 150 W	160 x 98 x 50	Aluminium, aluminium, aluminio	347 g
--------------	-----------	---------------	--------------------------------	-------



LED-Netzteile  
Alimentation LED  
Fuente de alimentación LED

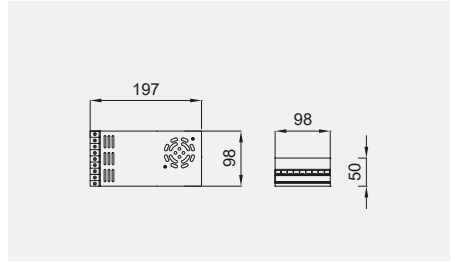

LD-ZAS350-NW	max 350 W	197 x 98 x 50	Aluminium, aluminium, aluminio	589 g



LED-Netzteile  
Alimentation LED  
Fuente de alimentación LED



LD-WZA20W-NW	20 W	170 g
LD-WZA36W-NW	36 W	310 g
LD-WZA60W-NW	60 W	990 g
LD-WZA80W-NW	80 W	1000 g
LD-WZA150W-NW	150 W	2000 g

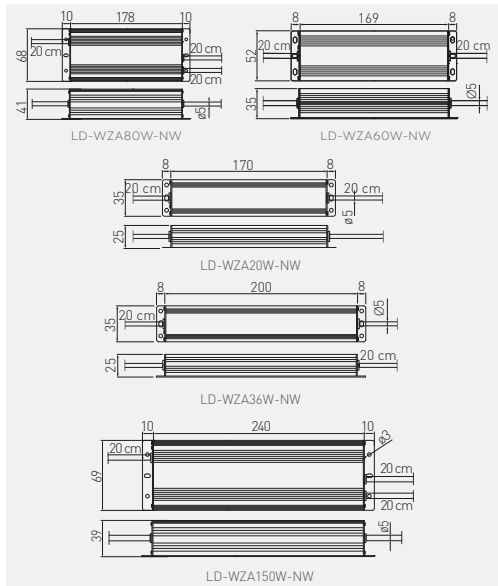

LED-Netzgerät für Montagedosens  
 Boîtier d'alimentation LED  
 Fuente de alimentación LED redonda

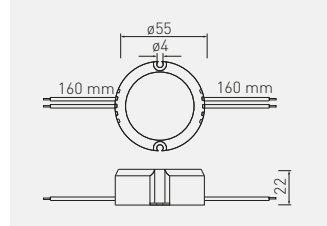



		
LD-ZASPU15W-30N	15 W	Kunststoff, Plastique, plastico

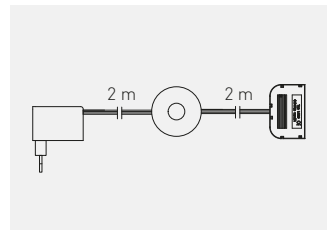

Stromversorgungssystem für 5-Punkt-LED-Clips  
 Système d'alimentation pour clips LED 5 points  
 Sistema de alimentación para clips LED, de 5 puntos



		
LD-ZSKL15-00N	5 x mini AMP	Kunststoff, Plastique, plastico
LD-ZZASG18KKWD6	6 x mini AMP	





Stromversorgungssystem  
Système d'alimentation  
Sistema de alimentación

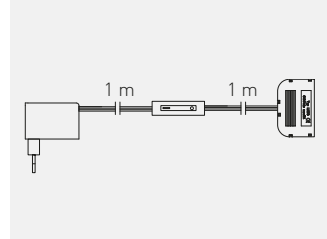

LD-ZWND6W-10	max 6 W	Kunststoff, Plastique, plástico
LD-ZWND12-10	max 12 W	



RGB-Set, Steuergerät, 6W LED-Netzteil, Fernbedienung und Verteiler  
Kit RGB - contrôleur, alimentation 6W LED, télécommande et distributeur  
Conjunto RGB: controlador, fuente de alimentación LED 6W, mando a distancia y distribuidor

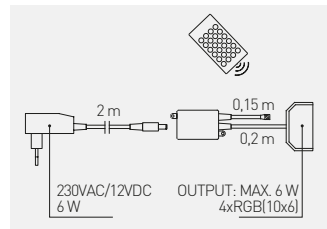

LD-ZAC6WDE-RGB	RGB	Kunststoff, Plastique, plástico



RGB-Mini-Controller mit Fernbedienung  
 Contrôleur RGB mini avec télécommande  
 Controlador RGB mini con control a distancia

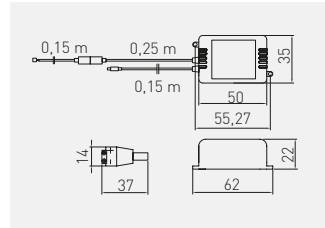

LD-KONMINI-RGB



RGB



Kunststoff, Plastique, plastico

12V  
DCMAX  
72 WMAX  
6 A

IP 20





x50

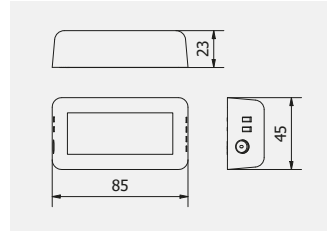

1-Zonen Controller MONO  
 Contrôleur 1 zone MONO  
 Controlador de 1 zona MONO



		
LD-KONML-MONO	MONO	Kunststoff, Plastique, plástico



4-Zonen Fernbedienung MONO  
 Télécommande à 4 zones MONO  
 Mando a distancia de 4 áreas MONO

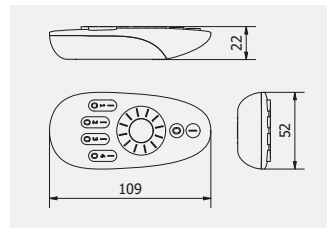

	
LD-KONML-MONO-PIL	Kunststoff, Plastique, plástico



4-Zonen Berührungspanel, batteriebetrieben MONO  
 Écran tactile à 4 zones alimenté par batterie MONO  
 Panel táctil de 4 áreas a pilas MONO

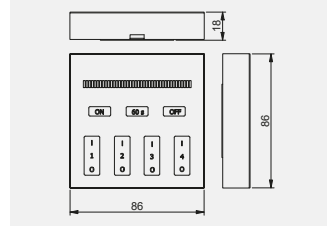

LD-KONML-MONO-PAN

Kunststoff, Plastique, plastico



1-Zonen Controller RGBW  
 Contrôleur 1 zone RGBW  
 Controlador de 1 zona RGBW

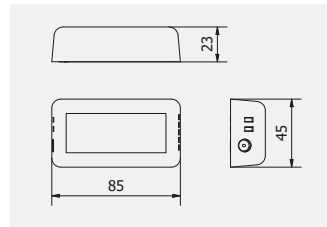

LD-KONML-RGBW



RGBW

Kunststoff, Plastique, plastico

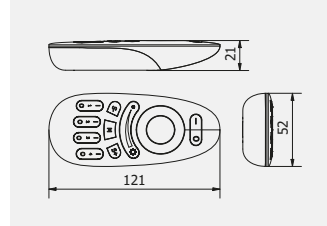

4-Zonen Fernbedienung RGBW  
Télécommande à 4 zones RGBW  
Mando a distancia de 4 áreas RGBW





		
LD-KONML-RGBW-PIL	RGBW	Kunststoff, Plastique, plástico

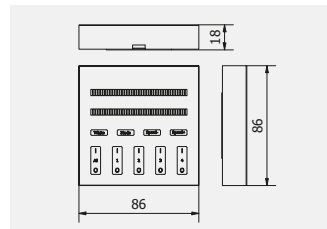

4-Zonen Berührungspanel, batteriebetrieben RGBW  
Écran tactile à 4 zones alimenté par batterie RGBW  
Panel táctil de 4 áreas a pilas RGBW



		
LD-KONML-WRGB-PAN	RGBW	Kunststoff, Plastique, plástico



WiFi-Controller  
Contrôleur WiFi  
Controlador WiFi

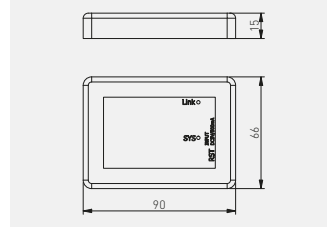

LD-KONML-WIFI



RGB



Kunststoff, Plastique, plástico



Adapter für Fernbedienung  
Adaptateur de télécommande  
Adaptador para mando a distancia

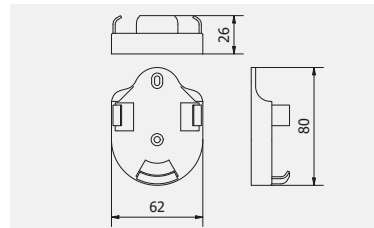

LD-KONML-AD



weiß, blanc, blanco



Kunststoff, Plastique, plástico



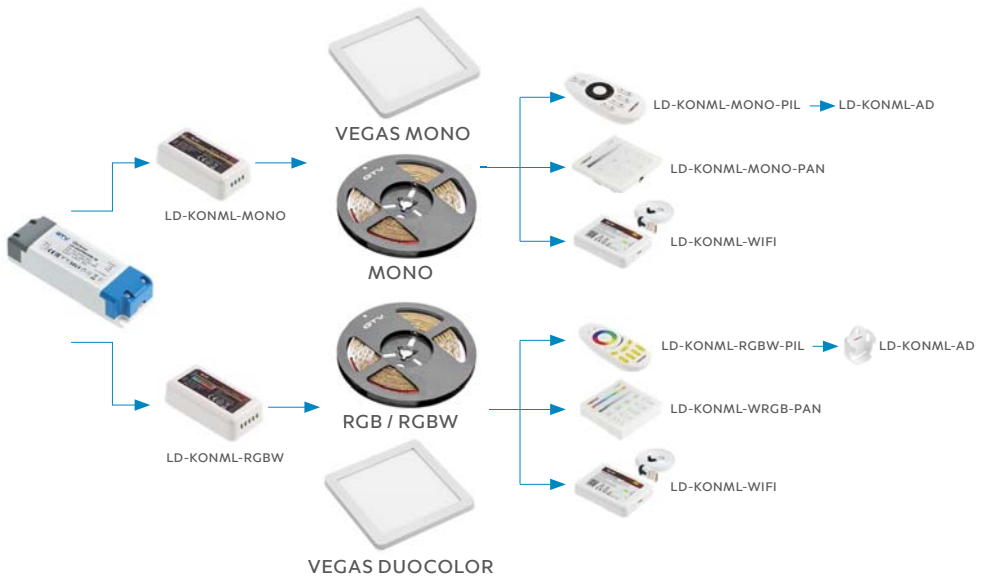

Kabelloser Berührungsschalter on-off  
 Interrupteur sans contact sans fil on-off  
 Interruptor táctil inalámbrico on-off

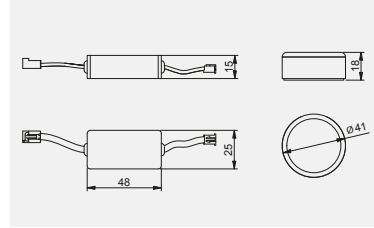

AE-WDBP1-10 N	weiß, blanc, blanco	Kunststoff, Plastique, plastico
AE-WDBP1-20 N	schwarz, noir, negro	



Kabelloser Berührungsschalter CCT  
 Interrupteur sans contact sans fil CCT  
 Interruptor táctil inalámbrico CCT

NEW

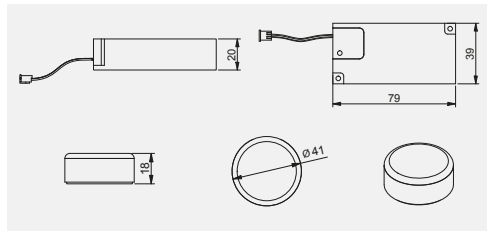

AE-WDBP2CCT-10N	weiß, blanc, blanco	Kunststoff, Plastique, plastico
AE-WDBP2CCT-20N	schwarz, noir, negro	







Berührungsloser Schalter  
 Interrupteur de proximité  
 Interruptor sin contacto

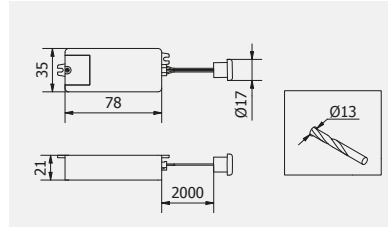

AE-WBEZDC-10S	Bewegungsschalter, bipolaire, modo táctil	Kunststoff, Plastique, plástico
AE-WBEZDB-10S*	Schranktür-Schalter, unipolaire, modo puerta	



Berührungsschalter, zum Anschließen an Metallgegenstände  
 Interrupteur tactile sous la vis  
 Interruptor táctil para el tornillo

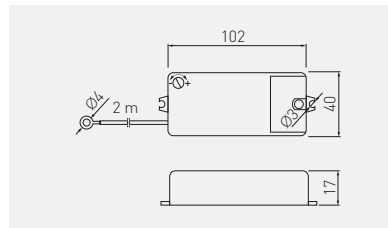

AE-WBEZDK15-10	Kunststoff, Plastique, plástico
----------------	---------------------------------



Schalter mit Bewegungsmelder PIR  
 Interrupteur avec détecteur de mouvement à infrarouge PIR  
 Interruptor con detector de movimiento PIR

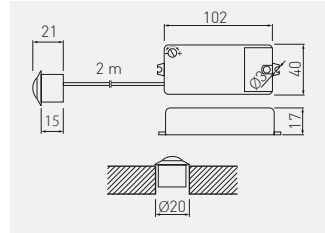

AE-WBEZDPIR-10

Kunststoff, Plastique, plastico



Schalter mit zwei Bewegungsmeldern PIR II  
 Interrupteur avec deux détecteurs de mouvement PIR  
 Interruptor con dos detectores de movimiento PIR II

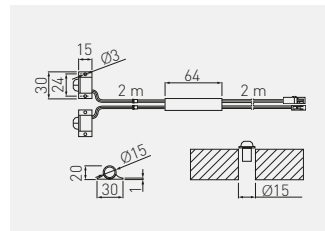

AE-WBEZDPIR2-20

Kunststoff, Plastique, plastico



3-in-1 universeller berührungsloser Schalter  
 Interrupteur de proximité universel 3 en 1  
 Interruptor sin contacto universal 3 en 1

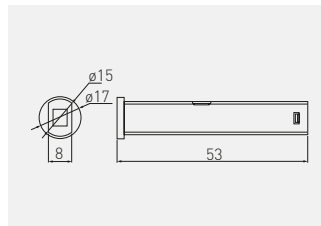

AE-WBBUNI-10DIM	weiß, blanc, blanco	Kunststoff, Plastique, plastico
AE-WBCUNI-10DIM	schwarz, noir, negro	



Berührungsloser Schalter, Mikro  
 Interrupteur de proximité, micro  
 Interruptor sin contacto, micro

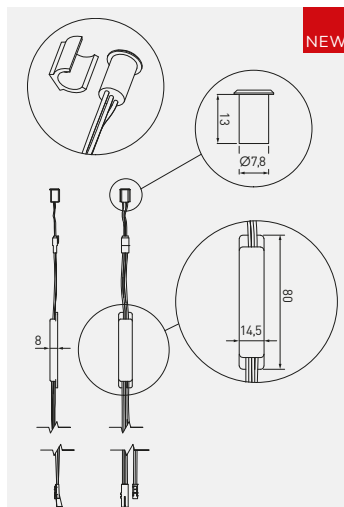

AE-WBE1-20	schwarz, noir, negro	Kunststoff, Plastique, plastico
AE-WBE1-10	weiß, blanc, blanco	



Berührungsloser Schalter, Mikro  
Interrupteur de proximité, micro  
Interruptor sin contacto, micro



AE-WBE2-20	schwarz, noir, negro	Kunststoff, Plastique, plástico
AE-WBE2-10	weiß, blanc, blanco	

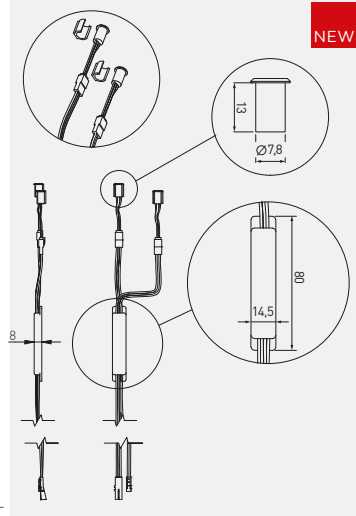

Dimmer mit Berührungsschalter  
Interrupteur tactile gradation  
Interruptor con regulador de intensidad



AE-WDSB-10DIM	weiß, blanc, blanco	Kunststoff, Plastique, plástico
AE-WDSC-10DIM	schwarz, noir, negro	

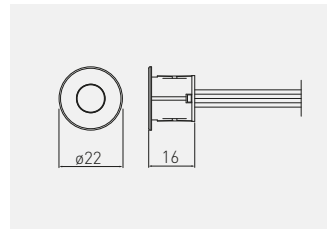

Dimmer mit Berührungsschalter  
 Interrupteur tactile gradation  
 Interruptor con regulador de intensidad

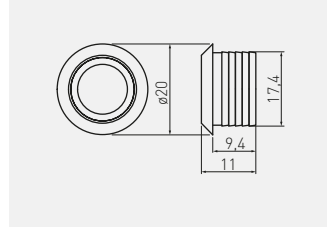

AE-WBEZD-NBN

Chrom, chrome, cromado

Kunststoff, Plastique, plastico



Unterblattschalter  
 Interrupteur caché  
 Interruptor para montaje bajo esa

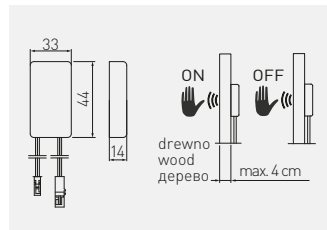

Plattenstärke max. 40 mm  
 Épaisseur de la plaque max 40 mm  
 Grosor de la encimera máx. 40 mm



AE-WPDRW-00

Kunststoff, Plastique, plastico



Schalter für LED-Streifen, montiert im Profil  
 Interrupteur pour rubans LED monté en profilé  
 Interruptor para tiras LED, instalado en perfil

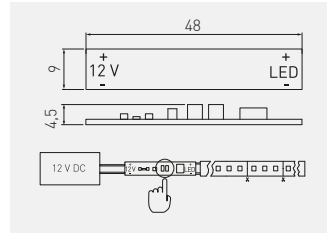

AE-WLPR-60	-	weiß, blanc, blanco	Elektronikplatine, Plaque conductrice, Placa electrónica	1000
AE-WLPR-60P2	2 m			500



Wippschalter  
 Interrupteur silencieux  
 Interruptor basculante

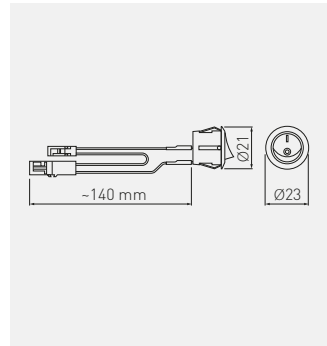

AE-WLB01-10	weiß, blanc, blanco	Kunststoff, Plastique, plástico
AE-WLC01-20	schwarz, noir, negro	



Wippschalter rund  
Interrupteur rond  
Interruptor redondo





		
AE-WLIP44-15	weiß, blanc, blanco	Kunststoff, Plastique, plastico

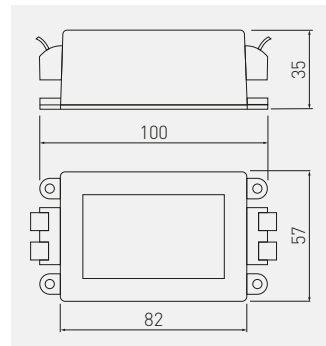

LED-Dimmer  
Variateur de lumière LED  
Atenuador de luz LED



			
LD-DIMLED-10	schwarz, noir, negro	PC	800 g





Kettenzugschalter  
 Interrupteur à chaîne  
 Interruptor de cadena

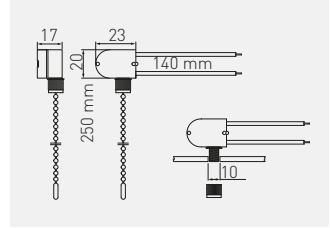

AE-WLLAN1-10	Chrom, chrome, cromado	Kunststoff, Plastique, plastico
AE-WLLAN1-90	gold, d'or, de oro,	
AE-WLLAN1-20	schwarz, noir, negro	



Zugschalter mit Schnur  
 Interrupteur à cordon  
 Interruptor de cable



AE-WLSZN1-10	schwarz, noir, negro	Polypropylen, polypropylène, polipropileno
--------------	----------------------	--



Netzkabel mit Stecker und Schalter  
 Câble d'alimentation avec fiche et interrupteur  
 Cable de alimentación con enchufe e interruptor

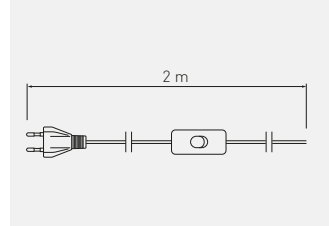



		
LD-KABE2M-00	weiß, blanc, blanco	Kunststoff, Plastique, plástico

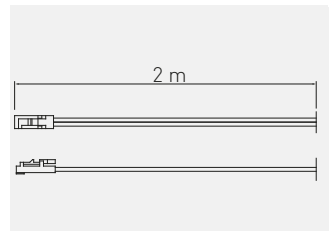

Kabel mit Mini-AMP-Steckverbindern  
 Conduit avec raccords mini AMP  
 Conducto con conectores mini AMP



		
LZ-KA2MM-10	schwarz, noir, negro	Kunststoff, Plastique, plástico



Kabel mit mini AMP-Verbindern  
 Conduit avec raccords mini AMP  
 Cable con conectores mini AMP

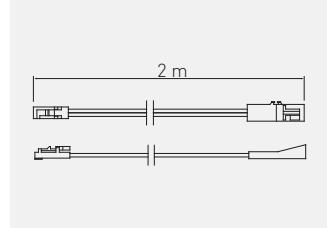

LZ-KAPR2M-10



schwarz, noir, negro



Kunststoff, Plastique, plastico



Verteiler für LED-Beleuchtung, 3-fach  
 Raccord pour l'éclairage LED avec distributeur, 3 prises  
 Conector para alumbrado LED con distribuidor, 3 entradas

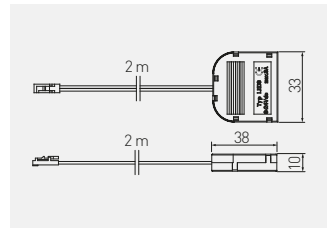

LZ-AKZ312-10N



schwarz, noir, negro



Kunststoff, Plastique, plastico



Verteiler für LED-Beleuchtung, 6-fach  
 Raccord pour l'éclairage LED avec distributeur, 6 prises  
 Conector para iluminación LED con distribuidor, 6 entradas

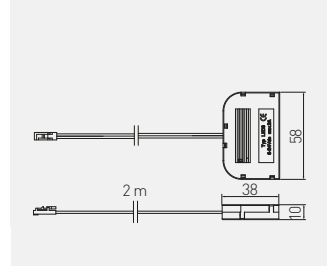

LZ-AKZ612-10N	schwarz, noir, negro	Kunststoff, Plastique, plástico



Verbinder für LED-Streifen COB  
 Raccord pour rubans LED COB  
 Conector para tiras LED COB

NEW

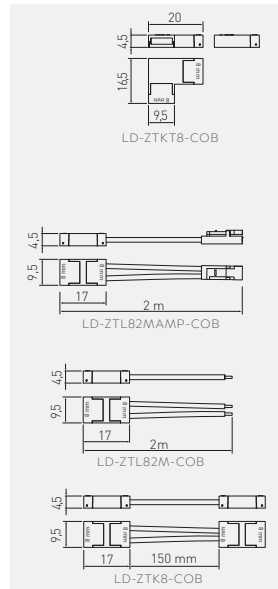

LD-ZTL82MAMP-COB	Kunststoff, Plastique, plástico
LD-ZTL82M-COB	
LD-ZTL8-COB	
LD-ZTK8-COB	



## Verbinder XC11 für LED-Streifen Raccord XC11 pour rubans LED Conector XC11 para tiras LED



LD-ZTL10MM-02N

LD-ZTL8MM-02N600

LD-ZTLRGB-04N

LD-ZTL8MM-02N600	8 mm / 600 LED	Kunststoff, Plastique, plástico
LD-ZTL10MM-02N	10 mm	
LD-ZTLRGB-04N	RGB	



LD-ZTL8MM-02N600



LD-ZTL10MM-02N , LD-ZTLRGB-04N



## Eckverbinder XC11 für LED-Streifen Connecteur XC11 pour rubans LED d'angles Conector XC11 para tiras LED angular



LD-ZTKT10MM-02N

LD-ZTKT8MM-02N600

LD-ZTKTRGB-02N

LD-ZTKT8MM-02N600	8 mm / 600 LED	Kunststoff, Plastique, plástico
LD-ZTKT10MM-02N	10 mm	
LD-ZTKTRGB-04N	RGB	

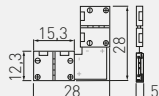

LD-ZTKT8MM-02N , LD-ZTKT8MM-02N600

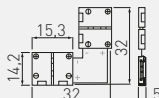

LD-ZTKTRGB-04N



Verbinder XC11 für LED-Streifen 8 mm mit Kabel 15 cm  
 Connecteur XC11 pour rubans LED avec 15 cm de câble  
 Conector XC11 para tiras LED con cable de 15 cm

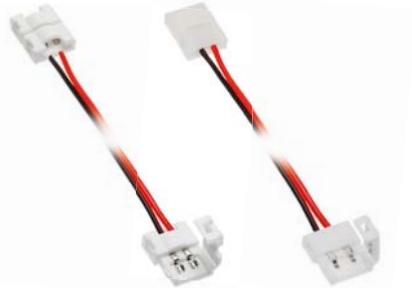

LD-ZTK8MM-02N600 LD-ZTK10MM-02N

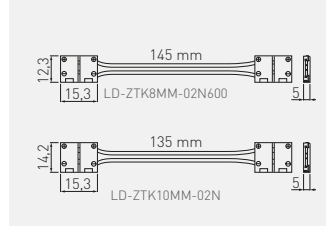

LD-ZTK8MM-02N600	8 mm / 600 LED	Kunststoff, Plastique, plastico
LD-ZTK10MM-02N	10 mm	



Verbinder XC11 für LED-Streifen SLIM  
 Raccord XC11 pour rubans LED SLIM  
 Conector XC11 para tiras LED SLIM



LD-ZTLS8MM-02N LD-ZTKS8MM-02N LD-ZTLS82M-2N LD-ZTLS8MMAMP-02N

LD-ZTLS8MM-02N	8 mm	-	Kunststoff, Plastique, plastico
LD-ZTKS8MM-02N		15 cm	
LD-ZTLS82M-2N		200 cm	
LD-ZTLS8MMAMP-02N		200 cm + mini amp	

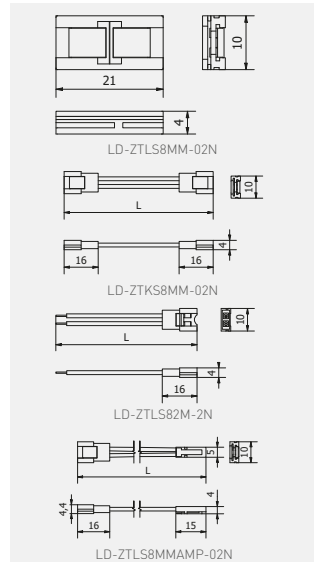

Induktionsladegerät mit Netzgerät  
 Chargeur à induction avec alimentation  
 Cargador de inducción con alimentación



360°

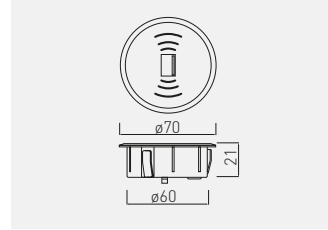

AE-ZUSB-20



schwarz, noir, negro



Kunststoff, Plastique, plástico

5V  
DCMAX  
0,5 W

IP 20

USB MAX  
2,1 A

MAX TA

ø60mm

x 50



EAC

UK  
CA

Kabelloses Ladegerät LUX mit Trafo  
 Chargeur à induction avec alimentation LUX  
 Cargador de inducción con alimentación LUX

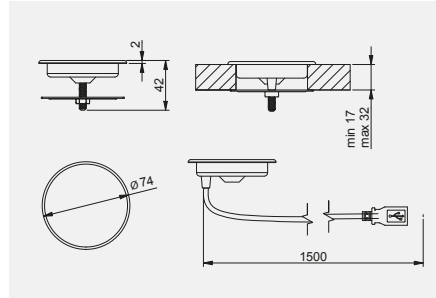

AE-ZLADLUX-40

Chrom, chrome, cromado

Kunststoff, Plastique, plástico



Induktionsladegerät mit Netzteil für Mobiltelefone, Untertischmontage  
 Chargeur sans fil, monté sous le chargeur avec alimentation électrique  
 Cargador inalámbrico bajo mesa con fuente de alimentación

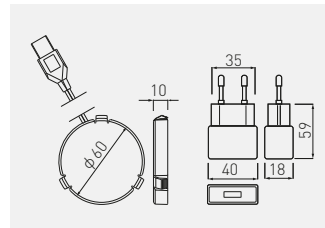

AE-ZLADPOD-20

schwarz, noir, negro

Kunststoff, Plastique, plástico







Möbel-Einbausteckdose  
Prise de courant pour meubles encastrée  
Enchufe para muebles empotrado



## PRESTINO

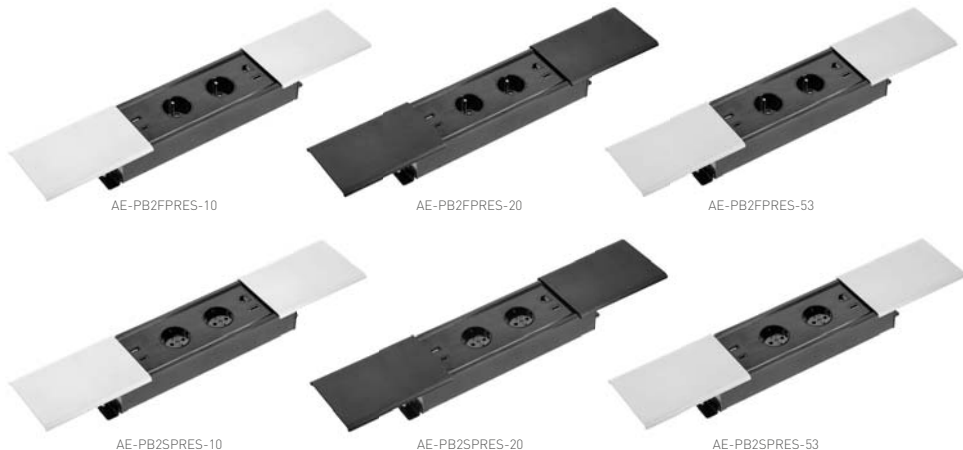

AE-PB2FPRES-20			2 x french	Aluminium, aluminium, aluminio	Aluminium + Kunststoff, aluminium + Plastique, aluminio + plastico
AE-PB2SPRES-20			2 x schuko		
AE-PB2FPRES-53		USB-A + USB-C DC5V 3A (max 15,0W) DC9V 2A (MAX. 18,0W) DC12V 1.5A (MAX. 18,0W)	2 x french		
AE-PB2SPRES-53			2 x schuko		
AE-PB2FPRES-10			2 x french		
AE-PB2SPRES-10			2 x schuko		

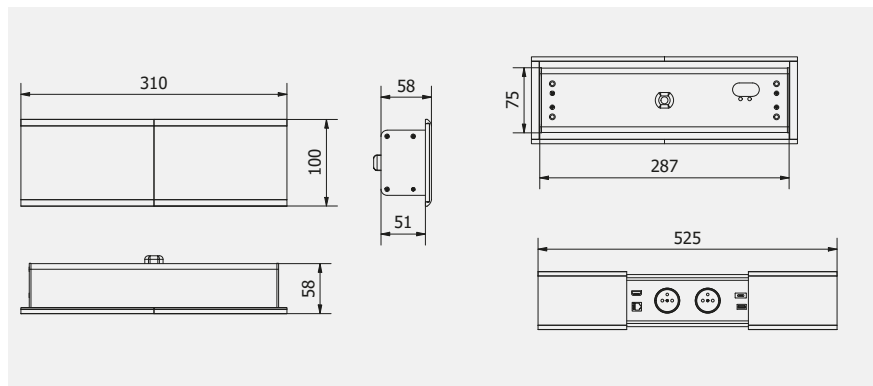

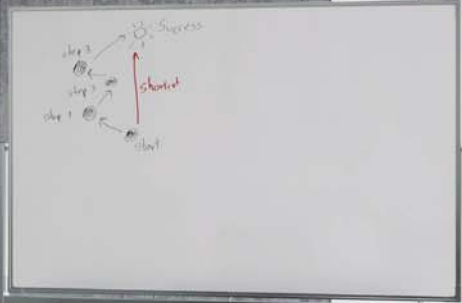

Möbel-Einbausteckdose  
Prise de courant pour meubles encastrée  
Enchufe para muebles empotrado



## CHARGER PLUS



AE-BPW1FACP-10



AE-BPW1SACP-10

AE-BPW1FACP-10	USB A+C 5V/2,4A interchangeable: USB A, HDMI, RJ45	1 x french	weiß, blanc, blanco	Kunststoff, plastique, plástico
AE-BPW1FACP-20		1 x french	schwarz, noir, negro	
AE-BPW1SACP-10		1 x schuko	weiß, blanc, blanco	
AE-BPW1SACP-20		1 x schuko	schwarz, noir, negro	

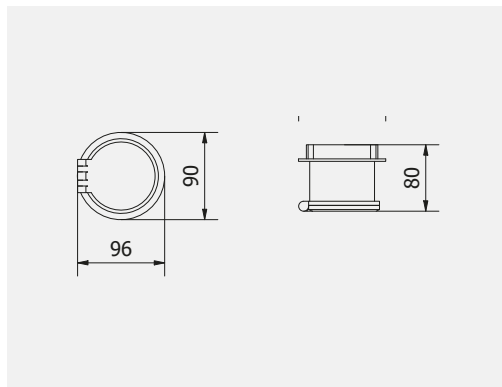

Included





Möbel-Einbausteckdose  
Prise de courant pour meubles encastrée  
Enchufe para muebles empotrado



## COMFORT PLUS



AE-BPW4F120P-10



AE-BPW4S120P-10

AE-BPW4F120P-10	2xUSB 5V/3,1A 2xRJ45	4 x french	weiß, blanc, blanco	Kunststoff, plastique, plástico
AE-BPW4F120P-20			schwarz, noir, negro	
AE-BPW4S120P-10		4 x schuko	weiß, blanc, blanco	
AE-BPW4S120P-20			schwarz, noir, negro	

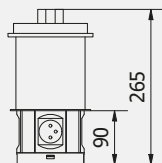





Möbel-Einbausteckdose  
Prise de courant pour meubles encastrée  
Enchufe para muebles empotrado



## CAMINO



AE-BPW2FCAM-20



AE-BPW2FCAM-10

AE-BPW2FCAM-20	USB-A + USB-C DC5V 3A (max 15,0W) DC9V 2A (MAX. 18,0W) DC12V 1.5A (MAX. 18,0W)	2 x french	schwarz, noir, negro	Aluminium + Kunststoff, aluminium + Plastique, aluminio + plastico
AE-BPW2SCAM-20		2 x schuko		
AE-BPW2FCAM-10		2 x french	weiß, blanc, blanco	
AE-BPW2SCAM-10		2 x schuko		

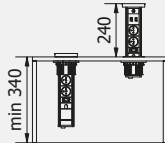
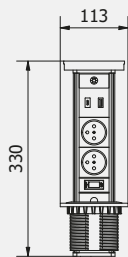





Möbel-Einbausteckdose  
Prise de courant pour meubles encastrée  
Enchufe para muebles empotrado



## AVARO PLUS



AE-PB1FAVAP-10



AE-PB1SAVAP-10

AE-PB1FAVAP-20	i USB-A + USB-C DC5V 3A (max. 15,0W) DC9V 2A (MAX. 18,0W) DC12V 1.5A (MAX. 18,0W)	1 x french	schwarz, noir, negro	Aluminium + Kunststoff, aluminium + Plastique, aluminio + plastico
AE-PB1SAVAP-20		1 x schuko		
AE-PB1FAVAP-53		1 x french	grau, gris, gris	
AE-PB1SAVAP-53		1 x schuko		
AE-PB1FAVAP-10		1 x french	weiß, blanc, blanco	
AE-PB1SAVAP-10		1 x schuko		

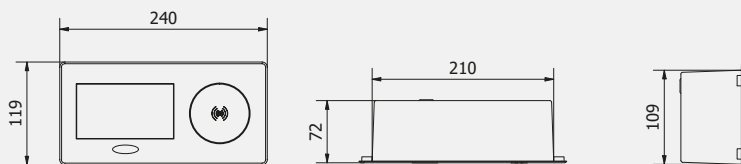



Möbel-Einbausteckdose  
Prise de courant pour meubles encastrée  
Enchufe para muebles empotrado



## AVARO



AE-PB1FAVA-10



AE-PB1SAVA-10

AE-PB1FAVA-20	USB A DC5V 2A (MAX. 10,0W)	1 x french	schwarz, noir, negro	Aluminium + Kunststoff, aluminium + Plastique, aluminio + plastico
AE-PB1SAVA-20		1 x schuko		
AE-PB1FAVA-53		1 x french	grau, gris, gris	
AE-PB1SAVA-53		1 x schuko		
AE-PB1FAVA-10		1 x french	weiß, blanc, blanco	
AE-PB1SAVA-10		1 x schuko		

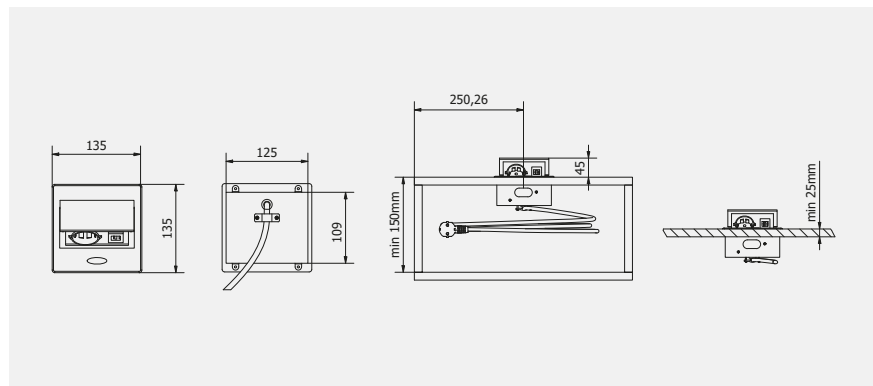



GTV  
LIGHTING

GTV  
LIGHTING

Möbel-Einbausteckdose  
Prise de courant pour meubles encastrée  
Enchufe para muebles empotrado

## CHARGER



AE-BPW1S2UCH-80

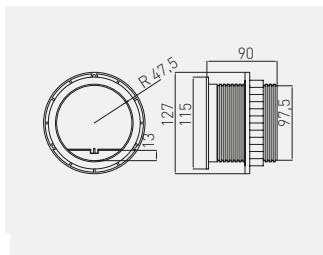

AE-BPW1S2UCH-80	1 x schuko	silberfarben, Argent, plata	Kunststoff, Plastique, plastico
AE-BPW1U2UCH-80	1 x french		



Möbel-Einbausteckdose  
Prise de courant pour meubles encastrée  
Enchufe para muebles empotrado

## CHARGER MINI



AE-BPW1S1UCH-53

AE-BPW1U1UCH-53

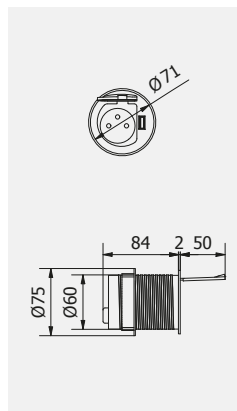

AE-BPW1U1UCH-53	1 x french	Aluminium, aluminium, aluminio	Kunststoff, Plastique, plastico
AE-BPW1S1UCH-53	1 x schuko		





Möbel-Einbausteckdose  
Prise de courant pour meubles encastrée  
Enchufe para muebles empotrado



## SLIDE



AE-BPW1U1UCH-51

AE-BPW1S1UCH-51

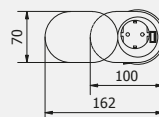
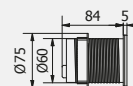

AE-BPW1U1UCH-51	USB 5V / 2,4A	1 x french	Aluminium, aluminium, aluminio	Kunststoff, Plastique, plastico
AE-BPW1S1UCH-51		1 x schuko		



Möbel-Einbausteckdose  
Prise de courant pour meubles encastrée  
Enchufe para muebles empotrado



## COMFORT



AE-BPW3S100U-53

AE-BPW4U100-53

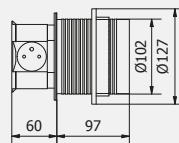

AE-BPW4U100-53	-	4 x french	Aluminium, aluminium, aluminio	Aluminium + Kunststoff, aluminium + Plastique, aluminio + plastico
AE-BPW4S100-53		4 x schuko		
AE-BPW3U100U-53	USB 5V / 2,4A	3 x french		
AE-BPW3S100U-53		3 x schuko		



Runde Möbel-Einbausteckdose  $\varnothing$  100  
 Prise de courant pour meubles encastrée ronde  $\varnothing$  100  
 Enchufe redondo  $\varnothing$  100 empotrado para muebles

360°



AE-BPW3GU-20

AE-BPW3GU-20	100	3 x french	schwarz, noir, negro	Aluminium + Kunststoff, aluminium + Plastique, aluminio + plastico
AE-BPW3GU-80			silberfarben, Argent, plata	
AE-BPW3GS-20		3 x schuko	schwarz, noir, negro	
AE-BPW3GS-80			silberfarben, Argent, plata	

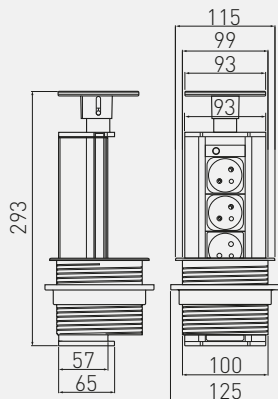





Runde Möbel-Einbausteckdose ø 60  
 Prise de courant pour meubles encastrée ronde ø 60  
 Enchufe redondo ø 60 empotrado para muebles

360°



AE-BPW3U60-80

AE-BPW3U60U-20

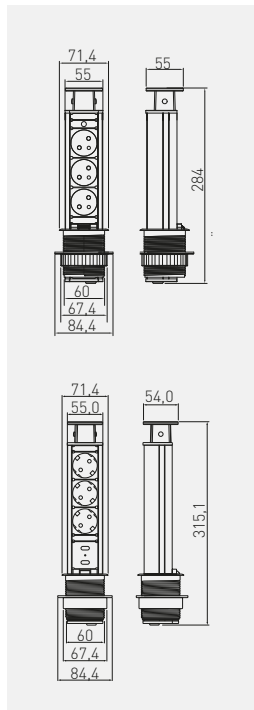

AE-BPW3U60-20	60	3 x french	5V USB	schwarz, noir, negro	Aluminium + Kunststoff, aluminium + Plastique, aluminium + plastico
AE-BPW3U60-80				silberfarben, Argent, plata	
AE-BPW3S60-20		3 x schuko		schwarz, noir, negro	
AE-BPW3S60-80				silberfarben, Argent, plata	
AE-BPW3U60U-20		3 x french		schwarz, noir, negro	
AE-BPW3U60U-80				silberfarben, Argent, plata	
AE-BPW3S60U-20		3 x schuko		schwarz, noir, negro	
AE-BPW3S60U-80				silberfarben, Argent, plata	



Rechteckige Möbel-Einbausteckdose  
Prise de courant pour meubles encastrée rectangulaire  
Enchufe rectangular empotrado para muebles

360°



AE-PBC3GU-20

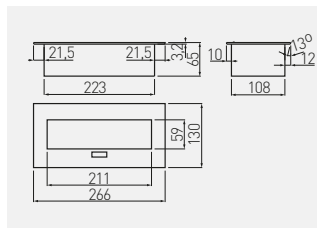

AE-PB03GS-53	-	3 x schuko	Aluminium, aluminium, aluminio	Stahl + Kunststoff, acier + Plastique, acero + plastico
AE-PB03GS-20	-	3 x schuko		
AE-PB03GS-10	-	3 x schuko		
AE-PB03GU-53	-	3 x french		
AE-PBC3GU-53	1,5 m	3 x french	schwarz, noir, negro	
AE-PBC3GU-10	1,5 m	3 x french	weiß, blanc, blanco	



Rechteckige Möbel-Einbausteckdose  
Prise de courant pour meubles encastrée rectangulaire  
Enchufe rectangular empotrado para muebles

360°



AE-PBU2GU-10

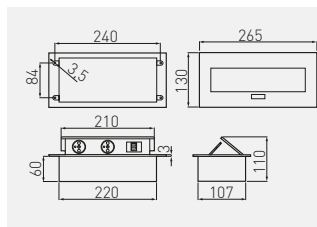

AE-PBU02GS-10	2 x schuko	weiß, blanc, blanco	Stahl + Kunststoff, acier + Plastique, acero + plastico
AE-PBU02GS-20		schwarz, noir, negro	
AE-PBU2GU-10	2 x french	weiß, blanc, blanco	
AE-PBU2GU-20		schwarz, noir, negro	
AE-PBU2GU-53		Aluminium, aluminium, aluminio	



Möbel-Einbausteckdose  
Prise de courant pour meubles encastrée  
Enchufe para muebles empotrado



360°



## SOFT



AE-PBSC3GS-20



AE-PBSC3GS-53



AE-PBSUC2GS-20



AE-PBSUC2GS-53



AE-PBSC3GS-10	3 x schuko	-	weiß, blanc, blanco	Stahl + Kunststoff, acier + Plastique, acero + plastico
AE-PBSC3GS-20N			schwarz, noir, negro	
AE-PBSC3GS-53			Aluminium, aluminium, aluminio	
AE-PBSC3GU-10	3 x french	-	weiß, blanc, blanco	
AE-PBSC3GU-20N			schwarz, noir, negro	
AE-PBSC3GU-53			Aluminium, aluminium, aluminio	
AE-PBSUC2GS-10	2 x schuko	5V USB max 2A	weiß, blanc, blanco	
AE-PBSUC2GS-20N			schwarz, noir, negro	
AE-PBSUC2GS-53			Aluminium, aluminium, aluminio	
AE-PBSUC2GU-10	2 x french	-	weiß, blanc, blanco	
AE-PBSUC2GU-20N			schwarz, noir, negro	
AE-PBSUC2GU-53			Aluminium, aluminium, aluminio	

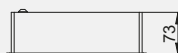



Durchgehende Möbelsteckdose mit USB  
Prise de courant pour meubles à traversée avec USB  
Enchufe para muebles con USB

360°



AE-PBC3GS-53BK

AE-PBC3GS2U-53BK

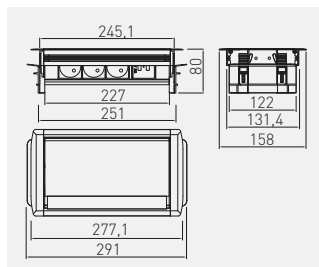

AE-PBC3GS-53BK	3 x schuko	-	Aluminium, aluminium, aluminio	Aluminium + Kunststoff, aluminium + Plastique, aluminio + plastico
AE-PBC3GS2U-53BK	3 x schuko	5V USB max 2A		



Möbelsteckdose ohne Gehäuse  
Prise de courant pour meubles sans cassette  
Enchufe para muebles sin caja



360°



AE-PBC3GS-51BK

AE-PBC3GU-51BK

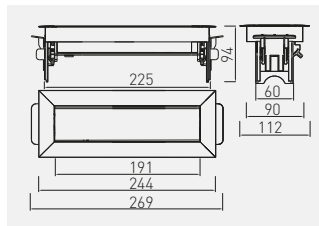

AE-PBC3GS-51BK	3 x schuko	Edelstahloptik, acier brossé, acero pulido		Stahl + Kunststoff, acier + Plastique, acero + plastico
AE-PBC3GU-51BK	3 x french			



Eck-Möbelsteckdose  
Prise de courant pour meubles d'angle  
Enchufe para muebles de esquina



AE-PBKT4S-80

AE-PBKT3U2U-80

AE-PBKT4U-80	4 x french	-	silberfarben, Argent, plata	Aluminium + Kunststoff, aluminium + Plastique, aluminio + plastico
AE-PBKT4S-80	4 x schuko			
AE-PBKT3U2U-80	3 x french	5V USB max 2A		
AE-PBKT3S2U-80	3 x schuko			

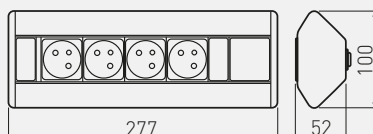













































# ERLÄUTERUNG VON SYMBOLEN / ICÔNES EXPLICATIVES / SIGNIFICADO DE SÍMBOLOS

	Artikelnummer référence índice		Breite largeur ancho		weitere Informationen informations complémentaires información adicional
	Höhe der Montageplatte hauteur du guide altura de la guía		Abmessungen (mm) dimension (mm) medidas (mm)		Schutzart IP degré de protection IP grado de protección IP
	Spannplattenschrauben vis ordinaires tornillos simples		Abmessungen (m) dimension (m) medidas (m)		Schnittabstand distance de coupe distancia de corte
	Euroschrauben vis euro eurotornillos		Materialstärke épaisseur grosor		Breite largeur de la bande ancho de la tira
	Beschichtung recouvrement revestimiento		Außenbreite des Schrankes largeur extérieure de l'armoire ancho exterior del armario		USB USB USB
	Farbe couleur color		Material matériau material		Typ der Steckdose type de prise tipo de toma
	Belastbarkeit charge carga		Auszug extension extensión		Leistung puissance potencia
	Volumen capacité capacidad		Form forme forma	Möbelbeschläge Accessoires de meubles Accesorios de muebles	
	Widerstandskraft résistance mécanique fuerza de resistencia		Lichtstrom lux lumineux ujo luminoso		
	Länge longueur largo		Kabellänge Longueur du câble largo del cable		Eckanschlag charnière appliquée bisagra de recta
	Bohrlochabstand écartement distancia		Diodenzahl nombre de diodes número de LEDs		Mittelschlag charnière jumelle bisagra acodada
	Höhe hauteur alto		Gehäusefarbe couleur du boîtier color de la carcasa		Innenanschlag charnière encastrée bisagra superacodada
	Auszugsverlust perte d'extension pérdida de extensión		Farbtemperatur température de couleur temperatura de color de la luz		Winkelschmier charnière d'angle bisagra angular
	Durchmesser diamètre diámetro		Strahlungswinkel angle de diusion de la lumière ángulo de luz		Weitwinkelschmier charnière grand-angle d'ouverture bisagra de gran ángulo de apertura
	* Benutzerfreundliche Produkte Produits conviviaux pour utilisateur Productos fáciles de usar				Stollenschmier charnière parallèle bisagra paralela

\*GTV-Produkte, die mit diesem Symbol gekennzeichnet sind, unterliegen einer gründlichen Prüfung. Dank der speziell ausgewählten Materialzusammensetzung erfüllen Sie die höchsten Umweltrichtlinien. Der Endverbraucher erhält das Produkt, das sicher ist, und dessen störungsfreier Betrieb viele Jahre Freude bereitet wird.  
 Les produits GTV marqués de ce symbole sont soumis à une inspection approfondie. Leur composition de matériaux spécialement sélectionnés les rend conformes à l'une des directives environnementales les plus élevées. L'utilisateur final reçoit un produit sûr dont le fonctionnement sans panne sera apprécié pendant de nombreuses années.  
 Los productos GTV marcados con este símbolo se someten a un cuidadoso control. Su composición de materiales especialmente seleccionados hace que cumplan las directrices medioambientales más estrictas. El usuario final recibe un producto seguro, que funcionará sin problemas durante muchos años.



	Stollenanschlag, aufschlagende Tür charnière parallèle appliquée bisagra paralela de superficie		SLIDE-ON Slide-On-Montage Méthode de montage par slide-on modo de montaje slideon		PUSH push-to-open
	Zusatzcharnier charnière supplémentaire bisagra suplementaria		SLOW Scharnier mit integrierter Dämpfung charnière avec mécanisme de fermeture silencieux bisagra con mecanismo de cierre silencioso		FULL Vollauszug extension complète extensión completa
	Verstellbarkeit réglage ajuste		Scharnier mit Anzugsfeder charnière à ressort de rappel bisagra con muelle de cierre		Standardschublade Tiroir standard cajón estándar
	einstufige Funktion action en une seule étape operación en una fase		selbstöffnendes Scharnier charnière à ouverture automatique bisagra de apertura automática		Schublade für Küchenspüle Tiroir évier cajón bajo fregadero
	zweistufige Funktion action en deux temps operación en dos fases		Scharnier ohne Feder charnière sans ressort bisagra sin muelle		Eckschublade Tiroir d'angle cajón rinconero
	SPECIAL Scharnier für spezielle Anwendungen charnière pour applications des spéciales bisagra para aplicaciones especiales		A Niedrige Schublade Tiroir bas cajón bajo		Standardschublade Tiroir standard cajón estándar
	Topfdurchmesser diamètre de boîte diámetro de la cazoleta		B Mittelhohe Schublade Tiroir moyen cajón medio		Innenschublade Tiroir intérieur cajón interior
	Abstand zwischen Montageöffnungen am Scharniertopf espacement des ouvertures des boîtes distancia de atomillado en la cazoleta		C Hohe Schublade Tiroir haut cajón alto		Unterflurführung rail de guidage inférieur guía de montaje inferior
	Topfmontage mit Spanplattenschrauben installation de la boîte avec vis à bois instalación de la caja de tornillos para madera		vertikale und horizontale Verstellung réglage vertical et horizontal ajuste vertical y horizontal		Kugelführung guidage à billes guía de bolas
	Montage der Montageplatte mit Spanplattenschrauben Vis de bois installation plaque de montage tornillo rosca madera para montaje de la base		Möglichkeit der Entriegelung der Schublade option de retrait opción de desconexión		Rollschubführung guidage à rouleaux guía de rodillos
	Montage der Montageplatte mit Euroschrauben installation d'un guide avec vis euro montaje de una guía de euro tornillo		H=83 Zargenhöhe MB Square hauteur du côté carré MB alto del panel lateral MB Square		Metalbox metalbox metalbox
	Montage der Montageplatte mit Dübeln installation d'un guide avec chevilles montaje de la guía en pasadores		H=83 Zargenhöhe MB hauteur du côté MB alto del panel lateral MB		SLOW Dämpfung Fermeture silencieuse cierre silencioso
	Exzentereinstellung réglage excentrique ajuste excéntrico		H=95 Zargenhöhe Axis hauteur du côté AXIS alto del panel lateral AXIS		SELF CLOSING Selbstenzug usines de distribution d'eau cierre automático
	x 100 Verpackung emballage envasado		3D 3D-Modell verfügbar disponible en 3D cuerpo en 3D disponible		Montage mit Rastkupplung montage coulissant avec accouplement montaje deslizante con acoplamiento
	CLIP-ON Clip-On-Montage méthode de montage par clip-on método de instalación clip-on		CERTIFICATE 60.000 Lebensdauer durée de vie durabilidad		Montage ohne Rastkupplung montage appliqué montaje de superficie

 \* Für Bauanwendungen  
Pour les applications de construction  
Para construcción

\*Alle im Katalog vorgestellten Produkte sind für die Verwendung in Möbeln bestimmt, sofern andere Verwendung nicht neben dem Produkt angegeben ist.  
Tous les produits présentés dans le catalogue sont destinés à l'ameublement, à moins qu'une application différente ne soit indiquée pour le produit.  
Todos los productos presentados en el catálogo son para muebles, a menos que se indique un uso diferente del producto.



Teilauszug  
extension partielle  
extensión parcial



max. Plattenstärke  
épaisseur max. des plaques  
grosor máx. de la placa



Vertikalverstellung  
réglage vertical  
ajuste vertical



Horizontalverstellung  
réglage horizontal  
ajuste horizontal



Tiefenverstellung  
réglage en profondeur  
ajuste de profundidad



bestimmt für Glas  
application sur verre  
aplicación a vidrio



bestimmt für Glas 4 mm  
application sur verre 4 mm  
aplicación a vidrio 4 mm



bestimmt für Platte  
application sur plaque  
aplicación a tablero



bestimmt für Platte 18 mm  
applicable jusqu'à 18 mm  
aplicación a tablero de 18 mm



bestimmt für Platte 12 mm  
applicable sur plaque jusqu'à 12 mm  
aplicación a tablero de 12 mm



bestimmt für Platte 16 mm  
applicable sur plaque jusqu'à 16 mm  
aplicación a tablero de 16 mm



bestimmt für Platte 10 mm  
applicable sur plaque jusqu'à 10 mm  
aplicación a tablero de 10 mm



bestimmt für Platte ≥16 mm  
pour une utilisation sur des panneaux ≥ 16 mm  
aplicación a tablero ≥16 mm



bestimmt für Platte 16 - 22 mm  
pour une utilisation sur des panneaux de 16 à 22 mm  
aplicación a tablero de 16- 22 mm



bestimmt für Platte 16 - 28 mm  
Pour une utilisation sur des panneaux de 16 à 28 mm  
aplicación a tablero de 16 - 28 mm

## Möbelbeleuchtung Éclairages de meubles Iluminación de muebles



Energieklasse  
classe énergétique  
clase de energía



Wechselstromversorgung 220-240 V  
alimentation en tension alternative 220-240 V  
alimentación con corriente alterna 220-240 V



Gleichstromversorgung 12 V  
alimentation en tension constante 12 V  
alimentación con corriente continua 12 V



Spannung 12 V  
alimentation en tension 12 V  
alimentación con 12 V



Ausgangsspannung  
tension de sortie  
tensión de salida



Leistung des Leuchtmittels oder des Gerätes  
puissance de la source lumineuse ou de l'appareil  
potencia de la fuente de luz o del dispositivo



zulässige Höchstlast  
charge maximale autorisée  
carga máxima permitida



Strahlungswinkel  
angle de diffusion de la lumière  
ángulo de luz



Typ der Diode  
type de diode  
tipo de LED



Diодenanzahl  
nombre de diodes  
número de LEDs



Kabellänge  
longueur du câble  
largo del cable



Kabellänge mit Stecker  
longueur du câble avec fiche  
largo del cable con enchufe



Kabellänge mit Stecker  
longueur de câble avec raccord  
largo del cable con conector



Typ des Verbindungsstücks  
types de raccord  
tipo de conector



Typ des Verbindungsstücks  
types de raccord  
tipo de conector



Betriebstemperatur  
température de service  
temperatura de servicio



Typ des Verbindungsstücks  
types de raccord  
tipo de conector



USB-Buchse  
prise USB  
ranura USB



Schutzart IP  
degré de protection IP  
grado de protección IP



maximale Belastung der USB-Buchse  
courant maximal des ports USB  
carga máxima de los puertos USB



Farbwiedergabeindex  
indice de rendu des couleurs  
índice de reproducción cromática



UK-Steckdose  
prise UK  
enchufe UK



Leistungsfaktor  
facteur de puissance  
factor de potencia



Ethernet  
ethernet  
ethernet



Anzahl der Ein/Aus-Zyklen  
nombre de cycles d'entrée/sortie  
interruptor de contacto regulable



nicht dimmbar  
ne fonctionne pas avec les gradateurs  
no funciona con atenuadores



dimmbarer Berührungsschalter  
Interrupteur tactile avec gradateur  
número de ciclos de encendido/apagado



dimmbar  
fonctionne avec les gradateurs  
funciona con atenuadores



Leuchte mit Schalter  
luminaire avec interrupteur  
luminaria con interruptor



Wand-/Deckenmontage  
Application: Intérieur/ appliqué  
interior / fijación en techo



(IR/RF)-Fernbedienung  
télécommande (IR/RF)  
control con mando a distancia (IR/RF)



empfohlener Montageabstand von der Oberfläche  
distance d'installation recommandée par rapport à la surface  
distancia de montaje recomendada desde la superficie



Bewegungsschalter  
interrupteur sans contact bipolaire  
interruptor sin contacto doble



Durchmesser der Montageöffnung  
diamètre de l'ouverture du montage  
diámetro del orificio de montaje



Schranktürschalter  
interrupteur d'armoire / unipolaire  
interruptor de armario / simple



Akku  
accumulateur  
acumulador



Reichweite des Bewegungssensors  
Portée du capteur de mouvement  
alcance del detector de movimiento



Max. Belastung pro Weg  
Sortie Max: A/Canal  
Carga máxima por canal



Betriebszeit  
temps de travail  
tiempo de trabajo



Angenommene Frequenz  
Fréquence de Transmission  
Frecuencia del mando a distancia



Einschaltzeit  
durée de mise en marche  
tiempo de activación



Maximale Verlustleistung der Leuchtmittel für ein beheiztes Profil bis maximal 65°C für die Version mit Abdeckung.  
Puisissance dissipée maximale des sources de lumière pour profil chauffé jusqu'à un maximum de 65 degrés Celsius, pour versions avec diffuseur.  
Potencia máxima emitida por la fuente de iluminación, con el perfil calentado a una temperatura máxima de 65°C, para la versión con difusor.



Leuchtmittelsockel G4  
culot de la source lumineuse G4  
casquillo de la fuente de luz G4

FARBEN  
COULEURS  
COLORES



10  
weiß  
blanc  
blanco



80  
silberfarben  
argent  
plata



14  
Altkupfer  
cuivre ancien  
cobre envejecido



10M  
weiß matt  
blanc mat  
blanco mate



7  
Altsilber  
argent ancien  
plata envejecida



20  
schwarz  
noir  
negro



milchig  
laiteux  
leche



19  
grau-matt  
gris mat  
gris mate



20M  
schwarz matt  
noir mat  
negro mate



CS  
cremefarbig  
crème  
crema



2, 52  
Nickel matt  
satin  
satinado



58  
Wenge  
wengé  
wengué



1, 40  
Chrom  
chrome  
cromado



6, 51  
Edelstahloptik  
acier brossé  
acero cepillado



3  
Messing  
brunze  
latón



5, 53  
Aluminium  
aluminium  
aluminio



11  
gebürstetes Titan  
titane brossé  
titanio cepillado



4  
Altmessing  
laiton ancien  
latón envejecido



30  
grau  
gris  
gris



12  
Schwarzchrom  
chrome noir  
cromado negro



9  
Altmessing gebürstet  
laiton antique brossé  
latón antiguo cepillado



verzinkt  
galvanisé  
galvanizado



13  
Titan  
titane  
titanio



16  
Gold Messing  
laiton doré  
latón dorado



22  
Elfenbein  
ivoire  
marfil



52  
Kirschbaum  
cerise  
cerezo



RZ  
rosa  
rose  
rosa



17  
braun  
brun  
marrón



42  
Birnbäum  
poire  
peral



PM  
orangerfarben  
orange  
naranja



50  
beige  
beiges  
beige



30  
braun  
brunze  
marrón



15  
Kupfer  
cuivre  
cobre



7, 31, 732  
dunkelbraun  
brun laiteux  
marrón oscuro



44  
Buche  
hêtre  
haya



61  
Mahagoni, dunkel  
acajou foncé  
caoba oscuro



41  
Erle  
aulne  
aliso



20, 48, 731  
Mahagoni  
acajou  
caoba



43  
hellbraun  
brun clair  
marrón claro



NB  
blau  
bleu  
azul



51  
Calvados  
calvados  
calvados



ZL  
grün  
vert  
verde

**Schutzart gegen Staub, Feststoffe und Wasser**  
**Classe de protection pour la poussière, les solides et l'eau**  
**Clase de protección contra polvo, sólidos y agua**



IP	Schutzart I Degré de protection I Grado de protección I
0	Kein Schutz Absence de protection Sin protección
1	Schutz gegen Fremdkörper mit einem Durchmesser von über 50 mm Protection contre les corps étrangers solides de plus de 50 mm. Protección contra objetos sólidos extraños de más de 50 mm de tamaño
2	Schutz gegen Fremdkörper mit einem Durchmesser von über 12 mm Protection contre les corps solides de plus de 12 mm. Protección contra objetos sólidos de más de 12 mm
3	Schutz gegen Fremdkörper mit einem Durchmesser von über 2,5 mm Protection contre les corps solides de plus de 2,5 mm. Protección contra objetos sólidos de más de 2,5 mm
4	Schutz gegen Fremdkörper mit einem Durchmesser von über 1 mm Protection contre les corps solides de plus de 1 mm. Protección contra objetos sólidos de más de 1 mm
5	Schutz gegen Staub Résistance à la poussière Resistencia al polvo
6	Staubdicht Résistance à la poussière Impermeabilidad al polvo

IP	Schutzart II Degré de protection II Grado de protección II
0	Kein Schutz Absence de protection Sin protección
1	Schutz gegen senkrecht fallende Wassertropfen Protection contre les gouttes d'eau tombant verticalement. Protección contra la caída vertical de gotas de agua.
2	Schutz gegen Wassertropfen bei einer Neigung bis 15°. Protection contre les gouttelettes d'eau jusqu'à 15 ° d'inclinaison. Protección contra gotas de agua con una inclinación de hasta 15°.
3	Schutz gegen Sprühwasser Protection contre les projections d'eau Protección contra proyecciones de agua
4	Schutz gegen Spritzwasser Protection contre les éclaboussures d'eau. Protección contra salpicaduras de agua
5	Schutz gegen Wasserstrahl Protection contre les jets d'eau Protección contra chorros de agua
6	Schutz gegen Wasserwellen Protection contre les vagues Protección contra olas
7	Schutz gegen Untertauchen Protection contre l'immersion Protección contra inmersión
8	Schutz gegen tiefes Untertauchen Protection contre l'immersion profonde Protección contra inmersión profunda

# Schutzklasse gegen elektrischen Schlag

## Classe de protection contre les chocs électriques

### Clase de protección contra descargas eléctricas

Sicherheit- sklasse Classe de sécurité Clase de seguridad	Symbol Symbole Símbolo	Erläuterung Explication Explicación
<b>0</b>	Kein Schutz  Aucun  Falta	<p>Den Schutz gegen elektrischen Schlag bildet die Grundisolierung. Bei Beschädigung der Isolierung sollte der Berührungsschutz durch geeignete günstige Umweltbedingungen und die Platzierung des Geräts außerhalb des direkten Kontakts gewährleistet werden.</p> <p>La protection contre les chocs électriques est assurée par l'isolation de base. En cas d'endommagement de l'isolation, la protection contre les chocs électriques doit garantir des conditions environnementales appropriées et que l'appareil soit en dehors d'un contact direct.</p> <p>La protección contra descargas eléctricas se proporciona mediante aislamiento básico. En caso de daños en el aislamiento, la protección contra descargas eléctricas garantizará unas condiciones ambientales adecuadas y la ubicación del dispositivo fuera del contacto directo.</p>
<b>I</b>		<p>Bei Geräten der Schutzklasse I wird die Sicherheit durch die Verbindung aller aktiven Leiterelemente mit dem Schutzleiter oder direkt mit der Erdung sichergestellt.</p> <p>Pour les équipements de la 1re classe de protection, la sécurité est garantie par la connexion de tous les éléments conducteurs avec le conducteur de protection ou directement avec la mise à la terre.</p> <p>En los dispositivos con clase de protección I, la seguridad se garantiza conectando todos los elementos conductores activos al conductor de protección o directamente a tierra.</p>
<b>II</b>		<p>Bei Geräten der Schutzklasse II wird die Sicherheit durch den Einsatz von doppelter oder verstärkter Isolierung, die bei gegebenen Umweltbedingungen und der Nennspannung als durchschlagfest angesehen werden, sichergestellt.</p> <p>Pour les équipements de la IIe classe de protection, la sécurité est assurée grâce à une double isolation ou une isolation renforcée, qui dans les conditions environnementales données et pour la tension nominale ne claquent pas.</p> <p>En los dispositivos con clase de seguridad II, la seguridad está garantizada por el uso de aislamiento doble o reforzado, que se considera insuperable en las condiciones ambientales dadas y a la tensión nominal.</p>
<b>III</b>		<p>Der Schutz gegen elektrischen Schlag bei Schutzeinrichtungen der Klasse III wird durch Absenken der Versorgungsspannung auf das unter den gegebenen Umweltbedingungen sichere Niveau gewährleistet.</p> <p>La protection contre choc électrique dans les équipements de IIIe classe de protection est garantie par la réduction de la tension d'alimentation jusqu'à la valeur sûre dans les conditions environnementales données.</p> <p>La protección contra descargas eléctricas en dispositivos de clase III se garantiza reduciendo la tensión de alimentación al valor seguro en las condiciones ambientales dadas.</p>

# Indeks

## A

		AE-PB1SAVA-20	636	AE-WDBP1-20	608	A-HRS18-405-05	528
		AE-PB1SAVA-53	636	AE-WDBP2CCT-10	608	A-HRS18-405-90	528
A-B63-32	538	AE-PB1SAVAP-10	634	AE-WDBP2CCT-20	608	A-HRS18-600-05	528
A-B63-40	537	AE-PB1SAVAP-20	634	AE-WDSB-10DIM	613	A-HRS18-600-90	528
A-BUD-K-UB	544	AE-PB1SAVAP-53	634	AE-WDSC-10DIM	613	A-K18-300-05	525
A-BUDP-SET	544	AE-PB2FPRES-10	626	AE-WLB01-10	615	A-K18-300-10	525
A-BUD-UM	544	AE-PB2FPRES-20	626	AE-WLC01-20	615	A-K18-300-20M	525
A-BUD-UP	544	AE-PB2FPRES-53	626	AE-WLIP44-15	616	A-K18-300-90	525
A-BUD-UR	544	AE-PB2SPRES-10	626	AE-WLLAN1-10	617	A-KLP-4	536
A-C18-300-S-05	526, 541, 542	AE-PB2SPRES-20	626	AE-WLLAN1-20	617	A-KLP-4-20	536
A-C18-300-S-10	526	AE-PB2SPRES-53	626	AE-WLLAN1-90	617	A-KR-4	535
A-C18-300-S-20M	526	AE-PB03GS-10	643	AE-WLPR-60	615	A-KR-4-20	535
A-C18-300-S-90	526	AE-PB03GS-20	643	AE-WLPR-60P2	615	A-LD4MOV-300-05	524
A-DPG-16	531	AE-PB03GS-53	643	AE-WLSZN1-10	617	A-LD10-170-05	523
AE-BPW1FACP-10	628	AE-PB03GU-53	643	AE-WPDRW-00	614	A-LD10-235-05	523
AE-BPW1FACP-20	628	AE-PBC3GS2U-53BKS	646	AE-ZLADLUX-40	624	A-LD10-235-90	523
AE-BPW1S1UCH-53	639	AE-PBC3GS-51BK	646	AE-ZLADPOD-20	624	A-LD10-300-05	523
AE-BPW1S1UCH-53	638	AE-PBC3GS-53BKS	646	AE-ZUSB-20	623	A-LD10-300-10	523
AE-BPW1S2UCH-80	638	AE-PBC3GU-10	643	A-H16-300-05	526	A-LD10-300-20M	523
AE-BPW1SACP-10	628	AE-PBC3GU-20	643	A-H16-300-90	526	A-LD10-300-90	523
AE-BPW1SACP-20	628	AE-PBC3GU-51BK	646	A-H18-300-05	527	A-LD10-405-05	523
AE-BPW1U1UCH-53	639	AE-PBC3GU-53	643	A-H18-300-10	527	A-LD10-405-90	523
AE-BPW1U1UCH-53	638	AE-PBK13S2U-80	647	A-H18-300-20M	527	A-LD10-600-05	523
AE-BPW1U2UCH-80	638	AE-PBK13U2U-80	647	A-H18-300-90	527	A-LD10-600-90	523
AE-BPW2FCAM-10	632	AE-PBK14S-80	647	A-HR10-235-05	529	A-LD10FL-300-05	525
AE-BPW2FCAM-20	632	AE-PBK14U-80	647	A-HR10-235-90	529	A-LD10FL-300-10	525
AE-BPW2SCAM-10	632	AE-PBSC3GS-10	644	A-HR10-300-05	529	A-LD10FL-300-20M	525
AE-BPW2SCAM-20	632	AE-PBSC3GS-20N	644	A-HR10-300-10	529	A-LD10FL-300-90	525
AE-BPW3GS-20	640	AE-PBSC3GS-53	644	A-HR10-300-90	529	A-LD18-170-05	521
AE-BPW3GS-80	640	AE-PBSC3GU-10	644	A-HR10-405-05	529	A-LD18-170-90	521
AE-BPW3GU-20	640	AE-PBSC3GU-20N	644	A-HR10-405-90	529	A-LD18-235-05	521
AE-BPW3GU-80	640	AE-PBSC3GU-53	644	A-HR10-600-05	529	A-LD18-235-90	521
AE-BPW3S60-20	642	AE-PBSUC2GS-10	644	A-HR10-600-90	529	A-LD18-300-05	521
AE-BPW3S60-80	642	AE-PBSUC2GS-20N	644	A-HR10FL-300-05	529	A-LD18-300-10	521
AE-BPW3S60U-20	642	AE-PBSUC2GS-53	644	A-HR10FL-300-10	529	A-LD18-300-20M	521
AE-BPW3S60U-80	642	AE-PBSUC2GU-10	644	A-HR10FL-300-20M	529	A-LD18-300-90	521
AE-BPW3S100U-53	639	AE-PBSUC2GU-20N	644	A-HR10FL-300-90	529	A-LD18-405-05	521
AE-BPW3U60-20	642	AE-PBSUC2GU-53	644	A-HR18-300-05	528	A-LD18-405-10	521
AE-BPW3U60-80	642	AE-PBU02GS-10	643	A-HR18-300-05RA	527	A-LD18-405-90	521
AE-BPW3U60U-20	642	AE-PBU02GS-20	643	A-HR18-300-10	528	A-LD18-600-05	521
AE-BPW3U60U-80	642	AE-PBU2GU-10	643	A-HR18-300-20M	528	A-LD18-600-90	521
AE-BPW3U100U-53	639	AE-PBU2GU-20	643	A-HR18-300-90	528	A-LD19-300-05	522
AE-BPW4F120P-10	630	AE-PBU2GU-53	643	A-HR18-300-90RA	527	A-LG4MOV-300-05	523
AE-BPW4F120P-20	630	AE-WBBUNI-10DIM	612	A-HR19-300-05	528	A-LG10-170-05	522
AE-BPW4S100-53	639	AE-WBCUNI-10DIM	612	A-HRS10-170-05	529	A-LG10-235-05	522
AE-BPW4S120P-10	630	AE-WBE1-10	612	A-HRS10-300-05	529	A-LG10-235-90	522
AE-BPW4S120P-20	630	AE-WBE1-20	612	A-HRS10-300-90	529	A-LG10-300-05	522
AE-BPW4U100-53	639	AE-WBE2-10	613	A-HRS10-405-05	529	A-LG10-300-10	522
AE-PB1FAVA-10	636	AE-WBE2-20	613	A-HRS10-600-05	529	A-LG10-300-20M	522
AE-PB1FAVA-20	636	AE-WBEZDB-10S	610	A-HRS18-170-05	528	A-LG10-300-90	522
AE-PB1FAVA-53	636	AE-WBEZDC-10S	610	A-HRS18-170-90	528	A-LG10-405-05	522
AE-PB1FAVAP-10	634	AE-WBEZDK15-10	610	A-HRS18-235-05	528	A-LG10-405-90	522
AE-PB1FAVAP-20	634	AE-WBEZDPIR2-20	611	A-HRS18-235-90	528	A-LG10-600-05	522
AE-PB1FAVAP-53	634	AE-WBEZDPIR-10	611	A-HRS18-300-05	528	A-LG10-600-90	522
AE-PB1SAVA-10	636	AE-WDBP1-10	608	A-HRS18-300-90	528	A-LG10FL-300-05	524



A-LG10FL-300-10	524	AM-OWM-DL-MG-10	110, 111	A-R10TORO-270-90	516	A-SO-R-145X4-20	534
A-LG10FL-300-20M	524	AM-OWM-DL-MG-30	110	A-R10TRAFO-270-05	515	A-SP-R-7X12	535
A-LG10FL-300-90	524	AM-OWM-DL-MG-60	110	A-R10TRAFO-270-90	515	A-SP-R-48X7	534
A-LG18-170-05	520	AM-OWM-KR-GM-10	110	A-R16ERG-220-05	510	A-SP-R-48X12	535
A-LG18-170-90	520	AM-OWM-KR-GM-30	110	A-R16ERG-230-50	510	A-T18-300-05	526
A-LG18-235-05	520	AM-OWM-KR-GM-60	110	A-R16ERG-270-50	510	A-T18-300-10	526
A-LG18-235-90	520	AM-OWM-KR-MG-10	110	A-R16ERG-270-90	510	A-T18-300-20M	526
A-LG18-300-05	520	AM-OWM-KR-MG-30	110	A-R18CARO-270-05	512	A-T18-300-90	526
A-LG18-300-10	520	AM-OWM-KR-MG-60	110	A-R18CARO-270-90	512	A-TDEVO2-170-05	519
A-LG18-300-20M	520	AM-PLA-DLU-0	111	A-R18COTE-270-05	513	A-TDEVO2-170-90	519
A-LG18-300-90	520	AM-PL-DL-MAG	111	A-R18COTE-270-90	513	A-TDEVO2-235-05	519
A-LG18-405-05	520	A-MPRO-170-05	520	A-R18ERG-270-05	510	A-TDEVO2-235-90	519
A-LG18-405-10	520	A-MPRO-170-10	520	A-R18ERG-270-20M	510	A-TDEVO2-300-05	519
A-LG18-405-90	520	A-MPRO-170-20M	520	A-R18ERG-270-90	510	A-TDEVO2-300-90	519
A-LG18-600-05	520	A-MPRO-170-90	520	A-R18GE02-270-05	510	A-TDEVO2-405-05	519
A-LG18-600-90	520	A-MPRO-235-05	520	A-R18LOCA-305-05	514	A-TDEVO2-405-90	519
A-LG19-300-05	521	A-MPRO-235-10	520	A-R18LOCA-305-90	514	A-TDEVO2-600-05	519
AM-ADAP0A-10	109	A-MPRO-235-20M	520	A-R18NERO-270-05	513	A-TDEVO2-600-90	519
AM-ADAP0A-60	109	A-MPRO-235-90	520	A-R18NERO-270-10	513	A-TDEVO-170-05	518
AM-ADAP0B-10	109	A-MPRO-300-05	520	A-R18NERO-270-20M	513	A-TDEVO-170-10	518
AM-ADAP0B-60	109	A-MPRO-300-10	520	A-R18NERO-270-90	513	A-TDEVO-170-20M	518
A-MEVO-170-05	518	A-MPRO-300-20M	520	A-R18NOVS-270-05	511	A-TDEVO-170-90	518
A-MEVO-170-10A	518	A-MPRO-300-90	520	A-R18NOVS-270-10	511	A-TDEVO-235-05	518
A-MEVO-170-20M	518	A-MPRO-405-05	520	A-R18NOVS-270-20M	511	A-TDEVO-235-10	518
A-MEVO-170-90	518	A-MPRO-405-10	520	A-R18NOVS-270-90	511	A-TDEVO-235-20M	518
A-MEVO-235-05	518	A-MPRO-405-20M	520	A-R18VIS-270-05	512	A-TDEVO-235-90	518
A-MEVO-235-10A	518	A-MPRO-405-90	520	A-R18VIS-270-20M	512	A-TDEVO-300-05	518
A-MEVO-235-20M	518	AMR-BP-0715	113	A-R18VIS-270-90	512	A-TDEVO-300-10	518
A-MEVO-235-90	518	AMR-BP-1003	113	A-R19NERO-300-05	513	A-TDEVO-300-20M	518
A-MEVO-300-05	518	A-MSOFT-ADAPT	539	A-R19NOVS-300-05	512	A-TDEVO-300-90	518
A-MEVO-300-10A	518	A-MSOFT-RAMA	538	A-RD-MITO	540	A-TDEVO-405-05	518
A-MEVO-300-20M	518	AM-ZAT-A1-10	113	A-RNOV2-270-05	511	A-TDEVO-405-10	518
A-MEVO-300-90	518	A-PG-18	530	A-RNOV2-270-10	511	A-TDEVO-405-20M	518
A-MEVO-405-05	518	A-PGR-10	530	A-RNOV2-270-20M	511	A-TDEVO-405-90	518
A-MEVO-405-10	518	A-PGR-10S	531	A-RNOV2-270-90	511	A-TDEVO-600-05	518
A-MEVO-405-20M	518	A-PGR-18	530	A-SG-MITO	540	A-TDEVO-600-10	518
A-MEVO-405-90	518	A-POZ-MITO	540	A-SN-ADSET	541, 542	A-TDEVO-600-20M	518
A-MITO-PLUS	540	A-PTD	533	A-SN-FSET	541	A-TDEVO-600-90	518
AM-KRZYZ-KPL	108	A-PTG	533	A-SN-HSET1	542	A-TDPRO-170-05	519
AM-MBSOFT-P2	165	A-PW-RC-DOC	539	A-SN-K19-270-05	541, 542	A-TDPRO-170-10	519
AM-OAM-DL-GM-10	112	A-R4MOV-270-05	514	A-SN-LOFT-200-20MN	545	A-TDPRO-170-20M	519
AM-OAM-DL-GM-30	112	A-R10ARCO-270-05	516	A-SN-POZ	542	A-TDPRO-170-90	519
AM-OAM-DL-GM-60	112	A-R10ARCO-270-90	516	A-SN-R19RIV-270-05	541, 542	A-TDPRO-235-05	519
AM-OAM-DL-MG-10	112	A-R10FALDA-270-05	516	A-SN-SDP-TU	543	A-TDPRO-235-10	519
AM-OAM-DL-MG-30	112	A-R10FALDA-270-20M	516	A-SN-SOFT-25Z	541, 542	A-TDPRO-235-20M	519
AM-OAM-DL-MG-60	112	A-R10FALDA-270-90	516	A-SN-SOFT-40Z	541, 542	A-TDPRO-235-90	519
AM-OAM-KR-GM-10	112	A-R10FL-270-05	514	A-SN-TDS-405-00	541	A-TDPRO-300-05	519
AM-OAM-KR-GM-30	112	A-R10FL-270-10	514	A-SN-TDT-405-00	542	A-TDPRO-300-10	519
AM-OAM-KR-GM-60	112	A-R10FL-270-20M	514	A-SN-TG-405-00	541, 542	A-TDPRO-300-20M	519
AM-OAM-KR-MG-10	112	A-R10FL-270-90	514	A-SOFT-30	538	A-TDPRO-300-90	519
AM-OAM-KR-MG-30	112	A-R10FORM-270-05	515	A-SOFT-30Z	538	A-TDPRO-405-05	519
AM-OAM-KR-MG-60	112	A-R10FORM-270-90	515	A-SOFT-50	538	A-TDPRO-405-10	519
AM-ODB000-10	108	A-R10NOV-270-05	515	A-SOFT-50Z	538	A-TDPRO-405-20M	519
AM-ODB000-60	108	A-R10NOV-270-10	515	A-SO-R-48X4	534	A-TDPRO-405-90	519
AM-OWM-DL-GM-10	110	A-R10NOV-270-20M	515	A-SO-R-48X4-20	534	A-TDPRO-600-05	519
AM-OWM-DL-GM-30	110	A-R10NOV-270-90	515	A-SO-R-145X4	534	A-TDPRO-600-10	519
AM-OWM-DL-GM-60	110	A-R10TORO-270-05	516	A-SO-R-145X4-10	534	A-TDPRO-600-20M	519

A-TDPRO-600-90	519	GP-0728-J4-C-04	416	GZ-TERNI-1-01	348, 378	KK-W60800-24	335
A-TG-170-05	517	GP-0728-J4-R	416	GZ-TERNI-1-02	378	KK-W60800-M0	335
A-TG-170-10	517	GS-BERGA-1-01	377	GZ-TERNI-1-05	378	KK-W60800-M1	335
A-TG-170-20M	517	GS-BERGA-1-02	377	GZ-TERNI-1-06	378	KK-W60800-M2	335
A-TG-170-90	517	GS-BERGA-1-05	377	GZ-TERNI-1-09	378	KK-W80480-05	336
A-TG-235-05	517	GS-BERGA-1-06	377	GZ-TERNI-1-10	378	KK-W80480-06	336
A-TG-235-10	517	GS-BERGA-1-10	377	GZ-TERNI-1-12	378	KK-W80480-10	336
A-TG-235-20M	517	GS-BERGA-1-12	377	GZ-TERNI-1-15	378	KK-W80480-20M	336
A-TG-235-90	517	GS-BERGA-1-20M	377	GZ-TERNI-1-16	378	KK-W80480-21	336
A-TG-300-05	517	GS-BERGA-1-90	377	GZ-TERNI-1-20M	378	KK-W80480-24	336
A-TG-300-10	517	GZ-ARDEA-1-09	425	GZ-UDINE-1-01	378	KK-W80800-06	335
A-TG-300-20M	517	GZ-CENTO-1-04	421	GZ-UDINE-1-02	378	KK-W80800-21	335
A-TG-300-90	517	GZ-CENTO-1-07	421	GZ-UDINE-1-05	378	KK-W80800-24	335
A-TG-405-05	517	GZ-CENTO-1-14	421	GZ-UDINE-1-06	378	KK-W80800-D0	335
A-TG-405-10	517	GZ-CENTO-1-20M	421	GZ-UDINE-1-10M	378	KK-W80800-D1	335
A-TG-405-20M	517	GZ-CRPA20-01	433	GZ-UDINE-1-12N	378	KK-W80800-D2	335
A-TG-405-90	517	GZ-CRPA25-01	433	GZ-UDINE-1-20M	378	KM-00-40-D20	500
A-TG-600-05	517	GZ-CRPA30-01	433	GZ-VENICE-1-20M	366	KM-00-50-D20	500
A-TG-600-10	517	GZ-CRPA30-03	433	GZ-VENICE-1-90	366	KM-0H-40-D20	500
A-TG-600-20M	517	GZ-CRPA30-A1	433	GZ-WP1136-04	430	KM-0H-50-D20	500
A-TG-600-90	517	GZ-CRPA40-01	433	GZ-WP1148-04	431	KM-015030-10	500
A-TG-BUD-200-00	544	GZ-CRBP20-01	433	GZ-WP1152-04	431	KM-015030-20	500
A-TG-BUD-300-00	544	GZ-CRBP25-01	433	GZ-WP1155-01	388	KM-015038-10	500
A-TMITO-200-00	540	GZ-CRBP25-A1	433	GZ-ZH-011-05A	388	KM-015038-GM	501
A-TMITO-200-05	540	GZ-CRBP30-01	433			KM-A035MM-00	501
A-TMITO-250-00	540	GZ-CRBP30-03	433			KM-A035MM-30	501
A-TMITO-250-05	540	GZ-CRBP30-A1	433			KM-A050MM-00	502
A-TMITO-300-00	540	GZ-CRBP40-01	433			KM-A050MM-30	502
A-TMITO-300-05	540	GZ-CRBP40-A1	433			KM-AH35MM-00	501
A-USZCZ-CHM4	537	GZ-CRPC30-01	434			KM-AH35MM-30	501
A-USZCZ-CHM4-20	537	GZ-LORENA-1-03	373	ID-GZ-CRPJ30-01	434	KM-AH50MM-00	502
A-USZCZ-TDEVO2	537	GZ-LORENA-1-18	373	ID-RS-E-15696-20M	390	KM-AH50MM-30	502
A-USZCZ-U4	536	GZ-LORENA-1-20M	373	ID-RS-E-188128-20M	390	KM-B050MM-00	502
A-WD-EVO2	531	GZ-LORENA-1-21	373	ID-RS-E-220160-06	390	KM-B050MM-30	502
A-WD-PRO	532	GZ-MILAN-32-20M	354	ID-RS-E-220160-20M	390	KM-B075MM-00	503
A-WDR-EVO	532	GZ-NORD-1-03	364	ID-RS-E-272192-06	390	KM-B075MM-30	503
A-WDR-PRO	533	GZ-NORD-1-18	364	ID-RS-E-272192-20M	390	KM-BH50MM-00	502
A-ZAC-WDEVO2	532	GZ-NORD-1-20M	364	ID-RS-E-304224-06	390	KM-BH50MM-30	502
A-ZAT-TDEVO2	536	GZ-OLBIA-1-04	424	ID-RS-E-304224-20M	390	KM-BH75MM-00	503
		GZ-PALER-1-07	424	ID-RS-E-336256-06	390	KM-BH75MM-30	503
		GZ-PIAZZA-1-03	349	ID-RS-E-336256-20M	390	KM-GREYROLL-50mm-BH	505
BP-SLZIGW-10	477	GZ-PIAZZA-1-06	349	ID-RS-E-368288-06	390	KM-GREYROLL-50mm-ZH	505
BP-SLZIGW-21	477	GZ-PIAZZA-1-18	349	ID-RS-E-368288-20M	390	KM-GREYROLL-75mm-BH	505
		GZ-PIAZZA-1-20M	349	ID-RS-E-400320-06	390	KM-GREYROLL-75mm-ZH	505
		GZ-POINT-1-06	372	ID-RS-E-400320-20M	390	KM-RD-35-CF	503
		GZ-POINT-1-18	372			KM-RD-35-CF-20	503
EM-SBL065-01-A	246	GZ-RING-1-18	368			KM-RD-35-SF	503
EM-SBL100-01-A	246	GZ-RING-1-20M	368	KK-D50-80-06	334	KM-RD-35-SF-20	503
EM-SBL150-01-A	246	GZ-ROYAL3-1-10-03	429	KK-D50100-06	334	KM-RD-50-CF	504
		GZ-SONET-1-07	423	KK-W60245-21	333	KM-RD-50-CF-20	504
GA-IMPER-1-02B	422	GZ-SONET-1-18	423	KK-W60245-24	333	KM-RD-50-CF-20	504
GA-IMPER-1-11	422	GZ-SONET-1-20M	423	KK-W60245-M0	333	KM-RD-50-SF	504
GA-IMPER-1-20M	422	GZ-SPOT-1-03	345	KK-W60245-M1	333	KM-RD-50-SF-20	504
GA-STRUCTURE-1-20M	379	GZ-SPOT-1-06	345	KK-W60245-M2	333	KM-RD-75-CF	504
GP-0728-J4-A-04	416	GZ-SPOT-1-10	345	KK-W60245-M6	333	KM-RD-75-CF-20	504
GP-0728-J4-A-07	416	GZ-SPOT-1-18	345	KK-W60800-06	335	KM-RD-75-SF	504
GP-0728-J4-B	416	GZ-SPOT-1-20M	345	KK-W60800-21	335	KM-RD-75-SF-20	504
						KM-SPAIN-40MM-18	505

KM-SPAIN-50MM-18	505	LB-80X160-20	323	LD-3528-600-20-ZB-50	552	LD-PIRUSB-53	594
KO-150BO-01	308	LB-80X280-05	323	LD-3528-600-65-CB	550	LD-RA60CB-40N	593
KO-150BO-01B	308	LB-80X280-20	323	LD-3528-600-65-NE4	550	LD-RA60ZB-40N	593
KO-150BO-60	308	LB-80X500-05	324	LD-3528-600-65-ZB	550	LD-RGB-150-20	551
KO-150BO-E-01	311	LB-80X500-20	324	LD-5050-300-20-CB	551	LD-RGB-150-65	551
KO-200BO-01	308	LB-K80X80-05	322	LD-5050-300-20-NE4	551	LD-RGBW-300-20	551
KO-200BO-01B	308	LB-K80X80-20	322	LD-5050-300-20-NE4-50	552	LD-TR24CB-53	591
KO-200BO-60	308	LD-35KL-ZBN	595	LD-5050-300-20-ZB	551	LD-TR24NE-53	591
KO-200BO-E-01	311	LD-2835-24V-300-20-CB	552	LD-5050-300-65-CB	551	LD-TR24ZB-53	591
KO-300BO-01	310	LD-2835-24V-300-20-NE4	552	LD-5050-300-65-NE4	551	LD-UNF-12V6X12-6X	555
KO-300BO-01B	310	LD-2835-24V-300-20-ZB	552	LD-5050-300-65-ZB	551	LD-VA24CB-53	588
KO-300BO-60	310	LD-2835-24V-600-20-CB	552	LD-5630-300-20-CB	551	LD-VA24NE-53	588
KO-400BO-01	310	LD-2835-24V-600-20-NE4	552	LD-5630-300-20-NE4	551	LD-VE15CB-53N	590
KO-400BO-01B	310	LD-2835-24V-600-20-ZB	552	LD-5630-300-20-NE4-50	552	LD-VE15CBZB-53N	591
KO-400BO-60	310	LD-2835-60-60-20-CCT	551	LD-5630-300-20-ZB	551	LD-VE15NE-53N	590
KO-500BO-01	310	LD-2835-300-20-CB	550	LD-5630-300-65-CB	551	LD-VE15ZB-53N	590
KO-500BO-01B	310	LD-2835-300-20-CB-50	552	LD-5630-300-65-NE4	551	LD-WA20W-NW	599
KO-500BO-60	310	LD-2835-300-20-CBN	550	LD-5630-300-65-ZB	551	LD-WZA36W-NW	599
KO-SR100-30-10	287	LD-2835-300-20-NE4N	550	LD-AL24CB-53	590	LD-WZA60W-NW	599
KO-SR100-40-10	287	LD-2835-300-20-NE4P	550	LD-AL24NE-53	590	LD-WZA80W-NW	599
KO-SR100-50-10t	287	LD-2835-300-20-NE4P-50	552	LD-AL24ZB-53	590	LD-WZA150W-NW	599
KO-SR100-60-10	287	LD-2835-300-20-ZB	550	LD-BOS1CBWG-53	594	LD-ZAC6WDE-RGB	601
KO-SR150-30-10	287	LD-2835-300-20-ZB-50	552	LD-COB12V-20-CBN	554	LD-ZAS09WEC-30	595
KO-SR150-40-10	287	LD-2835-300-20-ZBN	550	LD-COB12V-20-CBPQ	554	LD-ZAS15WEC-30	595
KO-SR150-50-10	287	LD-2835-300-65-CB	550	LD-COB12V-20-NEN	554	LD-ZAS20WEC-30	595
KO-SR150-60-10	287	LD-2835-300-65-CBN	550	LD-COB12V-20-NEPQ	554	LD-ZAS24PRO16W-30	596
KO-SR200-30-10	287	LD-2835-300-65-NE4	550	LD-COB12V-20-ZBN	554	LD-ZAS24PRO033W-30	596
KO-SR200-40-10	287	LD-2835-300-65-NE4N	550	LD-COB12V-20-ZBPQ	554	LD-ZAS24PRO54W-30	596
KO-SR200-50-10	287	LD-2835-300-65-ZB	550	LD-COB24V-20-CBN	554	LD-ZAS24PRO080W-30	596
KO-SR200-60-10	287	LD-2835-300-65-ZBN	550	LD-COB24V-20-NEN	554	LD-ZAS30WEC-30	595
KO-UMC450-01	307	LD-2835-600-5MM-20-CB	551	LD-COB24V-20-ZBN	554	LD-ZAS60WEC-30	595
KO-UMC450-01B	307	LD-2835-600-5MM-20-NE4	551	LD-CS36CB-53	589	LD-ZAS75W-30	596
KO-UMC450-60	307	LD-2835-600-5MM-20-ZB	551	LD-CS36NE-53	589	LD-ZAS150-NW	598
KO-WMC450-01	306	LD-2835-600-20-CB	550	LD-CS36ZB-53	589	LD-ZAS350-NW	599
KO-WMC450-01B	306	LD-2835-600-20-NE4	550	LD-DIMLED-10	616	LD-ZASNF-12V6X12-65	555
KO-WMC450-60	306	LD-2835-600-20-ZB	550	LD-IRUSB-53	594	LD-ZASPRO07W-30	598
KO-WMC500-01	306	LD-2835-600-65-CB	550	LD-KABE2M-00	618	LD-ZASPRO12W-30	598
KO-WMC500-01B	306	LD-2835-600-65-NE4	550	LD-KLPCB-00N	595	LD-ZASPRO16W-30	598
KO-WMC500-60	306	LD-2835-600-65-ZB	550	LD-KLPNB-00N	595	LD-ZASPRO24W-30	598
KT-WP1147-04	432	LD-3014-1200-20-CB	551	LD-KLPZB-00N	595	LD-ZASPRO33W-30	598
KW-FS0125-01	238	LD-3014-1200-20-NE4	551	LD-KONMINI-RGB	602	LD-ZASPRO54W-30	598
KW-FS0140-01	238	LD-3014-1200-20-ZB	551	LD-KONML-MONO	603	LD-ZASPRO65W-30	598
KW-FS0335-01	239	LD-3528-300-20-CB	550	LD-KONML-MONO-PAN	604	LD-ZASPRO80W-30	598
KW-FS0350-01	239	LD-3528-300-20-CB-50	552	LD-KONML-MONO-PIL	603	LD-ZASPU15W-30N	600
KW-FS0375-01	239	LD-3528-300-20-NE4P	550	LD-KONML-RGBW	604	LD-ZL5RGB150-00	553
KW-FS0425-03	239	LD-3528-300-20-NE4P-50	552	LD-KONML-RGBW-PIL	605	LD-ZSKL15-00N	600
KW-FS0450-03	239	LD-3528-300-20-NI	550	LD-KONML-WIFI	606	LD-ZTK8-COB	620
KW-FS0650-01	240	LD-3528-300-20-ZB	550	LD-KONML-WRGB-PAN	605	LD-ZTK8MM-02N600	622
		LD-3528-300-20-ZB-50	552	LD-KWP27CB-53	593	LD-ZTK10MM-02N	622
		LD-3528-300-65-CB	550	LD-LU16CB-53	588	LD-ZTKS8MM-02N	622
LB-51X180-05	324	LD-3528-300-65-NE4	550	LD-LU16NE-53	588	LD-ZTKT8MM-02N600	621
LB-51x180-20	324	LD-3528-300-65-ZB	550	LD-LU16ZB-53	588	LD-ZTKT10MM-02N	621
LB-51X450-05	324	LD-3528-600-20-CB	550	LD-NF12V6x12-65-CB	555	LD-ZTKTRGB-04N	621
LB-51x450-20	324	LD-3528-600-20-CB-50	552	LD-NF12V6x12-65-NE	555	LD-ZTL8-COB	620
LB-80X100-05	322	LD-3528-600-20-NE4	550	LD-NF12V6x12-65-ZB	555	LD-ZTL8MM-02N600	621
LB-80X100-20	322	LD-3528-600-20-NE4-50	552	LD-OBP27CB-53	592	LD-ZTL10MM-02N	621
LB-80X160-05	323	LD-3528-600-20-ZB	550	LD-OBP27ZB-53	592	LD-ZTL82MAMP-COB	620

LD-ZTL82M-COB	620	MM-FI20X6X7-PL80-A-1T	246	MR-WP2806-01	267	NM-A80870-10	486
LD-ZTLR6B-04N	621	MM-FI20X6X7-ZN-A-1T	246	MR-WP2807-20	268	NM-A80870-20	486
LD-ZTL88MM-02N	622	MP-054350-10	163	MR-WP2815-01	266	NM-A80870-80	486
LD-ZTL88MMAMP-02N	622	MP-054400-10	163	MR-WPS01-001	269	NM-ARTO-10-2R304-20M	493
LD-ZTL82M-2N	622	MP-054450-10	163	MR-WPS03-001	269	NM-ARTO-10-2R406-20M	493
LD-ZWN6W-10	601	MP-054450-80	163	MR-WP2002-01	257	NM-ARTO-10-2R711-20M	493
LD-ZWN012-10	601	MP-054500-10	163	MR-WP2003-01	257	NM-ARTO-10-3R304-20M	492
LD-ZZAS12PROKD6	597	MP-054500-80	163	MR-WP2023-01	268	NM-ARTO-10-3R406-20M	492
LD-ZZAS16PROKD6	597	MP-086270-10	163	MR-ZSL011-01	233	NM-ARTO-10-3R711-20M	492
LD-ZZAS24PROKD6	597	MP-086300-10	163			NM-ARTO-12-2R304-20M	493
LD-ZZAS33PROKD6	597	MP-086350-10	163			NM-ARTO-12-2R406-20M	493
LD-ZZASG18KWD6	600	MP-086350-80	163	<b>N</b>		NM-ARTO-12-2R711-20M	493
LMB-BOCZ38L-05	251	MP-086400-10	163	NM-46R710-05	498	NM-ARTO-12-3R304-20M	492
LMB-BOCZ38L-20M	251	MP-086400-80	163	NM-46R820-05	498	NM-ARTO-12-3R406-20M	492
LMB-BOCZ38P-05	251	MP-086450-10	163	NM-60R710-05	498	NM-ARTO-12-3R711-20M	492
LMB-BOCZ38P-20M	251	MP-086450-80	163	NM-60R710-06	498	NM-BAHIA40-150-01	468
LMB-KAT38-05	252	MP-086500-10	163	NM-60R820-05	498	NM-BD-001-M1B	472
LMB-KAT38-20M	252	MP-086500-80	163	NM-A60710-01	485	NM-BD-003-01	464
LMB-SZCZ38-05	253	MP-086550-10	163	NM-A60710-02	485	NM-BD-003-02	464
LMB-SZCZ38-20M	253	MP-118350-10	163	NM-A60710-05	485	NM-BD-100-01	465
LO-00-00-001	251	MP-118400-10	163	NM-A60710-06	485	NM-BD-100-02	465
LO-00-00-003	251	MP-118450-10	163	NM-A60710-10N	485	NM-BD-100-05	465
LO-M2M-00-125-A	245	MP-118500-10	163	NM-A60710-20	485	NM-BD-100-06	465
LZ-AKZ312-10N	619	MP-150270-10	163	NM-A60710-80N	485	NM-BD-150-01	464
LZ-AKZ612-10N	620	MP-150300-10	163	NM-A60820-01	485	NM-BD-150-02	464
LZ-KA2MM-10	618	MP-150350-10	163	NM-A60820-02	485	NM-BD-712-M1	472
LZ-KAPR2M-10	619	MP-150400-10	163	NM-A60820-05	485	NM-BD727-100	470
		MP-150450-10	163	NM-A60820-06	485	NM-BD-739-05	470
		MP-150500-10	163	NM-A60820-10N*	485	NM-BD-762-01	466
		MP-150550-10	163	NM-A60820-20	485	NM-BD-762-05	466
<b>M</b>		MR-R0050-001	256	NM-A60820-80N	485	NM-BD-780-M1	465
MA-MATA-1-10	220	MR-RDRO-0000	254	NM-A60870-01*	485	NM-BD-780-M2	465
MA-MATA-1-20	220	MR-RS025-001	256	NM-A60870-02*	485	NM-BD-780-M5	465
MA-MATA-1-60	220	MR-SPG-UNI-GAL	127	NM-A60870-05*	485	NM-BD867-100	466
MC-J01A-12-01	230	MR-SPG-UNI-OC	127	NM-A60870-06*	485	NM-BD868-100	467
MC-J01A-12-06	230	MR-TDL011-01	233	NM-A60870-10N*	485	NM-BD868-150	467
MC-J01A-16-01	230	MR-TH002-L01	263	NM-A60870-20*	485	NM-BD869-150	467
MC-J01A-16-06	230	MR-TH002-P01	263	NM-A60870-80N*	485	NM-DAK27-060	471
MC-J04A2-14-01	231	MR-TH004-001	261	NM-A61100-01	485	NM-DAK27-080	471
MC-J04A2-14-05	231	MR-TH005-001	260	NM-A61100-02	485	NM-DAK27-100	471
MC-J04A2-18-01	231	MR-TH009-001	262	NM-A61100-05	485	NM-DAK27-120	471
MC-J04A2-22-01	231	MR-TH016-001	260	NM-A61100-06	485	NM-DAK27-150	471
MC-J60A27-01	231	MR-TH018-KPL	261	NM-A61100-10N*	485	NM-DAP77-60	468
MC-J62-01 232		MR-TH018-L01	264	NM-A61100-20	485	NM-DAP77-100	468
MC-J63-05 228		MR-TH018-P01	264	NM-A80710-01	486	NM-DAP77-150	468
MC-J65-08-01	229	MR-TH019-001	265	NM-A80710-02	486	NM-DPA20-100	480
MC-J65-08-05	229	MR-TH019-003	265	NM-A80710-03	486	NM-DPA20-100W	480
MC-J65-10-01	229	MR-TH035-KPL	262	NM-A80710-05	486	NM-DPA20-150	480
MC-J65-10-05	229	MR-THA12-001	259	NM-A80710-06	486	NM-DPA20-150W	480
MC-J65-12-01	229	MR-THB12-001	259	NM-A80710-10	486	NM-DPD20-100	479
MC-J65-12-05	229	MR-THQ21-001	264	NM-A80710-20	486	NM-F50710-01	489
MC-J123-01	229	MR-WP-010-01	258	NM-A80710-80	486	NM-F50710-06	489
MC-J123-05	229	MR-WP-011-01	258	NM-A80870-01	486	NM-F50710-10	489
MC-K135-06-01	230	MR-WP-15-KPL	263	NM-A80870-02	486	NM-F50710-20	489
MG-MENSA-010	250	MR-WP-028-01	254	NM-A80870-03	486	NM-F50870-01	489
MG-MENSA-030	250	MR-WP2802-01	266	NM-A80870-05	486	NM-F50870-06	489
MM-FI20X6X7-PL10-A-1T	246	MR-WP2804-01	267	NM-A80870-06	486	NM-F50870-10	489
MM-FI20X6X7-PL20-A-1T	246						
MM-FI20X6X7-PL30-A-1T	246						

NM-F50870-20	489	NM-S60710-06A	488	OM-OBO400-05	336	PA-GLAXNBDW3M16-AL	583
NM-G60710-01N	487	NM-S60710-10A	488			PA-GLAXNBDW3M19-AL	583
NM-G60710-02N	487	NM-S60710-20A	488	<b>P</b>		PA-GLAXNBDW3M-AL	583
NM-G60710-05N	487	NM-S60820-01A	488	PA-0242-35-50	404	PA-GLAXNB3M16-AL	580
NM-G60710-06N	487	NM-S60820-02A	488	PA-0242-35-50-06	404	PA-GLAXNB3M19-AL	580
NM-G60710-10N	487	NM-S60820-05A	488	PA-0242-35-50-20M	404	PA-GLAXNB3M-AL	580
NM-G60710-20N	487	NM-S60820-06A	488	PA-0243-35-50	405	PA-GLAXNB3M16-AL	581
NM-G60710-80N	487	NM-S60820-10A	488	PA-0243-35-50-06	405	PA-GLAXNB3M19-AL	581
NM-G60820-01N	487	NM-S60820-20A	488	PA-0243-35-50-20M	405	PA-GLAXNB3M-AL	581
NM-G60820-05N	487	NM-SQ40ADJ-060	469	PA-CPGLAXAH-00	556, 558,	PA-GLAXNK3M-AL	567
NM-G60820-06N	487	NM-SQ40ADJ-100	469		560, 562, 564	PA-GLAXNK-AL	567
NM-G60820-100*N	487	NM-SQA100-01	469	PA-CPGLAXAV-00	556, 558,	PA-GLAXNKKT3M-AL	575
NM-G60820-20N	487	NM-SQA150-01	469		560, 562, 564	PA-GLAXNKKT3M-AL-10	575
NM-G61100-01N	487	NM-STGY135-100-01	473	PA-CPGLAXL-00	556, 558,	PA-GLAXNKKT3M-AL-20M	575
NM-G61100-20N	487	NM-STGY135-130-01	473		560, 562, 564	PA-GLAXNKKT-AL	575
NM-INDUSTRIA-H20-710X-820-20M	494	NM-STGY135-150-01	473	PA-GLAX3M-AL	570	PA-GLAXNKKT-AL-10	575
NM-INDUSTRIA-H40-710X-820-20M	494	NM-STOMP-100-01	473	PA-GLAX3M-AL-10	570	PA-GLAXNKKT-AL-20M	575
NM-INDUSTRIA-P20-710X-820-20M	495	NM-STOMP-120-10	473	PA-GLAX3M-AL-20M	570	PA-GLAXNKKT-AL-90	575
NM-INDUSTRIA-P40-710X-820-20M	495	NM-STOMP-120-20	473	PA-GLAX-AL	570	PA-GLAXRAD-AL	573
NM-INDUSTRIA-P80-710X-820-20M	495	NM-STOMP-130-01	473	PA-GLAX-AL-10	570	PA-GLAXREG1-AL	579
NM-INDUSTRIA-T20-710X-820-20M	496	NM-STOMP-130-06	473	PA-GLAX-AL-20M	570	PA-GLAXREG2-AL	579
NM-INDUSTRIA-T40-710X-820-20M	496	NM-STOMP-150-01	473	PA-GLAX-AL-90	570	PA-GLAXWN3M-AL	574
NM-INDUSTRIA-T40-710X-820-20M	496	NM-STOMP-160-01	473	PA-GLAXDR-AL	572	PA-GLAXWN3M-AL-06	574
NM-INDUSTRIA-T40-710X-820-20M	496	NM-STOMP-160-06	473	PA-GLAXGK3M-00C	556	PA-GLAXWN3M-AL-10	574
NM-INDUSTRIA-T40-710X-820-20M	496	NM-STOPKA-M6	478	PA-GLAXGKS3M-00C	558	PA-GLAXWN3M-AL-20M	574
NM-INDUSTRIA-T40-710X-820-20M	496	NM-STOPKSZESTK-M6	478	PA-GLAXGKW3M-00C	560	PA-GLAXWN16-AL	574
NM-INDUSTRIA-X20-710X-820-20M	497	NM-WPJ22-D20	476	PA-GLAXGKW3M-00C	562	PA-GLAXWN19-AL	574
NM-INDUSTRIA-X40-710X-820-20M	497	NM-X-LINE40710-01	490	PA-GLAXGKZ3M-00C	564	PA-GLAXWN-AL	574
NM-INDUSTRIA-X80-710X-820-20M	497	NM-X-LINE40710-10	490	PA-GLAXKT3M-AL	584	PA-GLAXWPKT-AL	585
		NM-X-LINE40710-20	490	PA-GLAXKT-AL	584	PA-LACZVELLO-CIN-05	414
				PA-GLAXMIC3M-AL	569	PA-LACZVELLO-CIN-06	414
				PA-GLAXMICNK3M-AL	565	PA-LACZVELLO-CIN-10M	414
				PA-GLAXMICNK-AL	565	PA-LACZVELLO-CIN-20M	414
				PA-GLAXMNB3M19-AL	577	PA-LACZVELLO-CIN-21	414
				PA-GLAXMNB3M-AL	577	PA-LACZVELLO-COUT-05	414
				PA-GLAXMNB3M19-AL	576	PA-LACZVELLO-COUT-06	414
				PA-GLAXMNB3M-AL	576	PA-LACZVELLO-COUT-10M	414
				PA-GLAXMNB3M-AL	576	PA-LACZVELLO-COUT-20M	414
				PA-GLAXMNB3M-AL	576	PA-LACZVELLO-COUT-21	414
				PA-GLAXMNB3M-AL	576	PA-LACZVELLO-LIN-05	415
				PA-GLAXMNB3M-AL	576	PA-LACZVELLO-LIN-06	415
				PA-GLAXMNB3M-AL	576	PA-LACZVELLO-LIN-10M	415
				PA-GLAXMNB3M-AL	576	PA-LACZVELLO-LIN-20M	415
				PA-GLAXMNB3M-AL	576	PA-LACZVELLO-LIN-21	415
				PA-GLAXMNB3M-AL	576	PA-LACZVELLO-LOUT-05	415
				PA-GLAXMNB3M-AL	576	PA-LACZVELLO-LOUT-06	415
				PA-GLAXMNB3M-AL	576	PA-LACZVELLO-LOUT-10M	415
				PA-GLAXMNB3M-AL	576	PA-LACZVELLO-LOUT-20M	415
				PA-GLAXMNB3M-AL	576	PA-LACZVELLO-LOUT-21	415
				PA-GLAXMNB3M-AL	576	PA-OSCLGLAX-00	570, 574, 575
				PA-GLAXMNB3M-AL	571	PA-OSCLGLAX3M-00	
				PA-GLAXMNB3M-AL	571		570, 574, 575
				PA-GLAXMNB3M-AL	571	PA-OSCLGLAXM-00	566
				PA-GLAXMNB3M-AL	571	PA-OSCLGLAXM3M-00	
				PA-GLAXMNB3M-AL	571		556, 558, 560,
				PA-GLAXMNB3M-AL	571		562, 564, 566

PA-OSMLGLAX-00	567, 570, 572, 573, 574, 575, 579, 584, 585	PA-VELLO-L4M-10	406	PA-ZASVELLO-LNP-10	406	PB-3D0SHX18-450-H	129
		PA-VELLO-L4M-20	406	PA-ZASVELLO-LNP-20M	406	PB-3D0SHX18-450-PRO	128
		PA-VELLO-L4M-21	406	PA-ZASVELLO-LNP-21	406	PB-3D0SHX18-500-H	129
PA-OSMLGLAX3M-00	567, 570, 574, 575, 580, 581, 582, 583, 584	PA-VELLO-TD3M-05	412	PA-ZASVELLO-LPL-05	406	PB-3D0SHX18-500-PRO	128
		PA-VELLO-TD3M-06	412	PA-ZASVELLO-LPL-06	406	PB-3D0SHX18-550-H	129
		PA-VELLO-TD3M-10	412	PA-ZASVELLO-LPL-10	406	PB-3D0SHX18-550-PRO	128
PA-OSMLGLAXM-00	566, 568, 571, 578	PA-VELLO-TD3M-20M	412	PA-ZASVELLO-LPP-20M	406	PB-3D0SHX18-600-H	129
		PA-VELLO-TD3M-21	412	PA-ZASVELLO-LPL-21	406	PB-45-002X15-60A	298
PA-OSMLGLAXM3M-00	556, 558, 560, 562, 564, 566, 576, 577	PA-VELLO-TJ3M-05	410	PA-ZASVELLO-LPP-05	406	PB-45-002X20-60A	296
		PA-VELLO-TJ3M-06	410	PA-ZASVELLO-LPP-06	406	PB-45-0010X3-60A	295
		PA-VELLO-TJ3M-10	410	PA-ZASVELLO-LPP-10	406	PB-45-202X10-60A	296, 300
PA-OSMLGLAXMIC-00N	565, 569	PA-VELLO-TJ3M-20M	410	PA-ZASVELLO-LPP-20M	406	PB-45-400MF-2X16-60A	294
		PA-VELLO-TJ3M-21	410	PA-ZASVELLO-LPP-21	406	PB-45-450-2X20-60A	300
PA-OSMLGLAXMIC3M-00N	565, 569	PA-ZASGLAX-00	570	PA-ZASVELO-CP-10	408	PB-45-450MF202X10-60A	301
		PA-ZASGLAX-10	570	PA-ZASVELO-CP-20M	408	PB-45-600MF-2X27-60A	303
PA-OSMLGLAXMK-00	566, 571	PA-ZASGLAX-20M	570	PA-ZAWGLAXDR-00	572, 573	PB-45-002010-60A	295
PA-OSMLGLAXMK3M-00	556, 558, 560, 562, 564	PA-ZASGLAX-90	570	PA-ZGLAXKTOMZ-00	587	PB-45-MF2X15-60A	299
		PA-ZASGLAXDR-00	572	PA-ZGLAXMNMKOMZ-00	586	PB-45-MF002X20-60A	297, 301
PA-OSMLGLAXMO-00	566	PA-ZASGLAXKT-00	584	PA-ZGLAXMNMKOMZ-10	586	PB-45-MF2X34-60A	302
PA-OSMLGLAXMO3M-00	556, 558, 560, 562, 564	PA-ZASGLAXMIC-00	569	PA-ZGLAXMNMKOMZ-20M	586	PB-45-MF202X10-60A	297
		PA-ZASGLAXMICNK-00	565	PA-ZGLAXNKKTOMZ-10	587	PB-45-MF342X17-60A	302
PA-OSMLGLAXSO-00	573	PA-ZASGLAXMNK-00	566	PA-ZGLAXNKKTOMZ-20M	587	PB-91024160V	305
PA-OSMLGLAXT-00	575	PA-ZASGLAXMNK-20M	566	PA-ZGLAXOMZ-00	586	PB-93004162601	305
PA-OSMLGLAXT3M-00	556, 558, 560, 562, 564	PA-ZASGLAXMNK-90	566	PA-ZGLAXOMZ-10	586	PB-AS-600-1X15L-2X7L	304
		PA-ZASGLAXMNKK-00	566	PA-ZGLAXOMZ-20M	586	PB-AS-600-1X15L-3X7L	304
PA-OSTRGLAX-00	567, 570, 572, 573, 574, 575, 579, 584, 585	PA-ZASGLAXMNKO-00	566	PB-0FPO18-250	134	PB-AS-600-2X15L	304
		PA-ZASGLAXMNKW-00	568	PB-0FPO18-300	134	PB-AS-600-2X15L-2X7L	304
		PA-ZASGLAXMNKW-10	568	PB-0FPO18-350	134	PB-AS-700-2X15L-2X7L	304
PA-OSTRGLAX3M-00	567, 570, 574, 575, 580, 581, 582, 583, 584	PA-ZASGLAXMNKW-20M	568	PB-0FPO18-400	134	PB-AS-800-2X15L-2X7L	304
		PA-ZASGLAXMNKW-90	568	PB-0FPO18-450	134	PB-AS-800-4X15L	304
		PA-ZASGLAXMW-00	571	PB-0FPO18-500	134	PB-AS-900-4X15L	304
PA-OSTRGLAXM-00	566, 568, 571, 578	PA-ZASGLAXMW-10	571	PB-0FPO18-550	134	PB-AXISPRO-KPL69-450-10169	
		PA-ZASGLAXMW-20M	571	PB-0FPO18-600	134	PB-AXISPRO-KPL69-450-60169	
PA-OSTRGLAXM3M-00	566, 576, 577	PA-ZASGLAXMW-90	571	PB-0SHX-250-A	130	PB-AXISPRO-KPL69-500-10169	
		PA-ZASGLAXMWK-00	571	PB-0SHX-270-A	130	PB-AXISPRO-KPL69-500-60169	
PA-ROZGLAX-53	572	PA-ZASGLAXNK-00	567	PB-0SHX-300-A	130	PB-AXISPRO-KPL250A	167
PA-ROZGLAXP-53	572	PA-ZASGLAXNKKT-00	575	PB-0SHX-350-A	130	PB-AXISPRO-KPL250A1	167
PA-SPRGLAXM-00	566, 568, 573	PA-ZASGLAXNKKT-10	575	PB-0SHX-400-A	130	PB-AXISPRO-KPL250B	167
		PA-ZASGLAXNKKT-20M	575	PB-0SHX-450-A	130	PB-AXISPRO-KPL250B1	167
PA-SPRGLAXMIC-00	565, 575	PA-ZASGLAXNKKT-90	575	PB-0SHX-500-A	130	PB-AXISPRO-KPL250C	168
PA-USZGLAX-00N	574	PA-ZASGLAXNKKT-00	575	PB-0SHX-550-A	130	PB-AXISPRO-KPL250C1	168
PA-USZGLAX-10N	574	PA-ZASGLAXRAD-00	573	PB-0SHX-600-A	130	PB-AXISPRO-KPL250D	168
PA-VELLO-C3M-05	408	PA-ZASVELLO-CN-05	408	PB-3D0FPO18-250-PRO	132	PB-AXISPRO-KPL250D1	168
PA-VELLO-C3M-06	408	PA-ZASVELLO-CN-06	408	PB-3D0FPO18-300-PRO	132	PB-AXISPRO-KPL300A	167
PA-VELLO-C3M-10	408	PA-ZASVELLO-CN-10	408	PB-3D0FPO18-350-PRO	132	PB-AXISPRO-KPL300A1	167
PA-VELLO-C3M-20M	408	PA-ZASVELLO-CN-20M	408	PB-3D0FPO18-400-PRO	132	PB-AXISPRO-KPL300B	167
PA-VELLO-C4M-05	408	PA-ZASVELLO-CN-21	408	PB-3D0FPO18-450-PRO	132	PB-AXISPRO-KPL300B1	167
PA-VELLO-C4M-06	408	PA-ZASVELLO-CP-05	408	PB-3D0FPO18-500-PRO	132	PB-AXISPRO-KPL300C	168
PA-VELLO-C4M-10	408	PA-ZASVELLO-CP-06	408	PB-3D0FPO18-550-PRO	132	PB-AXISPRO-KPL300C1	168
PA-VELLO-C4M-20M	408	PA-ZASVELLO-CP-21	408	PB-3D0FPO18-600-PRO	132	PB-AXISPRO-KPL300D	168
PA-VELLO-C4M-21	408	PA-ZASVELLO-LNL-05	406	PB-3D0SHX18-250-H	129	PB-AXISPRO-KPL300D1	168
PA-VELLO-L3M-05	406	PA-ZASVELLO-LNL-06	406	PB-3D0SHX18-300-H	129	PB-AXISPRO-KPL350A	167
PA-VELLO-L3M-06	406	PA-ZASVELLO-LNL-10	406	PB-3D0SHX18-300-PRO	128	PB-AXISPRO-KPL350A1	167
PA-VELLO-L3M-10	406	PA-ZASVELLO-LNL-20M	406	PB-3D0SHX18-350-H	129	PB-AXISPRO-KPL350B	167
PA-VELLO-L3M-20M	406	PA-ZASVELLO-LNL-21	406	PB-3D0SHX18-350-PRO	128	PB-AXISPRO-KPL350B1	167
PA-VELLO-L4M-05	406	PA-ZASVELLO-LNP-05	406	PB-3D0SHX18-400-H	129	PB-AXISPRO-KPL350C	168
PA-VELLO-L4M-06	406	PA-ZASVELLO-LNP-06	406	PB-3D0SHX18-400-PRO	128	PB-AXISPRO-KPL350C1	168

PB-AXISPRO-KPL350D	168	PB-AXISPRO-P20-KPL300D1171	PB-AXISPRO-RELKW500	175	PB-D-CONREL	207
PB-AXISPRO-KPL350D1	168	PB-AXISPRO-P20-KPL350A 169	PB-AXISPRO-RELKW500-10	175	PB-D-CONREL-10	207
PB-AXISPRO-KPL400A	167	PB-AXISPRO-P20-KPL350A1169	PB-AXISPRO-RELKW550	175	PB-D-CONREL-KW	192
PB-AXISPRO-KPL400A1	167	PB-AXISPRO-P20-KPL350B 170	PB-AXISPRO-RELKW550-10	175	PB-D-CONREL-KW-10	192
PB-AXISPRO-KPL400B	167	PB-AXISPRO-P20-KPL350B1170	PB-AXISPRO-SYNCHRO-P20		PB-D-D2R0-00	193, 211
PB-AXISPRO-KPL400B1	167	PB-AXISPRO-P20-KPL350C 170		169, 170, 171	PB-D-D2R0-01	193, 211
PB-AXISPRO-KPL400C	168	PB-AXISPRO-P20-KPL350C1170	PB-AXISPRO-SYNCHRO-P20-		PB-D-KPL68-450-10	213
PB-AXISPRO-KPL400C1	168	PB-AXISPRO-P20-KPL350D 171	-MOC 169, 170, 171		PB-D-KPL68-450-80	213
PB-AXISPRO-KPL400D	168	PB-AXISPRO-P20-KPL350D1171	PB-AXISPRO-WEWMOCA	171	PB-D-KPL68-500-10	213
PB-AXISPRO-KPL400D1	168	PB-AXISPRO-P20-KPL400A 169	PB-AXISPRO-WEWMOCA1	171	PB-D-KPL68-500-80	213
PB-AXISPRO-KPL450A	167	PB-AXISPRO-P20-KPL400A1169	PB-AXISPRO-WEWMOCB	172	PB-D-KPL250A	199
PB-AXISPRO-KPL450A1	167	PB-AXISPRO-P20-KPL400B 170	PB-AXISPRO-WEWMOCB1	172	PB-D-KPL250A1	199
PB-AXISPRO-KPL450B	167	PB-AXISPRO-P20-KPL400B1170	PB-AXISPRO-WEWMOCB	172	PB-D-KPL250B	200
PB-AXISPRO-KPL450B1	167	PB-AXISPRO-P20-KPL400C 170	PB-AXISPRO-WEWMOCB1	172	PB-D-KPL250B1	200
PB-AXISPRO-KPL450C	168	PB-AXISPRO-P20-KPL400C1170	PB-AXISPRO-WEWMOC	173	PB-D-KPL250C	200
PB-AXISPRO-KPL450C1	168	PB-AXISPRO-P20-KPL400D 171	PB-AXISPRO-WEWMOCB1	173	PB-D-KPL250C1	200
PB-AXISPRO-KPL450D	168	PB-AXISPRO-P20-KPL400D1171	PB-AXISPRO-ZESWEW-A		PB-D-KPL300A	199
PB-AXISPRO-KPL450D1	168	PB-AXISPRO-P20-KPL450A 169	AXISPRO	173	PB-D-KPL300A1	199
PB-AXISPRO-KPL500A	167	PB-AXISPRO-P20-KPL450A1169	PB-AXISPRO-ZESWEW-A		PB-D-KPL300B	200
PB-AXISPRO-KPL500A1	167	PB-AXISPRO-P20-KPL450B 170	AXISPRO	173	PB-D-KPL300B1	200
PB-AXISPRO-KPL500B	167	PB-AXISPRO-P20-KPL450B1170	PB-AXISPRO-ZESWEW-B1		PB-D-KPL300C	200
PB-AXISPRO-KPL500B1	167	PB-AXISPRO-P20-KPL450C 170	AXISPRO	174	PB-D-KPL300C1	200
PB-AXISPRO-KPL500C	168	PB-AXISPRO-P20-KPL450C1170	PB-AXISPRO-ZESWEW-B		PB-D-KPL350A	199
PB-AXISPRO-KPL500C1	168	PB-AXISPRO-P20-KPL450D 171	AXISPRO	174	PB-D-KPL350A1	199
PB-AXISPRO-KPL500D	168	PB-AXISPRO-P20-KPL450D1171	PB-AXISPRO-ZESWEW-C1		PB-D-KPL350B	200
PB-AXISPRO-KPL500D1	168	PB-AXISPRO-P20-KPL500A 169	AXISPRO	174	PB-D-KPL350B1	200
PB-AXISPRO-KPL550A	167	PB-AXISPRO-P20-KPL500A1169	PB-AXISPRO-ZESWEW-C		PB-D-KPL350C	200
PB-AXISPRO-KPL550A1	167	PB-AXISPRO-P20-KPL500B 170	AXISPRO	174	PB-D-KPL350C1	200
PB-AXISPRO-KPL550B	167	PB-AXISPRO-P20-KPL500B1170	PB-AXISPRO-ZESWEW-D1		PB-D-KPL400A	199
PB-AXISPRO-KPL550B1	167	PB-AXISPRO-P20-KPL500C 170	AXISPRO	175	PB-D-KPL400A1	199
PB-AXISPRO-KPL550C	168	PB-AXISPRO-P20-KPL500C1170	PB-AXISPRO-ZESWEW-D		PB-D-KPL400B	200
PB-AXISPRO-KPL550C1	168	PB-AXISPRO-P20-KPL500D 171	AXISPRO	175	PB-D-KPL400B1	200
PB-AXISPRO-KPL550D	168	PB-AXISPRO-P20-KPL500D1171	PB-AXISPRO-ZNACZ-FRONT175		PB-D-KPL400C	200
PB-AXISPRO-KPL550D1	168	PB-AXISPRO-P20-KPL550A 169	PB-D-BXSIDE45B	208	PB-D-KPL400C1	200
PB-AXISPRO-KPL600A	167	PB-AXISPRO-P20-KPL550A1169	PB-D-BXSIDE45B-10	208	PB-D-KPL450A	199
PB-AXISPRO-KPL600A1	167	PB-AXISPRO-P20-KPL550B 170	PB-D-BXSIDE45C	209	PB-D-KPL450A1	199
PB-AXISPRO-KPL600B	167	PB-AXISPRO-P20-KPL550B1170	PB-D-BXSIDE45C-10	209	PB-D-KPL450B	200
PB-AXISPRO-KPL600B1	167	PB-AXISPRO-P20-KPL550C 170	PB-D-BXSIDE50B	208	PB-D-KPL450B1	200
PB-AXISPRO-KPL600C	168	PB-AXISPRO-P20-KPL550C1170	PB-D-BXSIDE50B-10	208	PB-D-KPL450C	200
PB-AXISPRO-KPL600C1	168	PB-AXISPRO-P20-KPL550D 171	PB-D-BXSIDE50C	209	PB-D-KPL450C1	200
PB-AXISPRO-KPL600D	168	PB-AXISPRO-P20-KPL550D1171	PB-D-BXSIDE50C-10	209	PB-D-KPL500A	199
PB-AXISPRO-KPL600D1	168	PB-AXISPRO-P20-KPL600A 169	PB-D-BXSIDEKW25C	194	PB-D-KPL500A1	199
PB-AXISPRO-P20-KPL250A 169		PB-AXISPRO-P20-KPL600A1169	PB-D-BXSIDEKW25C-10	194	PB-D-KPL500B	200
PB-AXISPRO-P20-KPL250A1169		PB-AXISPRO-P20-KPL600B 170	PB-D-BXSIDEKW30C	194	PB-D-KPL500B1	200
PB-AXISPRO-P20-KPL250B 170		PB-AXISPRO-P20-KPL600B1170	PB-D-BXSIDEKW30C-10	194	PB-D-KPL500C	200
PB-AXISPRO-P20-KPL250B1170		PB-AXISPRO-P20-KPL600C 170	PB-D-BXSIDEKW35C	194	PB-D-KPL500C1	200
PB-AXISPRO-P20-KPL250C 170		PB-AXISPRO-P20-KPL600C1170	PB-D-BXSIDEKW35C-10	194	PB-D-KPL550A	199
PB-AXISPRO-P20-KPL250C1170		PB-AXISPRO-P20-KPL600D 171	PB-D-BXSIDEKW40C	194	PB-D-KPL550A1	199
PB-AXISPRO-P20-KPL250D 171		PB-AXISPRO-P20-KPL600D1171	PB-D-BXSIDEKW40C-10	194	PB-D-KPL550B	200
PB-AXISPRO-P20-KPL250D1171		PB-AXISPRO-RELKW300	PB-D-BXSIDEKW45C	194	PB-D-KPL550B1	200
PB-AXISPRO-P20-KPL300A 169		PB-AXISPRO-RELKW300-10 175	PB-D-BXSIDEKW45C-10	194	PB-D-KPL550C	200
PB-AXISPRO-P20-KPL300A1169		PB-AXISPRO-RELKW350	PB-D-BXSIDEKW50C	194	PB-D-KPL550C1	200
PB-AXISPRO-P20-KPL300B 170		PB-AXISPRO-RELKW350-10 175	PB-D-BXSIDEKW50C-10	194	PB-D-LR-00-0	206
PB-AXISPRO-P20-KPL300B1170		PB-AXISPRO-RELKW400	PB-D-BXSIDEKW55C	194	PB-D-LR-00-10	206
PB-AXISPRO-P20-KPL300C 170		PB-AXISPRO-RELKW400-10 175	PB-D-BXSIDEKW55C-10	194	PB-D-MATRYCA	197, 211
PB-AXISPRO-P20-KPL300C1170		PB-AXISPRO-RELKW450	PB-D-CONBXSID	207	PB-D-MBSTAB-00	213
PB-AXISPRO-P20-KPL300D 171		PB-AXISPRO-RELKW450-10 175	PB-D-CONBXSIDE-10	207	PB-D-MHG04	212



PB-D-MHG04-KW	196	PB-D-WEWMOCC	203	PB-KW-KPL350C	188	PB-MBPRO-KPL500A1	177, 178
PB-D-N2R0-00	195, 209	PB-D-WEWMOCC1	203	PB-KW-KPL350C1	188	PB-MBPRO-KPL500B	177
PB-D-N2R0-01	195, 209	PB-D-WEWMOCC-KW	190	PB-KW-KPL400A	187	PB-MBPRO-KPL500B1	177
PB-D-P20250A	199	PB-D-WEWMOCC-KW-10	190	PB-KW-KPL400A1	187	PB-MBPRO-KPL500C	178
PB-D-P20300A	199	PB-D-WEWORG-A	204	PB-KW-KPL400B	187	PB-MBPRO-KPL500C1	178
PB-D-P20300C	200	PB-D-WEWORG-A-10	204	PB-KW-KPL400B1	187	PB-MBPRO-KPL550A	177, 178
PB-D-P20350A	199	PB-D-WEWORG-B	204	PB-KW-KPL400C	188	PB-MBPRO-KPL550A1	177, 178
PB-D-P20350C	200	PB-D-WEWORG-B-10	204	PB-KW-KPL400C1	188	PB-MBPRO-KPL550B	177
PB-D-P20400A	199	PB-D-WEWORGKW-A	191	PB-KW-KPL450A	187	PB-MBPRO-KPL550B1	177
PB-D-P20400C	200	PB-D-WEWORGKW-A-10	191	PB-KW-KPL450A1	187	PB-MBPRO-KPL550C	178
PB-D-P20450A	199	PB-D-WEWORGKW-B	192	PB-KW-KPL450B	187	PB-MBPRO-KPL550C1	178
PB-D-P20450C	200	PB-D-WEWORGKW-B-10	192	PB-KW-KPL450B1	187	PB-MBPRO-MOCRELYTL	183
PB-D-P20500A	199	PB-D-WEWSZKLC	202	PB-KW-KPL450C	188	PB-MBPRO-MOCRELYTL1	183
PB-D-P20500C	200	PB-D-WEWSZKLC-10	202	PB-KW-KPL450C1	188	PB-MBPRO-RELKW300178,	179
PB-D-P20550C	200	PB-D-ZESWEW-C	203	PB-KW-KPL500A	187	PB-MBPRO-RELKW300-10	178,
PB-D-P20STAB	165	PB-D-ZESWEW-C-10	203	PB-KW-KPL500A1	187	179	
PB-D-PRZEGLP	208	PB-D-ZESWEWKW-C	190	PB-KW-KPL500B	187	PB-MBPRO-RELKW350178,	179
PB-D-PRZEGLP-10	208	PB-D-ZESWEWKW-C-10	190	PB-KW-KPL500B1	187	PB-MBPRO-RELKW350-10	178,
PB-D-PRZEGLP-KW	193	PB-D-ZLE-450	214	PB-KW-KPL500C	188	179	
PB-D-PRZEGLP-KW-10	193	PB-D-ZLE-500	214	PB-KW-KPL500C1	188	PB-MBPRO-RELKW400178,	179
PB-D-REL450-10	201	PB-D-ZNACZ-0	197, 212	PB-KW-KPL550A	187	PB-MBPRO-RELKW400-10	178,
PB-D-REL500-10	201	PB-D-ZR-00-0	205	PB-KW-KPL550A1	187	179	
PB-D-REL550-10	201	PB-D-ZR-00-10	205	PB-KW-KPL550B	187	PB-MBPRO-RELKW450178,	179
PB-D-REL2500	201	PB-D-ZR-KW-00	191	PB-KW-KPL550B1	187	PB-MBPRO-RELKW450-10	178,
PB-D-REL3000	201	PB-D-ZR-KW-10	191	PB-KW-KPL550C	188	179	
PB-D-REL3500	201	PB-G10HX300-H	135	PB-KW-KPL550C1	188	PB-MBPRO-RELKW500178,	179
PB-D-REL4000	201	PB-G10HX-350	135	PB-KW-KPL600A	187	PB-MBPRO-RELKW500-10	178,
PB-D-REL4500	201	PB-G10HX-450	135	PB-KW-KPL600A1	187	179	
PB-D-REL5000	201	PB-G10HX-500	135	PB-KW-KPL600B	187	PB-MBPRO-RELKW550178,	179
PB-D-REL5500	201	PB-G10HX-550	135	PB-KW-KPL600B1	187	PB-MBPRO-RELKW550-10	178,
PB-D-RELCOV	206	PB-GCHX18-300-H	131	PB-KW-KPL600C	188	179	
PB-D-RELCOV-10	206	PB-GCHX18-350-H	131	PB-KW-KPL600C1	188	PB-MBPRO-WEWMOCA	179
PB-D-RELKW350	188	PB-GCHX18-400-H	131	PB-MBPRO-KPL300A	177, 178	PB-MBPRO-WEWMOCA1	179
PB-D-RELKW350-10	188	PB-GCHX18-450-H	131	PB-MBPRO-KPL300A1	177, 178	PB-MBPRO-WEWMOCB	180
PB-D-RELKW400	188	PB-GCHX18-500-H	131	PB-MBPRO-KPL300B	177	PB-MBPRO-WEWMOCB1	180
PB-D-RELKW400-10	188	PB-GCHX18-550-H	131	PB-MBPRO-KPL300B1	177	PB-MBPRO-WEWMOCC	180
PB-D-RELKW450	188	PB-KO450B0	313	PB-MBPRO-KPL300C	178	PB-MBPRO-WEWMOCC1	180
PB-D-RELKW450-10	188	PB-KO450B0-E-L	314	PB-MBPRO-KPL300C1	178	PB-MBPRO-WEWMOCCD	181
PB-D-RELKW500	188	PB-KO450B0-E-R	314	PB-MBPRO-KPL350A	177, 178	PB-MBPRO-WEWMOCCD1	181
PB-D-RELKW500-10	188	PB-KO450B0-L1	312	PB-MBPRO-KPL350A1	177, 178	PB-MBPRO-ZESWEW-A	184
PB-D-RELKW550	188	PB-KO450B0-R1	312	PB-MBPRO-KPL350B	177	PB-MBPRO-ZESWEW-A1	184
PB-D-RELKW550-10	188	PB-KW-KPL250A	187	PB-MBPRO-KPL350B1	177	PB-MBPRO-ZESWEW-B	184
PB-D-S2R0-00	195, 210	PB-KW-KPL250A1	187	PB-MBPRO-KPL350C	178	PB-MBPRO-ZESWEW-B1	184
PB-D-S2R0-01	195, 210	PB-KW-KPL250B	187	PB-MBPRO-KPL350C1	178	PB-MBPRO-ZESWEW-C	185
PB-D-UCHWEW	205	PB-KW-KPL250B1	187	PB-MBPRO-KPL400A	177, 178	PB-MBPRO-ZESWEW-C1	185
PB-D-UCHWEW-10	205	PB-KW-KPL250C	188	PB-MBPRO-KPL400A1	177, 178	PB-MBPRO-ZESWEW-D	185
PB-D-ULE-500	214	PB-KW-KPL250C1	188	PB-MBPRO-KPL400B	177	PB-MBPRO-ZESWEW-D1	185
PB-D-W2R0-00	196, 210	PB-KW-KPL300A	187	PB-MBPRO-KPL400B1	177	PB-MBPRO-ZLATYLA	181
PB-D-W2R0-01	196, 210	PB-KW-KPL300A1	187	PB-MBPRO-KPL400C	178	PB-MBPRO-ZLATYLA1	181
PB-D-WEWMOCA	201	PB-KW-KPL300B	187	PB-MBPRO-KPL400C1	178	PB-MBPRO-ZLATYLB	182
PB-D-WEWMOCA1	201	PB-KW-KPL300B1	187	PB-MBPRO-KPL450A	177, 178	PB-MBPRO-ZLATYLB1	182
PB-D-WEWMOCA-KW	189	PB-KW-KPL300C	188	PB-MBPRO-KPL450A1	177, 178	PB-MBPRO-ZLATYLC	182
PB-D-WEWMOCA-KW-10	189	PB-KW-KPL300C1	188	PB-MBPRO-KPL450B	177	PB-MBPRO-ZLATYLC1	182
PB-D-WEWMOCB	202	PB-KW-KPL350A	187	PB-MBPRO-KPL450B1	177	PB-MBPRO-ZLATYLD	178, 183
PB-D-WEWMOCB1	202	PB-KW-KPL350A1	187	PB-MBPRO-KPL450C	178	PB-MBPRO-ZLATYLD1	178, 183
PB-D-WEWMOCB-KW	189	PB-KW-KPL350B	187	PB-MBPRO-KPL450C1	178	PB-SYNCHROP20-PRO	132
PB-D-WEWMOCB-KW-10	189	PB-KW-KPL350B1	187	PB-MBPRO-KPL500A	177, 178	PB-SYNCHROP20-PRO-MOC132	



PB-SZABLON-AXIS-MB	215	PD-LIFT-P20-STRONG-		PK-0-H35-3000L	154	PK-0H45450HK	150
PB-SZABLON-AXIS-MBPRO216		-PLUS-80	114	PK-0-H35-3500	153	PK-0H45500GX1	149
PB-WSPCOK	133	PD-MDLIFT-P1-D	124	PK-0H35-3500	152	PK-0H45500GX2-A	151
PD-ECGDL-060	126	PD-MDLIFT-P2-D	125	PK-0-H35-3500L	154	PK-0H45500HK	150
PD-ECGDL-080	126	PD-MD-ZB-01-KPL	107	PK-0-H35-4000	153	PK-0H45500GX1	149
PD-ECGDL-150	126	PD-MD-ZB-04-KPL	107	PK-0H35-4000	152	PK-0H45550GX2-A	151
PD-G0050-N02	118	PD-MINILIFTNEW-LIGHT	115	PK-0-H35-4000L	154	PK-0H45550HK	150
PD-G0050-N03	119	PD-MINILIFTNEW-LIGHT-20115		PK-0-H35-4500	153	PK-0H45600GX1	149
PD-G0060-N02	118	PD-MINILIFTNEW-MEDIUM	115	PK-0H35-4500	152	PK-0H45600GX2-A	151
PD-G0060-N03	119	PD-MINILIFTNEW-MEDIUM-20		PK-0-H35-4500L	154	PK-0H45600HK	150
PD-G0080-N02	118	115		PK-0-H35-5000	153	PK-0H45650GX1	149
PD-G0080-N03	119	PD-MINILIFTNEW-STRONG	115	PK-0H35-5000	152	PK-0H45650GX2-A	151
PD-G0100-N02	118	PD-MINILIFTNEW-STRONG-20		PK-0-H35-5000L	154	PK-0H45650HK	150
PD-G0100-N03	119	115		PK-0-H45-250	145	PK-0H45700GX1	149
PD-G0120-N02	118	PD-PD000-001	122	PK-0-H45-300	145	PK-0H45700GX2-A	151
PD-G0120-N03	119	PD-PD000-001B	123	PK-0-H45-350	145	PK-0H45700HK	150
PD-G0150-N02	118	PG-AL4560-20	292	PK-0-H45-400	145	PK-0H45750HK	150
PD-G0150-N03	119	PG-AL6083-20	292	PK-0-H45-450	145	PK-L-H45-250-A	142
PD-G60160-02	120	PG-AL8311520	292	PK-0-H45-500	145	PK-L-H45-250-B	140
PD-G80160-02	120	PG-GA4560-10	291	PK-0-H45-550	145	PK-L-H45-300-A	142
PD-GAM050-N02	116	PG-GA4560-20	291	PK-0-H45-600	145	PK-L-H45-300-B	140
PD-GAM050-N10	116	PG-GA6083-10	291	PK-0-H45-700	145	PK-L-H45-300-GX	143
PD-GAM050-N60	116	PG-GA6083-20	291	PK-0-H53-300	136	PK-L-H45-350-A	142
PD-GAM060-N02	116	PG-GA83115-10	291	PK-0-H53-350	136	PK-L-H45-350-B	140
PD-GAM060-N10	116	PG-GA8311520	291	PK-0-H53-400	136	PK-L-H45-350-GX	143
PD-GAM060-N60	116	PG-ST4560-10	292	PK-0-H53-450	136	PK-L-H45-400-A	142
PD-GAM080-N02	116	PG-ST4560-10A	278	PK-0-H53-500	136	PK-L-H45-400-B	140
PD-GAM080-N10	116	PG-ST4560-20	292	PK-0-H53-550	136	PK-L-H45-400-GX	143
PD-GAM080-N60	116	PG-ST4560-60	278	PK-0-H53-600	136	PK-L-H45-450-A	142
PD-GAM100-N02	116	PG-ST6083-10	292	PK-0-H53-650	136	PK-L-H45-450-B	140
PD-GAM100-N10	116	PG-ST6083-10A	278	PK-0-H53-700	136	PK-L-H45-450-GX	143
PD-GAM100-N60	116	PG-ST6083-20	292	PK-0-H53-750	136	PK-L-H45-500-A	142
PD-GAM120-N02	116	PG-ST6083-60	278	PK-0-H53-800	136	PK-L-H45-500-B	140
PD-GAM120-N10	116	PG-ST83115-10	292	PK-0-H53-900	136	PK-L-H45-500-GX	143
PD-GAM120-N60	116	PG-ST83115-10A	278	PK-0-H53-1000	136	PK-L-H45-550-A	142
PD-GAM150-N02	116	PG-ST83115-60	278	PK-0-H53-1100	136	PK-L-H45-550-B	140
PD-GAM150-N10	116	PG-ST8311520	292	PK-0H17182XP	159	PK-L-H45-550-GX	143
PD-GAM150-N60	116	PK-0-000-027	158	PK-0H17214XP	159	PK-L-H45-600-A	142
PD-GPD01-001	121	PK-0H27-3000	157	PK-0H17246XP	159	PK-L-H45-600-B	140
PD-GPD02-002	121	PK-0H27-3500	157	PK-0H17278XP	159	PK-L-H45-600-GX	143
PD-GPD03-005	121	PK-0H27-4000	157	PK-0H17310XP	159	PK-L-P20-H45-300	138
PD-LIFTNEW-LIGHT-10	114	PK-0H27-4500	157	PK-0H17342XP	159	PK-L-P20-H45-350	138
PD-LIFTNEW-LIGHT-80	114	PK-0H27-5000	157	PK-0H17406XP	159	PK-L-P20-H45-400	138
PD-LIFTNEW-MEDIUM-10	114	PK-0H30-2500	155	PK-0H17438XP	159	PK-L-P20-H45-450	138
PD-LIFTNEW-MEDIUM-80	114	PK-0H30-2500-A	156	PK-0H45250GX1	149	PK-L-P20-H45-500	138
PD-LIFTNEW-STRONG-10	114	PK-0H30-3000	155	PK-0H45250HK	150	PK-L-P20-H45-550	138
PD-LIFTNEW-STRONG-80	114	PK-0H30-3000-A	156	PK-0H45300GX1	149	PK-L-P20-H45-600	138
PD-LIFTNEW-STRONG-		PK-0H30-3500	155	PK-0H45300GX2-A	151	PK-L-P20-H45-700	138
-PLUS-10	114	PK-0H30-3500-A	156	PK-0H45300HK	150	PK-P-H45-300-GX	148
PD-LIFT-P20-LIGHT-10	114	PK-0H30-4000	155	PK-0H45350GX1	149	PK-P-H45-350-GX	148
PD-LIFT-P20-LIGHT-80	114	PK-0H30-4000-A	156	PK-0H45350GX2-A	151	PK-P-H45-400-GX	148
PD-LIFT-P20-MEDIUM-10	114	PK-0H30-4500	155	PK-0H45350HK	150	PK-P-H45-450-GX	148
PD-LIFT-P20-MEDIUM-80	114	PK-0-H35-2500	153	PK-0H45400GX1	149	PK-P-H45-500-GX	148
PD-LIFT-P20-STRONG-10	114	PK-0H35-2500	152	PK-0H45400GX2-A	151	PK-P-H45-550-GX	148
PD-LIFT-P20-STRONG-80	114	PK-0-H35-2500L	154	PK-0H45400HK	150	PK-P-H45-600-GX	148
PD-LIFT-P20-STRONG-		PK-0-H35-3000	153	PK-0H45450GX1	149	PK-PRO-H45-250	146
-PLUS-10	114	PK-0H35-3000	152	PK-0H45450GX2-A	151	PK-PRO-H45-300	146

PK-PRO-H45-350	146	PP-00GS04-06	223	PR-OB-350-18-Z	161	RS-304224-02	390
PK-PRO-H45-400	146	PP-BAR-20M	462	PR-OB-400-10	160	RS-304224-05	390
PK-PRO-H45-450	146	PP-BELT-20M	456	PR-OB-400-10-Z	161	RS-304224-06	390
PK-PRO-H45-500	146	PP-DP0105-06	222	PR-OB-400-18	160	RS-304224-14	390
PK-PRO-H45-550	146	PP-DP0105-01	222	PR-OB-450-10	160	RS-336256-01	390
PK-PRO-H45-600	146	PP-DP0105-02	222	PR-OB-450-10-Z	161	RS-336256-02	390
PK-PRO-H45-650	146	PP-DP0105-05	222	PR-OB-450-18	160	RS-336256-05	390
PK-S-H45-250	144	PP-FLAT-20M	456	PR-OB-450-80-Z	161	RS-336256-06	390
PK-S-H45-300	144	PP-GALA-20M	458	PR-OB-500-10	160	RS-336256-14	390
PK-S-H45-350	144	PP-GINO-20M	458	PR-OB-500-18	160	RS-368288-01	390
PK-S-H45-400	144	PP-GL-A48-01	224	PR-OB-550-10	160	RS-368288-02	390
PK-S-H45-450	144	PP-GL-B48-01	224	PR-OB-550-18	160	RS-368288-05	390
PK-S-H45-500	144	PP-GL-CGP-01	225	PR-OB-600-10	160	RS-368288-06	390
PK-S-H45-550	144	PP-GL-DR5-01	232	PR-OB-600-18	160	RS-368288-14	390
PK-S-H45-600	144	PP-GL-E410-01	225	PU-KEY027-20	320	RS-400320-01	390
PK-S-H45-650	144	PP-HS0006-01	227	PU-KEY027-60	320	RS-400320-02	390
PK-S-H45-700	144	PP-HS2710-01	228	PU-KEYM27-20	320	RS-400320-05	390
PM-LBFI60-01	325	PP-INGRID-20M	460	PU-KEYM27-60	320	RS-400320-06	390
PM-LBFI60-02	325	PP-LUK-00-01	235	PU-PKO-00-20	321	RS-400320-14	390
PM-LBFI60-05	325	PP-LUK-00-02	235	PU-PKO-00-60	321	RS-SZ-400-10	164
PM-LBFI60-06	325	PP-LUK-00-05	235	PZ-HCSL3D-H0-BEO	71	RS-SZ-450-10	164
PM-LBFI60-20M	325	PP-MP0055-01	221	PZ-HCSL-H0-BEO	71	RS-SZ-500-10	164
PM-LBFI80-01	325	PP-MP0055-02	221	PZ-HCSL-H0-M5	71	RS-TRIES-96-06	392
PM-LBFI80-02	325	PP-MP0055-05	221	PZ-HCSL-H0-ZEO	71	RS-TRIES-128-06	392
PM-LBFI80-05	325	PP-MP0055-06	221			RS-TRIES-160-06	392
PM-LBFI80-06	325	PP-NEO-20M	460			RS-TRIES-192-06	392
PM-LBFI80-20M	325	PP-NW09X90B	234	<b>R</b>		RS-TRIES-256-06	392
PM-NAR1004-10	242	PP-NW10X100B	234	RR-161030H01	255	RS-TRIES-320-06	392
PM-NAR1004-11	242	PP-NW10X145B	234	RR-161230H01	255		
PM-NAR1004-19	242	PP-NW12X120B	234	RR-250730H01	255		
PM-PFMH50-24	250	PP-NW14X120B	234	RR-250830H01	255		
PM-PFMH50-25	250	PP-NW14X140B	234	RR-250930H01	255	SB-A60x72-20M	499
PM-PFMH51-10	250	PP-NW14X165B	234	RR-251030H01	255	SB-A60X72-80	499
PM-PFMH55-25	250	PP-PMONT0D-22	241	RR-401230H01	255	SZ-005-00-01-AT	247
PM-PFMH61-10	250	PP-PMONT0M-01	240	RR-501030H01	255	SZ-005-00-01T	247
PM-PFMH64-25	250	PP-PMONT0M-07	240	RR-501230H01	255	SZ-008-00-01-AT	247
PM-PLFI60-05	325	PP-PMONT0M-08	240	RR-CH-OW-000	253	SZ-008-00-01T	247
PM-PLFI60-10	325	PP-PMONT0M-22	240	RS-156096-01	390		
PM-PLFI60-20	325	PP-ROD-20M	462	RS-156096-02	390	<b>U</b>	
PM-PLFI60-30	325	PP-S0L003-01T	226	RS-156096-05	390	UA-00-313128	362
PM-PLFI60-43	325	PP-S0L012-01T	227	RS-156096-06	390	UA-00-313160	362
PM-PLFI60-45	325	PP-SMART-000	234	RS-156096-14	390	UA-00-313192	362
PM-PLFI60-47	325	PP-SP0075-01	221	RS-188128-01	390	UA-00-319096	360
PM-PLFI60-49	325	PP-SP0075-02	221	RS-188128-02	390	UA-00-319128	360
PM-PLFI60-50	325	PP-SP0075-05	221	RS-188128-05	390	UA-00-319160	360
PP-00GS02-01	222	PP-SPL001-01	233	RS-188128-06	390	UA-00-326096-05	393
PP-00GS02-02	222	PP-TREE-20M	463	RS-188128-14	390	UA-00-326096-20M	393
PP-00GS02-05	222	PP-WIRE-20M	463	RS-220160-01	390	UA-00-326128-05	393
PP-00GS02-06	222	PR-OB-250-10	160	RS-220160-02	390	UA-00-326128-20M	393
PP-00GS03-01	223	PR-OB-250-18	160	RS-220160-05	390	UA-00-326160	393
PP-00GS03-02	223	PR-OB-300-10	160	RS-220160-06	390	UA-00-326160-20M	393
PP-00GS03-05	223	PR-OB-300-10-Z	161	RS-220160-14	390	UA-00-337096-20M	381
PP-00GS03-06	223	PR-OB-300-18	160	RS-272192-01	390	UA-00-337096-20M	381
PP-00GS04-01	223	PR-OB-350-10	160	RS-272192-02	390	UA-00-337128	381
PP-00GS04-02	223	PR-OB-350-10-Z	161	RS-272192-05	390	UA-00-337160	381
PP-00GS04-05	223	PR-OB-350-18	160	RS-272192-06	390	UA-00-337128-20M	381
				RS-272192-14	390	UA-00-337160	381
				RS-304224-01	390	UA-00-337160-20M	381
						UA-00-337192	381

UA-00-337192-20M	381	UA-B0-337192	361	UA-HEXI-128-10M	398	UA-PICADO-256-296-05	402
UA-00-337224	381	UA-B0-337224	361	UA-HEXI-128-20M	398	UA-PICADO-256-296-18	402
UA-00-337224-20M	381	UA-B0-337256	361	UA-HEXI-160-01	398	UA-PICADO-256-296-20M	402
UA-00-337256	381	UA-B0-337320	361	UA-HEXI-160-05	398	UA-PICADO-256-596-01	402
UA-00-337256-20M	381	UA-EXTEND-1200-10M	340	UA-HEXI-160-10M	398	UA-PICADO-256-596-05	402
UA-00-337320	381	UA-EXTEND-1200-20M	340	UA-HEXI-160-18	398	UA-PICADO-256-596-18	402
UA-00-337320-20M	381	UA-EXTEND-1200-22	340	UA-HEXI-160-20M	398	UA-PICADO-256-596-20M	402
UA-00-338128	381	UA-HEXA-32-01	400	UA-HEXI-160-60	398	UA-PICADO-320-396-01	402
UA-00-338160	381	UA-HEXA-32-05	400	UA-HEXI192-01	398	UA-PICADO-320-396-05	402
UA-00-340128	382	UA-HEXA-32-10M	400	UA-HEXI192-05	398	UA-PICADO-320-396-18	402
UA-00-340160	382	UA-HEXA-32-18	400	UA-HEXI192-10M	398	UA-PICADO-320-396-20M	402
UA-00-340192	382	UA-HEXA-32-20M	400	UA-HEXI192-18	398	UA-PICADO-352-796-01	402
UA-00-340224	382	UA-HEXA-32-22	400	UA-HEXI192-20M	398	UA-PICADO-352-796-05	402
UA-00-340320	382	UA-HEXA-96-01	400	UA-HEXI192-60	398	UA-PICADO-352-796-18	402
UA-00-347128	382	UA-HEXA-96-05	400	UA-HEXI-256-01	398	UA-PICADO-352-796-20M	402
UA-00-347160	382	UA-HEXA-96-10M	400	UA-HEXI-256-05	398	UA-STRUCTURE-128-20M	379
UA-00-347192	382	UA-HEXA-96-18	400	UA-HEXI-256-10M	398	UA-STRUCTURE-192-20M	379
UA-00-347224	382	UA-HEXA-96-20M	400	UA-HEXI-256-20M	398	UA-TREX-32-50-05	403
UA-00-347256	382	UA-HEXA-96-22	400	UA-HEXI-290-18	398	UA-TREX-32-50-20M	403
UA-00-347320	382	UA-HEXA-160-01	400	UA-HEXI-290-60	398	UA-TREX-96-150-05	403
UA-01-326096-V1	393	UA-HEXA-160-05	400	UA-HEXI-320-01	398	UA-TREX-96-150-20M	403
UA-01-326128-V1	393	UA-HEXA-160-10M	400	UA-HEXI-320-05	398	UA-TREX-224-250-05	403
UA-01-326160	393	UA-HEXA-160-20M	400	UA-HEXI-320-10M	398	UA-TREX-224-250-20M	403
UA-18-128146	361	UA-HEXA-160-22	400	UA-HEXI-320-20M	398	UA-TREX-320-350-05	403
UA-18-160178	361	UA-HEXA-192-01	400	UA-HEXI-360-18	398	UA-TREX-320-350-20M	403
UA-18-192210	361	UA-HEXA-192-05	400	UA-HEXI-360-60	398	UA-TREX-3500-05	403
UA-18-224242	361	UA-HEXA-192-10M	400	UA-HEXI-3500-05	398	UA-TREX-3500-20M	403
UA-18-256274	361	UA-HEXA-192-18	400	UA-HEXI-3500-20M	398	UM-BLOCK-CZ	436, 455
UA-18-320338	361	UA-HEXA-192-20M	400	UA-LIND-150-128-01	397	UM-BLOCK-NB	436
UA-ARS096-20	352	UA-HEXA-256-01	400	UA-LIND-150-128-05	397	UM-BLOCK-ZL	436
UA-ARS128-20	352	UA-HEXA-256-05	400	UA-LIND-150-128-18	397	UM-BUTTON-NB	436
UA-ARS160-20	352	UA-HEXA-256-10M	400	UA-LIND-150-128-20M	397	UM-BUTTON-SZ	436
UA-ARS192-20	352	UA-HEXA-256-20M	400	UA-LIND-224-496-01	397	UM-CLOUD-NB	436
UA-ARS224-20	352	UA-HEXA-256-22	400	UA-LIND-224-496-05	397	UM-CLOUD-SZ	436
UA-ARS256-20	352	UA-HEXA-320-01	400	UA-LIND-224-496-18	397	UM-CROWN-RZ	436
UA-ARS320-20	352	UA-HEXA-320-05	400	UA-LIND-224-496-20M	397	UM-FLAMING-RZ	436
UA-ARS630-20	352	UA-HEXA-320-10M	400	UA-LIND-256-296-01	397	UM-FLAMING-SZ	436
UA-B0-311096	360	UA-HEXA-320-20M	400	UA-LIND-256-296-05	397	UM-HEART-RZ	436
UA-B0-311096-20M	360	UA-HEXA-320-22	400	UA-LIND-256-296-18	397	UM-KID-C-001	438
UA-B0-311128	360	UA-HEXA-1200-05	341	UA-LIND-256-296-20M	397	UM-KID-D-001	438
UA-B0-311128-20M	360	UA-HEXA-1200-10M	341	UA-LIND-256-596-01	397	UM-KID-E-001	438
UA-B0-311160	360	UA-HEXA-1200-20M	341	UA-LIND-256-596-05	397	UM-KID-P-001	438
UA-B0-311160-20M	360	UA-HEXA-1200-22	341	UA-LIND-256-596-18	397	UM-KID-Q-001	438
UA-B0-311192	360	UA-HEXI-01	398	UA-LIND-256-596-20M	397	UM-KID-U-001	438
UA-B0-311192-20M	360	UA-HEXI-05	398	UA-LIND-320-396-01	397	UM-KID-W-001	439
UA-B0-311224	360	UA-HEXI-10M	398	UA-LIND-320-396-05	397	UM-KID-X-001	439
UA-B0-311224-20M	360	UA-HEXI-18	398	UA-LIND-320-396-18	397	UM-KID-Z-001	439
UA-B0-311256	360	UA-HEXI-20M	398	UA-LIND-320-396-20M	397	UM-STAR-NB	436
UA-B0-311256-20M	360	UA-HEXI-60	398	UA-LIND-352-796-01	397	UM-STAR-RZ	436
UA-B0-311288	360	UA-HEXI96-01	398	UA-LIND-352-796-05	397	UM-STAR-ZT	436
UA-B0-311288-20M*	360	UA-HEXI96-05	398	UA-LIND-352-796-18	397	UM-TWITT-SZ	436
UA-B0-311320	360	UA-HEXI96-10M	398	UA-LIND-352-796-20M	397	UM-TWITT-ZL	436
UA-B0-311320-20M	360	UA-HEXI96-18	398	UA-PICADO-224-496-01	402	UM-UNICORN-RZ	439
UA-B0-311480	360	UA-HEXI96-20M	398	UA-PICADO-224-496-05	402	UP-WP0728-BB	416
UA-B0-311480-20M*	360	UA-HEXI96-60	398	UA-PICADO-224-496-18	402	UP-WP0728-BK	416
UA-B0-337128	361	UA-HEXI-128-01	398	UA-PICADO-224-496-20M	402	UP-WP0728-BR	416
UA-B0-337160	361	UA-HEXI-128-05	398	UA-PICADO-256-296-01	402	UP-WP0728-BX	416

UP-WP0728-P0	417	UZ-336128-06	359	UZ-BAGIO-192-90	346	UZ-CAPRI-320-02	344
UP-WP0728-PA-04	417	UZ-336160-06	359	UZ-BAGIO-320-01	346	UZ-CAPRI-320-05	344
UP-WP0728-PA-07	417	UZ-336192-06	359	UZ-BAGIO-320-04	346	UZ-CAPRI-320-06	344
UP-WP0728-PB	417	UZ-336256-06	359	UZ-BAGIO-320-05	346	UZ-CLEO-128-01	364
UP-WP0728-PC-04	417	UZ-336320-06	359	UZ-BAGIO-320-06	346	UZ-CLEO-128-05	364
UP-WP0728-PK	417	UZ-336416-06	359	UZ-BAGIO-320-07	346	UZ-CLEO-128-06	364
UP-WP0728-PR	417	UZ-336480-06	359	UZ-BAGIO-320-11	346	UZ-CLEO-160-01	364
UP-WP0728-PX	417	UZ-682128-06	359	UZ-BAGIO-320-15	346	UZ-CLEO-160-05	364
UZ-00B224-01	395	UZ-682160-06	359	UZ-BAGIO-320-20M	346	UZ-CLEO-160-06	364
UZ-00B224-02	395	UZ-682192-06	359	UZ-BAGIO-320-90	346	UZ-CLEO-192-01	364
UZ-00B224-05	395	UZ-682224-06	359	UZ-CALABRIA160-01	383	UZ-CLEO-192-05	364
UZ-00B224-10	395	UZ-682256-06	359	UZ-CALABRIA160-06	383	UZ-CLEO-192-06	364
UZ-00B224-20	395	UZ-682320-06	359	UZ-CALABRIA192-01	383	UZ-CRA14-128	432
UZ-00B226-01	396	UZ-682416-06	359	UZ-CALABRIA192-06	383	UZ-CRA14-192	432
UZ-00B226-02	396	UZ-682480-06	359	UZ-CALABRIA224-01	383	UZ-CRA14-320	432
UZ-00B226-05	396	UZ-ABIAT-128-04	427	UZ-CALABRIA224-06	383	UZ-E6-096-01	394
UZ-00B226-10	396	UZ-ACERA-96-04	428	UZ-CAMAI-96-01	376	UZ-E6-096-05	394
UZ-00B226-20	396	UZ-ADRIN-96-04	427	UZ-CAMAI-96-02	376	UZ-E6-096-06	394
UZ-01-096-01	384	UZ-ALATR-128-04	417	UZ-CAMAI-96-06	376	UZ-E6-128-01	394
UZ-01-096-02	384	UZ-ANCON-128-01	363	UZ-CAMAI-96-09	376	UZ-E6-128-05	394
UZ-01-096-05	384	UZ-ANCON-128-05	363	UZ-CAMAI-96-10M	376	UZ-E6-128-06	394
UZ-01-128-01	384	UZ-ANCON-128-06	363	UZ-CAMAI-96-12	376	UZ-E6-160-01	394
UZ-01-128-02	384	UZ-ANCON-192-01	363	UZ-CAMAI-96-20M	376	UZ-E6-160-05	394
UZ-01-128-05	384	UZ-ANCON-192-05	363	UZ-CAMAI-96-90	376	UZ-E6-160-06	394
UZ-05-096-01	384	UZ-ANCON-192-06	363	UZ-CAMAI-128-01	376	UZ-EVER-128-20M	371
UZ-05-096-02	384	UZ-ANCON-256-01	363	UZ-CAMAI-128-02	376	UZ-EVER-128-90	371
UZ-05-096-05	384	UZ-ANCON-256-05	363	UZ-CAMAI-128-06	376	UZ-FABRICIO-128-03	367
UZ-05-128-01	384	UZ-ANCON-256-06	363	UZ-CAMAI-128-09	376	UZ-FABRICIO-128-18	367
UZ-05-128-02	384	UZ-ARCH096-AEB	426	UZ-CAMAI-128-10M	376	UZ-FABRICIO-128-20M	367
UZ-05-128-05	384	UZ-ARDEA-96-09	425	UZ-CAMAI-128-12	376	UZ-FABRICIO-192-03	367
UZ-06-128-01	386	UZ-AREZO-96-04	426	UZ-CAMAI-128-20M	376	UZ-FABRICIO-192-18	367
UZ-06-128-02	386	UZ-BAGIO-128-01	346	UZ-CAMAI-128-90	376	UZ-FABRICIO-192-20M	367
UZ-06-128-05	386	UZ-BAGIO-128-04	346	UZ-CAPRI-96-01	344	UZ-FABRICIO-320-03	367
UZ-07-096-01	386	UZ-BAGIO-128-05	346	UZ-CAPRI-96-02	344	UZ-FABRICIO-320-18	367
UZ-07-096-02	386	UZ-BAGIO-128-06	346	UZ-CAPRI-96-05	344	UZ-FABRICIO-320-20M	367
UZ-07-096-05	386	UZ-BAGIO-128-07	346	UZ-CAPRI-96-06	344	UZ-FIORD-32-03	403
UZ-12-096-04	420	UZ-BAGIO-128-11	346	UZ-CAPRI-128-01	344	UZ-FIORD-32-05	403
UZ-12-096-04N	420	UZ-BAGIO-128-15	346	UZ-CAPRI-128-02	344	UZ-FIORD-32-06	403
UZ-12-096-20M	420	UZ-BAGIO-128-20M	346	UZ-CAPRI-128-05	344	UZ-FIORD-32-10	403
UZ-13-096-01	387	UZ-BAGIO-128-90	346	UZ-CAPRI-128-06	344	UZ-FIORD-32-16	403
UZ-13-096-02	387	UZ-BAGIO-160-01	346	UZ-CAPRI-128-20M	344	UZ-FIORD-32-18	403
UZ-13-096-05	387	UZ-BAGIO-160-04	346	UZ-CAPRI-160-01	344	UZ-FIORD-32-20M	403
UZ-40-032-01	357	UZ-BAGIO-160-05	346	UZ-CAPRI-160-02	344	UZ-FLAVIO-96-01	350
UZ-40-032-02	357	UZ-BAGIO-160-06	346	UZ-CAPRI-160-05	344	UZ-FLAVIO-96-03	350
UZ-40-032-05	357	UZ-BAGIO-160-07	346	UZ-CAPRI-160-06	344	UZ-FLAVIO-96-06	350
UZ-40-032-06	357	UZ-BAGIO-160-11	346	UZ-CAPRI-160-20M	344	UZ-FLAVIO-96-16	350
UZ-40-032-20M	357	UZ-BAGIO-160-15	346	UZ-CAPRI-192-01	344	UZ-FLAVIO-96-20M	350
UZ-133128-01	355	UZ-BAGIO-160-20M	346	UZ-CAPRI-192-02	344	UZ-FLAVIO-128-01	350
UZ-133128-02	355	UZ-BAGIO-160-90	346	UZ-CAPRI-192-05	344	UZ-FLAVIO-128-03	350
UZ-133128-05	355	UZ-BAGIO-192-01	346	UZ-CAPRI-192-06	344	UZ-FLAVIO-128-06	350
UZ-133128-06	355	UZ-BAGIO-192-04	346	UZ-CAPRI-192-20M	344	UZ-FLAVIO-128-16	350
UZ-133128-20M	355	UZ-BAGIO-192-05	346	UZ-CAPRI-256-01	344	UZ-FLAVIO-128-20M	350
UZ-334128-06	358	UZ-BAGIO-192-06	346	UZ-CAPRI-256-02	344	UZ-FLAVIO-160-01	350
UZ-334160-06	358	UZ-BAGIO-192-07	346	UZ-CAPRI-256-05	344	UZ-FLAVIO-160-03	350
UZ-334192-06	358	UZ-BAGIO-192-11	346	UZ-CAPRI-256-06	344	UZ-FLAVIO-160-06	350
UZ-334256-06	358	UZ-BAGIO-192-15	346	UZ-CAPRI-256-20M	344	UZ-FLAVIO-160-16	350
UZ-334320-06	358	UZ-BAGIO-192-20M	346	UZ-CAPRI-320-01	344	UZ-FLAVIO-160-20M	350

UZ-FLAVIO-192-03	350	UZ-G2-224-01	353	UZ-NORD-160-18	364	UZ-VASTO-128-09	422
UZ-FLAVIO-192-06	350	UZ-G2-224-06	353	UZ-NORD-160-20M	364	UZ-VENICE-128-20M	366
UZ-FLAVIO-192-16	350	UZ-G2-224-20M	353	UZ-NORD-192-03	364	UZ-VENICE-128-90	366
UZ-FLAVIO-192-20M	350	UZ-GENUA128-01	383	UZ-NORD-192-18	364	UZ-VITO-160-01	347
UZ-FLAVIO-320-03	350	UZ-GENUA128-02	383	UZ-NORD-192-20M	364	UZ-VITO-160-05	347
UZ-FLAVIO-320-06	350	UZ-GENUA128-05	383	UZ-NORD-320-03	364	UZ-VITO-160-07	347
UZ-FLAVIO-320-16	350	UZ-GENUA128-20M	383	UZ-NORD-320-18	364	UZ-VITO-160-12	347
UZ-FLAVIO-320-20M	350	UZ-GENUA160-01	383	UZ-NORD-320-20M	364	UZ-VITO-160-16	347
UZ-FLOW-128-06	369	UZ-GENUA160-02	383	UZ-OCTAVIO-128-01	342	UZ-VITO-160-20M	347
UZ-FLOW-128-20M	369	UZ-GENUA160-05	383	UZ-OCTAVIO-128-06	342	UZ-VITO-288-01	347
UZ-FLOW-128-90	369	UZ-GENUA160-20M	383	UZ-OCTAVIO-128-18	342	UZ-VITO-288-05	347
UZ-FLOW-192-06	369	UZ-MARSA-64-07	419	UZ-OCTAVIO-128-20M	342	UZ-VITO-288-07	347
UZ-FLOW-192-20M	369	UZ-MARSA-64-09	419	UZ-OCTAVIO-160-01	342	UZ-VITO-288-12	347
UZ-FLOW-192-90	369	UZ-MARSA-64-10M	419	UZ-OCTAVIO-160-06	342	UZ-VITO-288-16	347
UZ-G0-128-01	380	UZ-MARSA-64-11	419	UZ-OCTAVIO-160-18	342	UZ-VITO-288-20M	347
UZ-G0-128-05	380	UZ-MARSA-64-15	419	UZ-OCTAVIO-160-20M	342	UZ-WERON-96-04	425
UZ-G0-128-06	380	UZ-MARSA-64-18	419	UZ-OCTAVIO-192-01	342	UZ-WERON-96-09	425
UZ-G0-160-01	380	UZ-MARSA-64-20M	419	UZ-OCTAVIO-192-06	342	UZ-WERON-96-12	425
UZ-G0-160-05	380	UZ-MILAN-128-01	354	UZ-OCTAVIO-192-18	342	UZ-WERON-128-04	425
UZ-G0-160-06	380	UZ-MILAN-128-05	354	UZ-OCTAVIO-192-20M	342	UZ-WERON-128-09	425
UZ-G0-192-01	380	UZ-MILAN-128-06	354	UZ-OLBIA-96-04	424	UZ-WERON-128-12	425
UZ-G0-192-05	380	UZ-MILAN-128-20M	354	UZ-OLBIA-128-04	424	UZ-WP1146-04	430
UZ-G0-192-06	380	UZ-MILAN-256-01	354	UZ-OTTO-128-06	370	UZ-Z10096-01	387
UZ-G0-256-01	380	UZ-MILAN-256-05	354	UZ-OTTO-128-20M	370	UZ-Z10096-02	387
UZ-G0-256-05	380	UZ-MILAN-256-06	354	UZ-OTTO-128-90	370	UZ-Z10096-05	387
UZ-G0-256-06	380	UZ-MILAN-256-20M	354	UZ-OTTO-160-06	370	UZ-Z10096-20M	387
UZ-G1-128-01	380	UZ-MODEN-128-01	356	UZ-OTTO-160-20M	370	UZ-Z10128-01	387
UZ-G1-128-05	380	UZ-MODEN-128-05	356	UZ-OTTO-160-90	370	UZ-Z10128-02	387
UZ-G1-128-06	380	UZ-MODEN-128-06	356	UZ-PALER-96-07	424	UZ-Z10128-05	387
UZ-G1-128-13	380	UZ-MODEN-128-20M	356	UZ-PALER-128-07	424	UZ-Z10128-20M	387
UZ-G1-128-20M	380	UZ-MODEN-160-01	356	UZ-REN096-04A	428		
UZ-G1-160-01	380	UZ-MODEN-160-05	356	UZ-RETRIS-128-04	418		
UZ-G1-160-05	380	UZ-MODEN-160-06	356	UZ-RETRIS-128-07	418	WA-MALAG-A0-01	448
UZ-G1-160-06	380	UZ-MODEN-160-20M	356	UZ-RETRIS-128-20M	418	WA-MALAG-A0-02	448
UZ-G1-160-13	380	UZ-MODEN-192-01	356	UZ-ROYAL1-96-10-03	429	WA-MALAG-A0-05	448
UZ-G1-160-20M	380	UZ-MODEN-192-05	356	UZ-ROYAL2-96-10-03	429	WA-MALAG-A0-20	448
UZ-G1-192-01	380	UZ-MODEN-192-06	356	UZ-ROYAL3-96-10-03	429	WA-MALAG-B0-01	449
UZ-G1-192-05	380	UZ-MODEN-192-20M	356	UZ-ROYAL4-96-03	429	WA-MALAG-B0-02	449
UZ-G1-192-06	380	UZ-MONA-128-01-10	351	UZ-ROYAL5-96-10-03	429	WA-MALAG-B0-05	449
UZ-G1-192-13	380	UZ-MONA-128-01-20	351	UZ-ROYAL5-128-10-03	429	WA-MALAG-B0-20	449
UZ-G1-192-20M	380	UZ-MONA-192-01-10	351	UZ-STEP-160-07	374	WB-073024-01	235
UZ-G1-256-01	380	UZ-MONA-192-01-20	351	UZ-STEP-160-20M	374	WB-073024-06	235
UZ-G1-256-05	380	UZ-MONA-256-01-10	351	UZ-TH096128-01	362	WB-073025-01	236
UZ-G1-256-06	380	UZ-MONA-256-01-20	351	UZ-TH096128-05	362	WB-073025-06	236
UZ-G1-256-13	380	UZ-MONZA160-06	351	UZ-TH096128-06	362	WB-073026-01	236
UZ-G1-256-20M	380	UZ-MONZA160-10	351	UZ-TH160192-01	362	WB-073026-06	236
UZ-G1-320-01	380	UZ-MONZA160-20	351	UZ-TH160192-05	362	WB-WS-12-010	237
UZ-G1-320-05	380	UZ-MONZA256-06	351	UZ-TH160192-06	362	WB-WS-18-010	237
UZ-G1-320-06	380	UZ-MONZA256-10	351	UZ-TH288320-01	362	WB-WS-18-020	237
UZ-G1-320-13	380	UZ-MONZA256-20	351	UZ-TH288320-06	362	WB-WS-18-060	237
UZ-G1-320-20M	380	UZ-MONZA384-06	351	UZ-TIVOL-192-01	363	WB-WS-24-010	238
UZ-G1-416-01	380	UZ-MONZA384-10	351	UZ-TIVOL-192-12	363	WB-WS-24-020	238
UZ-G1-416-05	380	UZ-MONZA384-20	351	UZ-TIVOL-192-13	363	W-CUSTOMI-60L450	218
UZ-G1-416-06	380	UZ-NORD-128-03	364	UZ-TIVOL-320-01	363	W-CUSTOMI-60L500	218
UZ-G2-160-01	353	UZ-NORD-128-18	364	UZ-TIVOL-320-12	363	W-CUSTOMI-80L450	219
UZ-G2-160-06	353	UZ-NORD-128-20M	364	UZ-TIVOL-320-13	363	W-CUSTOMI-80L500	219
UZ-G2-160-20M	353	UZ-NORD-160-03	364	UZ-VASTO-96-09	422	WG-KOSZ60-10	271

## W

WG-KOSZ60-60	271	WG-WSPOD60-60	276	W-WK080-BP-60	284	WZ-A0-K24-05	447
WG-KOSZ70-10	271	WG-WSPOD70	276	W-WK090-BP-10	285	WZ-A0-K24-07	447
WG-KOSZ70-60	271	WG-WSPOD70-10	276	W-WK090-BP-60	284	WZ-A0-K24-20	447
WG-KOSZ80-10	271	WG-WSPOD70-60	276	W-WKRP-BP-10	286	WZ-B0-K23-01	446
WG-KOSZ80-60	271	WG-WSPOD80	276	W-WKRP-BP-60	286	WZ-B0-K23-02	446
WG-KOSZ90-10	271	WG-WSPOD80-10	276	W-WKRP-VE-10	286	WZ-B0-K23-03	446
WG-KOSZ90-60	271	WG-WSPOD80-60	276	W-WKRP-VE-60	286	WZ-B0-K23-04	446
WG-KOSZM60-10	270	WG-WSPOD90	276	W-WOBU60-BP-10	281	WZ-B0-K23-05	446
WG-KOSZM60-60	270	WG-WSPOD90-10	276	W-WOBU60-BP-60	280	WZ-B0-K23-06	446
WG-KOSZM70-10	270	WG-WSPOD90-60	276	W-WOBU70-BP-10	281	WZ-B0-K23-07	446
WG-KOSZM70-60	270	WK-CAM-15-12-D	248	W-WOBU70-BP-60	280	WZ-B0-K23-20	446
WG-KOSZM80-10	270	WK-CAM-15-13-D	248	W-WOBU80-BP-10	281	WZ-B0-K24-01	447
WG-KOSZM80-60	270	WK-CAM-15-DOW63X31-KPL-1T		W-WOBU80-BP-60	280	WZ-B0-K24-02	447
WG-KOSZM90-10	270		249	W-WOBU90-BP-10	281	WZ-B0-K24-03	447
WG-KOSZM90-60	270	WK-CAM-15-DOW63X35-KPL-1T		W-WOBU90-BP-60	280	WZ-B0-K24-04	447
WG-KOSZR60-10	272		249	W-WSPD60-BP-10	283	WZ-B0-K24-05	447
WG-KOSZR60-60	272	WK-CAM-15-DOW63X39-KPL-1T		W-WSPD60-BP-60	282	WZ-B0-K24-07	447
WG-KOSZR70-10	272		249	W-WSPD70-BP-10	283	WZ-B0-K24-20	447
WG-KOSZR70-60	272	WK-CAM-15-DOW63X45-KPL-1T		W-WSPD70-BP-60	282	WZ-C0-K24-01	448
WG-KOSZR80-10	272		249	W-WSPD80-BP-10	283	WZ-C0-K24-02	448
WG-KOSZR80-60	272	WK-CF0750-01	249	W-WSPD80-BP-60	282	WZ-C0-K24-03	448
WG-KOSZR90-10	272	WK-CF6450-01	249	W-WSPD90-BP-10	283	WZ-C0-K24-04	448
WG-KOSZR90-60	272	WK-D0320-001*	247	W-WSPD90-BP-60	282	WZ-C0-K24-05	448
WG-POBUW60-10	273	WK-D0325-001*	247	WW-WSD250-01B	290	WZ-C0-K24-20	448
WG-POBUW60-60	273	WK-D0330-001*	247	WW-WSD300-01B	290	WZ-CAPITAL-18	444
WG-POBUW70-10	273	WK-D0416-001	247	WW-WSD350-01B	290	WZ-CAPITAL-20M	444
WG-POBUW70-60	273	WK-D0425-001*	247	WW-WSD400-01B	290	WZ-CORDOBA-01	442
WG-POBUW80-10	273	WK-D0430-001	247	WW-WSD450-01B	290	WZ-CORDOBA-06	442
WG-POBUW80-60	273	WK-D0440-001	247	WW-WSD500-01B	290	WZ-CORDOBA-20M	442
WG-POBUW90-10	273	WK-D0460-001	247	WW-WSL250-01	289	WZ-CORUNA-D-04	450
WG-POBUW90-60	273	WK-D3516-001	247	WW-WSL300-01	289	WZ-CORUNA-D-07	450
WG-POBUWM60-10	274	WK-D3530-001	247	WW-WSL350-01	289	WZ-CORUNA-D-17	450
WG-POBUWM60-60	274	WK-DOW63X31G-D	248	WW-WSL400-01	289	WZ-CORUNA-D-20M	450
WG-POBUWM70-10	274	WK-DOW63X35B-D	248	WW-WSL450-01	289	WZ-CORUNA-M-04	451
WG-POBUWM70-60	274	WK-DOW63X39-D	248	WW-WSL500-01	289	WZ-CORUNA-M-07	451
WG-POBUWM80-10	274	WK-DOW63X45B-D	248	WW-WSL000-01	288	WZ-CORUNA-M-17	451
WG-POBUWM80-60	274	WK-SZ-AS-400-10	220	WW-WSP000-01	288	WZ-CORUNA-M-20M	451
WG-POBUWM90-10	274	WK-SZ-AS-400-60	220	WW-WSP000-01	288	WZ-CRAFT-04	453
WG-POBUWM90-60	274	WK-SZ-AS-500-10	220	WW-WUBR00-01	289	WZ-CRAFT-07	453
WG-PRZEG60-10	275	WK-SZ-AS-500-60	220	WW-ZWBUT2P-10	290	WZ-CRAFT-15	453
WG-PRZEG60-60	275	WK-SZ-AS-600-10	220	WW-ZWBUT2P-20	290	WZ-CRAFT-20M	453
WG-PRZEG70-10	275	WK-SZ-AS-600-60	220	WZ-00-K24-04	454	WZ-E-018-01	450
WG-PRZEG70-60	275	WK-SZ-AS-800-10	220	WZ-804-20-01	444	WZ-E-018-02	450
WG-PRZEG80-10	275	WK-SZ-AS-800-60	220	WZ-804-20-05	444	WZ-E-018-05	450
WG-PRZEG80-60	275	WK-SZ-AS-900-10	220	WZ-804-20-06	444	WZ-E-018-06	450
WG-PRZEG90-10	275	WK-SZ-AS-900-60	220	WZ-A0-K23-01	446	WZ-E-018-20M	450
WG-PRZEG90-60	275	WM-BALL-CZ-B	455	WZ-A0-K23-02	446	WZ-K2201-01	443
WG-RDRO-10	277	WM-BLOCK-NB	455	WZ-A0-K23-03	446	WZ-K2201-06	443
WG-RDRO-60	277	WM-BLOCK-ZL	455	WZ-A0-K23-04	446	WZ-K2201-CZ	443
WG-RDRP-10	277	WM-CLOUD-NB	455	WZ-A0-K23-05	446	WZ-K2202-01	443
WG-RDRP-60	277	WM-CLOUD-SZ	455	WZ-A0-K23-06	446	WZ-K2202-06	443
WG-RRPSET-A-10	277	WM-UNICORN-RZ	455	WZ-A0-K23-07	446	WZ-K2202-CZ	443
WG-RRPSET-A-60	277	W-WK060-BP-10	285	WZ-A0-K23-20	446	WZ-MADRYT-04	452
WG-RRPSET-B-10	277	W-WK060-BP-60	284	WZ-A0-K24-01	447	WZ-MADRYT-07	452
WG-RRPSET-B-60	277	W-WK070-BP-10	285	WZ-A0-K24-02	447	WZ-MADRYT-15	452
WG-WSPOD60	276	W-WK070-BP-60	284	WZ-A0-K24-03	447	WZ-MADRYT-20M	452
WG-WSPOD60-10	276	W-WK080-BP-10	285	WZ-A0-K24-04	447	WZ-MALAG-C0-01	449

WZ-MALAG-C0-02	449	ZM-DCHC09-3DZEO	71	ZIP-BICJ090ZE-B	90	ZIP-CONL08-BE	87
WZ-MALAG-C0-05	449	ZM-ECHC07-3DBEO	77	ZIP-BICJ270ZE-B	91	ZIP-CONL08-ZE	87
WZ-MALAG-C0-20	449	ZM-ECHC07BEO	74	ZIP-BICJ280ZE-B	90	ZIP-CONL09-BE	87
WZ-ORVIE-A0-09	453	ZM-ECHC07H04-BE	76	ZIP-BICJ290ZE-B	90	ZIP-CONL09-ZE	87
WZ-SCTYLPR-BWK	242	ZM-ECHC07ZEO	74	ZIP-BICN070BEO	89	ZIP-JUNIOR-00	105
WZ-SCTYLPR-WK	242	ZM-ECHC08-3DBEO	77	ZIP-BICN070ZEO	89	ZIP-KT30H2-BE	92
WZ-TOLED-A0-01	440	ZM-ECHC08BEO	74	ZIP-BICN072BEO	89	ZIP-KT45H2-ZE	92
WZ-TOLED-A0-02	440	ZM-ECHC08H04-BE	75	ZIP-BICN072ZEO	89	ZIP-KT90H2-BE	93
WZ-TOLED-A0-05	440	ZM-ECHC08ZEO	74	ZIP-BICN080BEO	89	ZIP-KT90H2-ZE	93
WZ-TOLED-A0-06	440	ZM-ECHC09-3DBEO	76	ZIP-BICN080ZEO	89	ZIP-KT135H2BE	94
WZ-TOLED-A0-20M	440	ZM-ECHC09BEO	73	ZIP-BICN082BEO	89	ZIP-KT135H2ZE	94
WZ-TOLED-B0-01	440	ZM-ECHC09H04-BE	75	ZIP-BICN082ZEO	89	ZIP-KT165H2BE	94
WZ-TOLED-B0-02	440	ZM-ECHC09ZEO	73	ZIP-BICN090BEO	88	ZIP-KT165H2ZE	94
WZ-TOLED-B0-05	440	ZM-HCKT30-BE-S	81	ZIP-BICN090ZEO	88	ZIP-KT0270-BE	104
WZ-TOLED-B0-06	440	ZM-HCKT30-ZE-S	81	ZIP-BICN092BEO	88	ZIP-KTK90H6BE	93
WZ-TOLED-B0-20M	440	ZM-HCKT45-3DBEO-S	82	ZIP-BICN092ZEO	88	ZIP-KTK90H6ZE	93
WZ-TOLED-C0-01	441	ZM-HCKT45-BE-S	81	ZIP-BIDI07-3DBEO	86	ZIP-P07H045BE	98
WZ-TOLED-C0-02	441	ZM-HCKT45-ZE-S	81	ZIP-BIDI08-3DBEO	86	ZIP-POH045BEO	98
WZ-TOLED-C0-05	441	ZM-HCKT90-3DBEO-S	83	ZIP-BIDI09-3DBEO	85	ZIP-POH045ZEO	98
WZ-TOLED-C0-06	441	ZM-HCKT90-BE-S	82	ZIP-CIBI7H0ZE	101	ZIP-RALUH2-00	103
WZ-TOLED-C0-20M	441	ZM-HCKT90-ZE-S	82	ZIP-CIBI8H0ZE	101	ZIP-SKR-00-80	106
WZ-WALENCIA-01	442	ZM-HCKT155BE	84	ZIP-CIBI9H0ZE	100	ZT-HF-01-D00	104, 105
WZ-WALENCIA-06	442	ZM-HCKT155ZE	84	ZIP-CIG-070ZE	102	ZZ-16-103-01-S	329
WZ-WALENCIA-20M	442	ZM-HCKT165-3DBEO-S	85	ZIP-CIG-07UZE	102	ZZ-20-103-01-S	329
		ZM-HCKT165BE-S	84	ZIP-CIG-090ZE	102	ZZ-30-103-01-S	329
		ZM-HCKT165ZE-S	84	ZIP-CIG-09UBE	102	ZZ-B0-105-01-S	328
ZC-GTV-12-00	106	ZM-HCKTK90-ZE	83	ZIP-CIG-09UZC	102	ZZ-BA-SK0-01-S	331
ZC-GTV-14-00	106	ZM-HCRALU9BE	103	ZIP-CIG-09UZE	102	ZZ-BA-SK0-PR	331
ZK-FORCE-KPL	243	ZM-HCSL07-3D	70	ZIP-CIG-170ZE	102	ZZ-C1-288-01-S	332
ZK-FORZA-ZAS-KPL-010	245	ZM-HCSL08-3D	70	ZIP-CIG-17UZE	102	ZZ-C5-288-01-S	332
ZK-FORZA-ZAS-KPL-020	245	ZM-HCSL09-3D	69	ZIP-CIG-190ZE	102	ZZ-C6-288-01-S	332
ZK-FORZA-ZAW-KPL	244	ZM-INHC070BEO	80	ZIP-CIG-19UZE	102	ZZ-C8-288-01-S	332
ZK-R1-KPL-10	244	ZM-INHC070ZEO	80	ZIP-CIHC070ZE	100	ZZ-CF-138-01	327
ZK-ZAW-R0-10	243	ZM-INHC080BEO	80	ZIP-CIHC080ZE	99	ZZ-G0-328-01	331
ZK-ZAW-R0-30	243	ZM-INHC080ZEO	80	ZIP-CIHC090ZE	99	ZZ-KLMASTER	327
ZM-CNHC07BR2	79	ZM-INHC090BEO	79	ZIP-COCA450-BE	95	ZZ-KM-138-01-S	326
ZM-CNHC08BR2	78	ZM-INHC090ZEO	79	ZIP-COCA450-BE-F	96	ZZ-M0-201-01-S	330
ZM-CNHC09BR2	78	ZM-KT45H2-BE	92	ZIP-COCA450-ZE	95	ZZ-SP-105-05	332, 539
ZM-COVERHCSL-SET	71	ZM-OT-Standard	69	ZIP-COCA450-BE	96	ZZ-SP-KLMASTER	332
ZM-DCHC07-3DBEO	72	ZM-SZABLON-ZAW	107	ZIP-COCA7450-BE-F	97	ZZ-SZ-409-01-S	329
ZM-DCHC07-3DZEO	72	ZM-OT-heavy	69	ZIP-COCA8450-BE	95	ZZ-Z0-202-01-S	330
ZM-DCHC08-3DBEO	72	Z-0GR-KAT91		ZIP-COCA8450-BE-F	97	ZZ-ZN-138-01	326
ZM-DCHC08-3DZEO	72	ZIP-BICJ070ZE-B	91	ZIP-CONL07-BE	88	ZZ-ZN-338-01-S	328
ZM-DCHC09-3DBEO	71	ZIP-BICJ080ZE-B	90	ZIP-CONL07-ZE	88		





Dieser Produktkatalog wurde von GTV Poland vorbereitet. Wegen der ständigen Entwicklung unseres Sortiments zum Zwecke seiner Anpassung an die Marktund Rechtsanforderungen behält GTV Poland sich das Recht vor, das im Katalog dargestellte Sortiment zu ändern. Der Katalog stellt kein Angebot im Sinne des polnischen Zivilgesetzbuches dar. Die tatsächlichen Produkte können von den im Katalog enthaltenen Fotos und Zeichnungen abweichen. GTV Poland behält sich das Recht auf Änderungen und Druckfehler vor.

Ce catalogue de produits a été préparé par GTV Poland. En raison du développement continu de nos produits, pour répondre aux exigences du marché et aux exigences légales, GTV se réserve le droit de modifier la gamme de produits indiquée dans ce catalogue. Ce catalogue ne constitue pas une offre au sens du Code civil polonais. Les produits réels peuvent différer de ceux indiqués sur les photos et les dessins. GTV Poland se réserve le droit d'apporter des modifications et des erreurs d'impression.

Este catálogo de productos ha sido preparado por GTV mediante la constante mejora de su oferta, conforme a las exigencias legales y de mercado. GTV Poland, se reserva el derecho a introducir en él cambios sin previo aviso. La publicación presentada no es una oferta conforme al Código Civil. Ciertos productos pueden diferenciarse de las fotografías y dibujos incluidos en la publicación. GTV Poland se reserva el derecho de cambios y errores de impresión.



# GTV

ul. Przejazdowa 21  
05-800 Pruszków  
Poland

 +48 22 44 47 272

 +48 22 44 47 366  
+48 22 44 47 331

 +48 22 44 47 391

 +48 22 44 47 379

 +420 591 160 091

 +48 22 4447 523

 +375 291 504 626  
+48 22 4447 529

 +48 22 4447 216

 +48 22 4447 586

 +48 22 4447 525

 +48 22 4447 301  
+48 22 4447 586

 тел: 8-495-640 15 88

 GTV Croatia d.o.o  
Roberta Frangeša Mihanovića 9  
10110 Zagreb  
+ 385 1 798 8089

 GTV Czech Distribution s.r.o.  
CTPark Ostrava, Na Rovince 879  
720 00 Ostrava-Hrabová  
Česká republika  
+420 591 160 092  
+420 727 800 362  
+420 725 715 142

 GTV España Herrajes e Iluminación,  
S.L., Avenida Aragón 30, Planta 8  
46021 Valencia (España)  
+ 34 960 468 666  
+ 48 22 444 73 77

fax: +48 22 444 75 01  
e-mail: [info@gtv.com.pl](mailto:info@gtv.com.pl)  
[www.gtv.com.pl](http://www.gtv.com.pl)

